



Eickemeyer headquarters in Tuttlingen Germany

World class veterinary equipment

Welcome to the latest version of the EICKEMEYER catalogue. We have added more products, and we hope you will find it interesting to browse through this buying guide for the state-of-the-art veterinarian. We believe it represents a perfect blend of modern technology and traditional instruments.

This particular catalogue features instruments and equipment which will be particularly suitable for small animal and equine practitioners, clinics and universities.

We would also like to draw your attention to the unique EICKEMEYER Veterinary Continuing Education Centre. Veterinary professionals from all over the world attend our courses and benefit from the multicultural exchange of ideas; judging by the number of repeat attendances, they are a great success.

This Continuing Education programme is a sign of our long-term commitment to the quality and development of veterinary science and surgery.



Alexander, Gisela and Wolfgang Sprung

The best advice, the best service

Our Head Office is in Tuttlingen, Germany – known the world over as the home of fine instrument craftsmanship. Founded in 1961 by Walter Eickemeyer, the company has become a leader in veterinary equipment distribution.

We have a range of 5000 products in stock; we can supply everything from individual high-quality instruments to a fully-equipped clinic.



Eickemeyer's showroom in Tuttlingen

Our renowned customer service revolves around an outstanding team of friendly, well-trained support staff to answer any questions you may have. Furthermore, our risk-free policy allows you to return any goods without quibble within 14 days of purchase.

We are also highly accessible; our Customer Support phone lines are manned from 09:00 to 17:30 and our answering service is available at all other times. Alternatively, you can access our online ordering service 24/7 at www.eickemeyer.de

The world's best veterinary products, the best local practices

For nearly 50 years Eickemeyer have become experts not just in the science of veterinary medicine, but also in how to build and grow a successful practice. We have always sought to supply the finest instruments and equipment available, carefully sourcing the best and most practical products from all around the world. And where we can't find a product which meets our exacting quality and value criteria, we design and make our own.

Our Professional Support Team has worked with thousands of veterinarians in all kinds of practices. We know what works and what doesn't. We take the time to listen to your needs and to find solutions to the challenges of modern veterinary medicine. After all, your success is our success.



Founder Walter Eickemeyer

We are very excited about the future of this industry, and about our role in it. That future is tightly bound to our ever-expanding family of loyal customers. We are here to support and grow your business with you, assisting your efforts to raise standards in animal health and welfare around the world.

Global

We source worldwide to find the best quality products at the best prices

Veterinary products

We only deal with the veterinary market, so we have decades of experience to support you on a daily basis.

Local

As a family company we try harder every day to meet and exceed your expectations.

Practices

Your practice is a place dedicated to the wellbeing of all animals. This is central to everything we do.

Continuing Education Centre

Eickemeyer Courses - State-of-the-art training

At the EICKEMEYER training centre in Germany we offer superb training and refresher courses. Theory lectures, practical demonstrations and hands-on veterinary seminars in small groups provide the maximum learning in the minimum time. High tech lecture facilities and full operating theatre facilities make training easy, convenient and practical.

Since 1985 about 10,000 veterinarians have attended EICKEMEYER courses; only the world's best speakers are invited to address them. The objective is to improve your diagnostic and surgical skills; while theory is very important, what you try for yourself under the supervision of our course leaders is what will make you a better veterinary surgeon.

Small groups guarantee maximum learning; so popular are these courses some vets have attended more than 30.

We look forward to welcoming you to Tuttlingen.

EICKEMEYER courses – intensive, productive, unique.

Detailed course programme available on request.



Hands-on training sessions



Full operating theatre facilities



Practical demonstrations in small groups



Top: Reception area

Bottom: Bistro

“
perfectly organised overall”
and executed at a high level
Dr E. from N

“
congratulations on a”
very successful course
Dr P. from L

“
I cannot imagine
anything could be
improved, congratulations”
Dr K. from F

1. Validity

For our deliveries the following business terms and conditions of sale are exclusively valid, unless otherwise agreed in writing. We do not accept conflicting general business terms, even if we have not expressly rejected them.

2. Prices

Prices are subject to change without prior notice. All prices quoted are ex works Tuttlingen.

3. Shipping/Freight

For all customers outside Germany charges for packing and freight are at buyer's expense.

4. Minimum Orders

We require a minimum order of € 30.– from our retail customers, € 250.– from our wholesale customers.

5. Payment terms

We require payment in advance for all international orders. Freight and shipping charges will be added unless otherwise stated. We accept wire transfers, VISA, MASTERCARD, UC as payments. All goods remain property of EICKEMEYER until paid in full.

6. Claims

Every effort has been made to pack your order with great care. Please inspect the merchandise thoroughly for any loss or damage immediately on receipt and file claim with the forwarding agent. Concealed loss or damage must be reported within 3 days upon receipt.

7. Returns

No returns are accepted without prior notice. Please call customer service to obtain your RAC No. We reserve the right to examine returned goods before issuing credit. A 15 % restocking fee will be charged for all returned goods. Special order products or goods sold on a non-return basis may not be returned. Returns must be made within 21 days of the invoice date.

8. Risk

All shipments are being dispatched at the buyer's risk, even in case of "carriage paid" delivery.

9. Applicable Law

All contracts are subject to German law. Exclusive court of jurisdiction is Tuttlingen.

10. Customer Service

Our friendly and well-trained staff is happy to assist you in any way. Even if you are looking for something not in our range of products we will do our best to help you.

11. Showroom

If you are in the vicinity of Tuttlingen, we would be very pleased to have you visit us. Many of the items in our catalog are best evaluated in your own hands. You will find almost everything on display in our 400m² showroom.

12. Education

Experienced national and international speakers help you to learn the latest diagnosis and surgery techniques in a friendly atmosphere.

13. After Sale Service

Our Service Team will carry out all repairs quickly and reliably.

14. Online Ordering

Our website allows you to choose from more than 5.000 products and also to check availability. Check out our refurbished equipment site for bargains. There is always a special on our site.

15. Specials

In our specials we offer you the best deals around. Just check your mailbox.

16. Product range

Your single resource for a full spectrum of veterinary equipment and supplies offers you more than 5.000 quality products.

Order- and Info-Hotline:

Phone: +49 74 61 /9 65 80-55

Fax: +49 7461196580-91

E-Mail: export@eickemeyer.de

Internet: www.eickemeyer.de

www.eickemeyer.de

Our website is dedicated to giving your clinic the service it demands:

- Online ordering
- Stock availability
- Information on over 5,000 products
- Online specials
- Auctions
- Continuing education
- Refurbished equipment
- News



DIA-Diagnostic Imaging Atlas

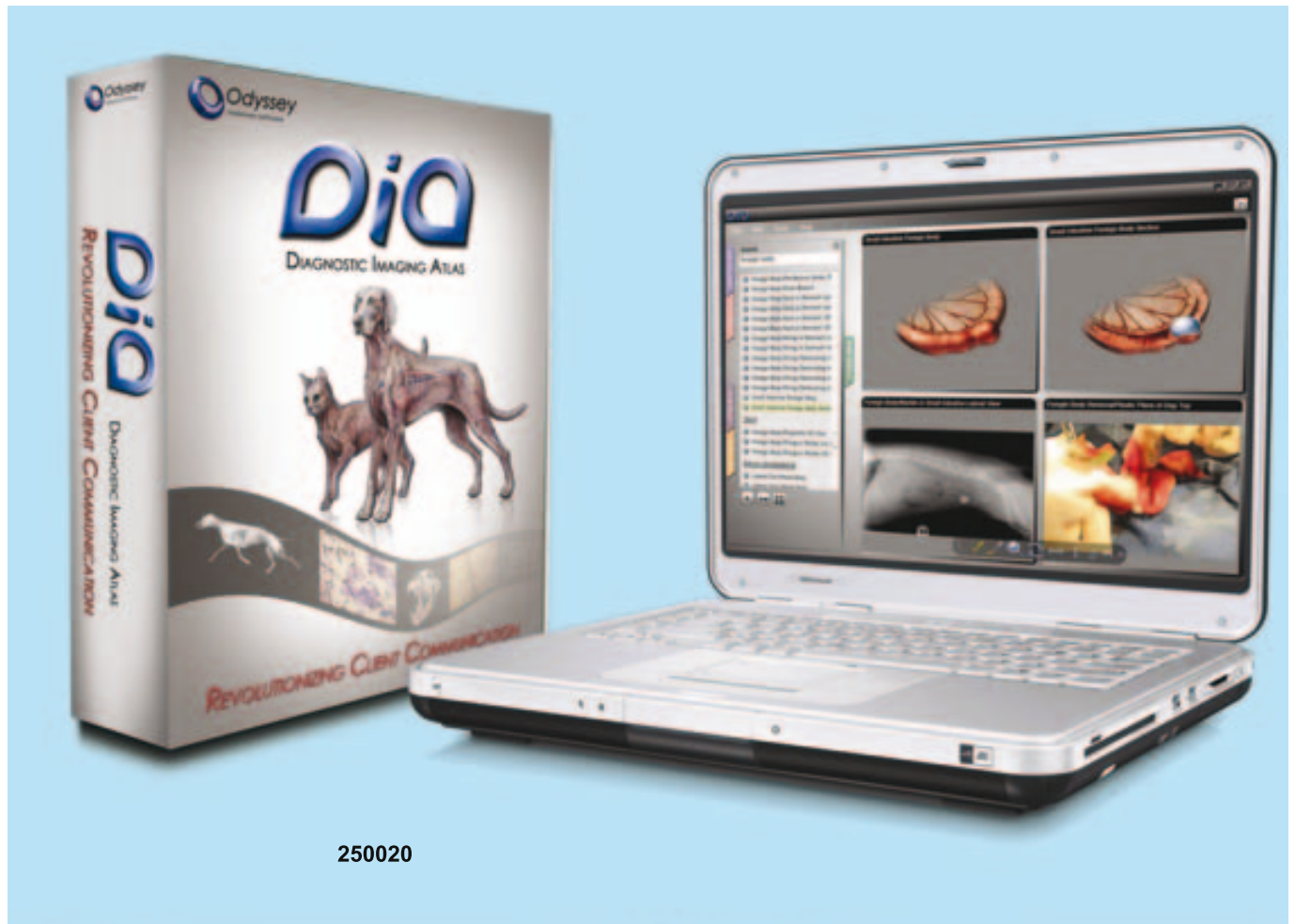

250020

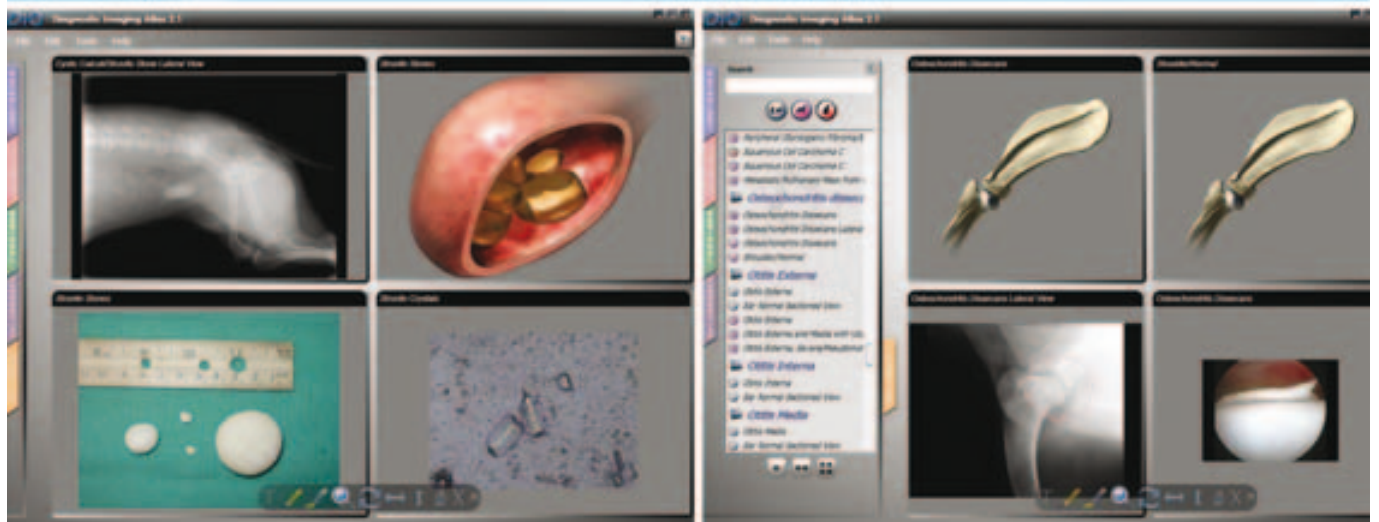

DIA-DIAGNOSTIC IMAGING ATLAS – REVOLUTIONIZING CLIENT COMMUNICATION

If a picture is worth a thousand words, then DIA is worth over one million!

This exciting and innovative software allows veterinarians and their staff to better illustrate conditions to clients. There are over 1500 Surgical Animations, Radiographs, Ultrasounds, Endoscopy Images and Clinical Images combined within DIA. The content is the result of contributions from leading board certified specialists.

No more scrambling for books or sketching out conditions or procedures on a piece of paper. This program will drastically improve your ability to validate your diagnostic findings and justify in-hospital and referral procedures. Using cutting edge graphics and imagery, your clients will be amazed with the insight you can provide into their pets health and well being.

Diagnostic Imaging Licence for up to 3 work stations

250020

Additional 2 work places licence

250021

Additional 5 work places licence

250022

Support and update service for 12 months

250023

STANDARD Scalpel Handles, Scalpel Blades, BAYHA Scalpel Handle

STANDARD SCALPEL HANDLES

- ergonomic design
- precise cutting
- easily changeable blades
- attractive price

No. 3, small, for STANDARD Scalpel Blades size 10–15

100503

No. 4, large, for STANDARD Scalpel Blades size 18–23

100504

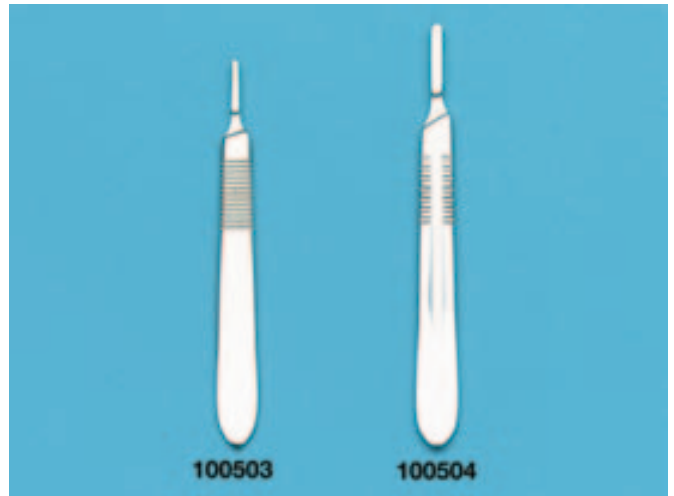

STANDARD SCALPEL BLADES

- scalpel handle No. 3 for blades size 10–15
- scalpel handle No. 4 for blades size 18–23
- excellent cutting edges
- wide range of different blades
- individually foil packed (sterile)
- attractive price
- 100/box

Size 10

100710

Size 11

100711

Size 13

100713

Size 15

100715

Size 18

100718

Size 20

100720

Size 21

100721

Size 22

100722

Size 23

100723

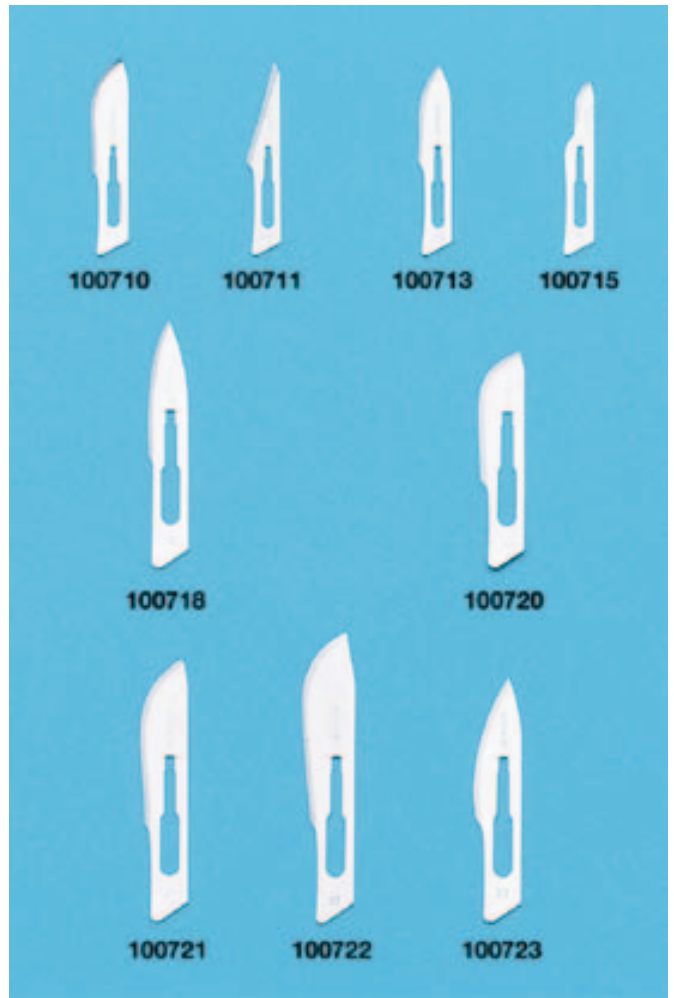

BAYHA SCALPEL HANDLE

- ergonomic design
- patented blade changing system
- easily removable blades
- precise cutting

BAYHA Scalpel Handle, No. 1

101201



MICRO Scalpel Handles, Scalpel Blades, Scissors



BAYHA SCALPEL BLADES

- fits on all BAYHA scalpel handles
- changing blades made easy
- individually foil packed (sterile)
- 12/box
- extremely sharp

Size 19

101519

Size 21

101521

Size 22

101522

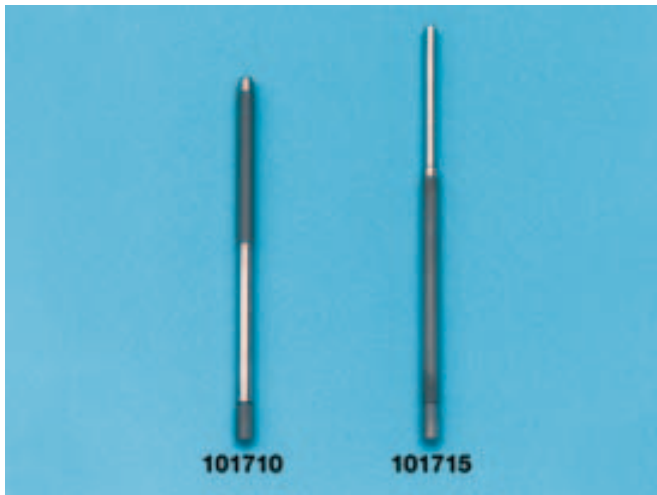

MICRO SCALPEL HANDLES

- ergonomic pen-shaped handle
- for precise cutting e.g. cornea or spinal surgery
- highest quality stainless steel
- changing blades made easy

10cm

101710

15.5cm

101715

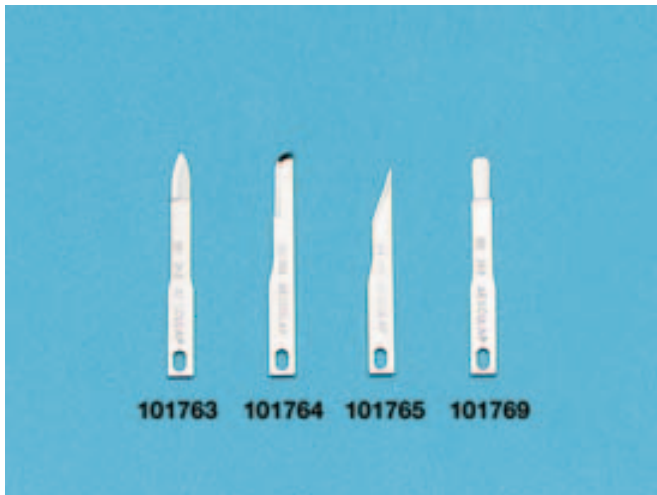

MICRO SCALPEL BLADES

- for eye-, neuro- and microsurgery
- extra strong blades for precise cutting
- razor-sharp
- individually foil packed (sterile)
- 25/box

Size 63

101763

Size 64

101764

Size 65

101765

Size 69

101769



IRIS SCISSORS

- ideal for eye surgery e.g. conjunctiva or cornea
- for precise incisions

11.5cm, straight, sharp/sharp,TC, fine

110011

11.5cm, curved, sharp/sharp,TC, fine

110111

9cm, straight, sharp/sharp, fine

110609

11cm, straight, sharp/sharp, fine

110611

9cm, curved, sharp/sharp, fine

110709

11cm, curved, sharp/sharp, fine

110711

STEVENS AND PROBE-POINTED SCISSORS

STEVENS, 11cm, straight, blunt/blunt
110811

STEVENS, 11cm, curved, blunt/blunt
110911

11.5cm, straight, 1 probe-pointed blade
111011

11.5cm, straight, 2 probe-pointed blades
111012

**DRESSING SCISSORS WITH TUNGSTEN CARBIDE INSERTS (TC)**

- permanent cutting edge
- extremely durable due to inserted Tungsten Carbide cutting edges
- precise cutting

14.5cm, straight, sharp/sharp, TC
113414

14.5cm, straight, sharp/blunt, TC
113214

14.5cm, curved, sharp/blunt, TC
113314

16.5cm, curved, sharp/blunt, TC
113316

**SCISSORS, HEAVY MODEL**

- strong and accurate cutting
- extremely durable

16cm, laterally curved, blunt/blunt
114716

16cm, curved, blunt/blunt
114916

16cm, straight, sharp/blunt
115016

16cm, straight, blunt/blunt
114816



Scissors



VET Eickemeyer®

Visit us on our website
www.eickemeyer.de

DRESSING SCISSORS

- sharp cutting
- premium quality
- highest quality stainless steel

14.5cm, straight, blunt/blunt

114014

16.5cm, straight, blunt/blunt

114016

14.5cm, curved, blunt/blunt

114114

16.5cm, curved, blunt/blunt

114116

14.5cm, straight, sharp/blunt

114214

16.5cm, straight, sharp/blunt

114216

14.5cm, curved, sharp/blunt

114314

16.5cm, curved, sharp/blunt

114316

14.5cm, straight, sharp/sharp

114414

14.5cm, curved, sharp/sharp

114514

16.5cm, curved, sharp/sharp

114516

Incision Scissors, 16.5cm, straight, sharp/
probe-pointed

114616

14cm, straight, blunt/blunt, ECONOMY

970014

16cm, straight, blunt/blunt, ECONOMY

970016

14cm, curved, blunt/blunt, ECONOMY

970114

16cm, curved, blunt/blunt, ECONOMY

970116

14cm, straight, sharp/blunt, ECONOMY

970214

16cm, straight, sharp/blunt, ECONOMY

970216

14cm, curved, sharp/blunt, ECONOMY

970314

16cm, curved, sharp/blunt, ECONOMY

970316

14cm, straight, sharp/sharp, ECONOMY

970414

16cm, straight, sharp/sharp, ECONOMY

970416

14cm, curved, sharp/sharp, ECONOMY

970514

Incision Scissors, 14.5cm, straight, sharp/
probe-pointed, ECONOMY

981214

METZENBAUM / DISSECTING SCISSORS WITH TUNGSTEN CARBIDE INSERTS (TC)

- elegant and light form
- extremely durable due to inserted Tungsten Carbide cutting edges
- precise cutting accuracy

11.5cm, straight, blunt/blunt, TC

- delicate

116011

11.5cm, curved, blunt/blunt, TC

- delicate

116111

METZENBAUM, 14.5cm, straight, TC

116214

METZENBAUM, 18cm, straight, TC

116218

METZENBAUM, 14.5cm, curved, TC

116314

METZENBAUM, 14.5cm, curved, with serrated cutting edge, TC, wave cut

- prevents tissue slippage

116315

METZENBAUM, 18cm, curved, TC

116318

METZENBAUM-FINO, 14.5cm, straight, TC

- very delicate

116414

METZENBAUM-FINO, 14.5cm, curved, TC

- very delicate

116514

MAYO SCISSORS WITH TUNGSTEN CARBIDE INSERTS (TC)

- general purpose surgical scissors
- for dissection and cutting of firm tissue.

MAYO, 14.5cm, straight, blunt/blunt, TC

117214

MAYO, 14.5cm, curved, blunt/blunt, TC

117314

MAYO, 14.5cm, curved, blunt/blunt, with serrated cutting edge, TC

- prevents tissue slippage

117315

MAYO-STILLE, 14cm, straight, blunt/blunt, TC

117414

MAYO-STILLE, 17cm, straight, blunt/blunt, TC

117417



VET Eickemeyer®

Large variety of surgery-
and examination tables



VET Eickemeyer®

Quality products
for the veterinary profession
since 1961

Scissors, Sharpen scissors



VET Eickemeyer®

Your reliable source for
innovative products



VET Eickemeyer®

Our service – Your benefit

Our skilled instrument makers can fully inspect your instruments and take the necessary steps to return them to an excellent working condition.

METZENBAUM SCISSORS

METZENBAUM, 11.5cm, straight, blunt/blunt
118011

METZENBAUM, 11.5cm, curved, blunt/blunt
118111

METZENBAUM, 14.5cm, straight, blunt/blunt
118214

METZENBAUM, 18cm, straight, blunt/blunt
118218

METZENBAUM, 14.5cm, curved, blunt/blunt
118314

METZENBAUM, 18cm, curved, blunt/blunt
118318

METZENBAUM-FINO, 14.5cm, straight, blunt/
blunt

- very delicate
118414

METZENBAUM-FINO, 14.5cm, curved, blunt/
blunt

- very delicate
118514

METZENBAUM, 14cm, straight, blunt/blunt,
ECONOMY

970614

METZENBAUM, 14cm, curved, blunt/blunt,
ECONOMY

970714

MAYO SCISSORS/ENTEROTOMY SCISSORS

MAYO, 14cm, straight, blunt/blunt
118614

MAYO, 14cm, curved blunt/blunt
118714

MAYO, 17cm, curved, blunt/blunt
118717

MAYO-STILLE, 14cm, straight, blunt/blunt
118814

MAYO-STILLE, 14cm, curved, blunt/blunt
118914

Enterotomy Scissors, 14.5cm, straight, sharp/
probe-pointed

119014

Enterotomy Scissors, 21cm, straight, blunt/
probe-pointed

119021

MAYO, 14cm, curved, blunt/blunt, ECONOMY
970914

BANDAGE AND PLASTER SCISSORS

LISTER, 18cm, TC

122018

LISTER, 14cm

123014

LISTER, 18cm

123018

Universal Scissors with plastic handles, 18cm, autoclavable

123118

BRUNS, 24cm, serrated cutting edge

123224

SEUTIN, 23cm

123323



OSCILLATING SAW

- removable, autoclavable head
- can be used as a surgical oscillating saw
- lightweight
- high power (500W)
- silent running
- secure and accurate cutting

Oscillating Saw with two Tungsten Saw Blades, D = 50 / 65mm

123500

Shroud, autoclavable

not illustrated

123570

Saw Blade, Tungsten Carbide, D = 50mm

123550

Saw Blade, Tungsten Carbide, D = 65mm

123565

Saw Blade, Tungsten Carbide, width = 65mm, length = 39mm

123600

Saw Blade, Tungsten Carbide, width = 20mm, length = 39mm

123602

Saw Blade, Tungsten Carbide, width = 8mm, length = 39mm

123604



STITCH CUTTER AND SCISSORS

Stitch Cutter

- individually foil packed (sterile)
- 100/box

124000

SPENCER, 9cm

124009

SPENCER, 12.5cm

124011

LITTAUER, 14cm

124014

Stitch Scissor with clamp, 13cm

- cuts and removes suture in one step

124213



Bird Ring Cutter, Forceps

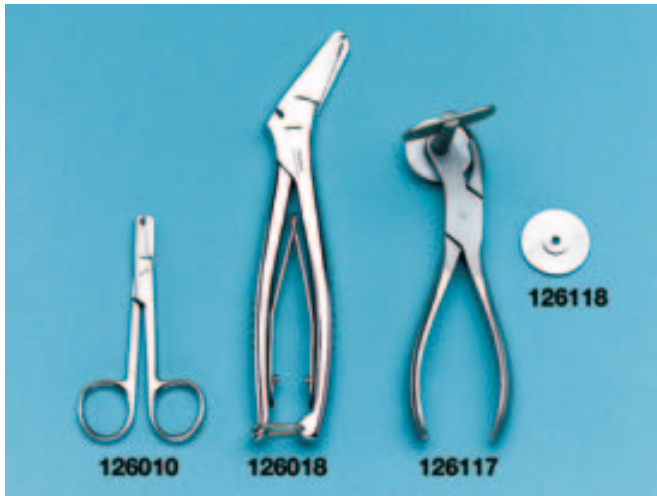

BIRD RING CUTTER

Easy and safe removal of bird rings

Bird Ring Cutter, 10cm

126010

Parrot Ring Cutter, 18cm

126018

Parrot Ring Saw, 17cm, stainless steel with exchangeable Saw Blade

126117

Spare Saw Blade for Parrot Ring Saw

126118



ATRAUMATIC FORCEPS

- firm grip
- protects delicate tissue
- Tungsten Carbide inserts

ADSON, 12cm, TC

130012

14.5cm, delicate, TC

130214

STANDARD, 14.5cm, TC

130314

16cm, 2mm, DE BAKEY toothed

130516



DISSECTING FORCEPS

ADSON, 12cm

132012

CUSHING, 18cm

132118

10cm, medium

132210

13cm, medium

132213

14.5cm, medium

132214

STANDARD, 13cm

132413

STANDARD, 14.5cm

132414

STANDARD, 16cm

132416

14cm, delicate, ECONOMY

971814

11.5cm, ECONOMY

972011

14cm, ECONOMY

972014

16cm, ECONOMY

972016

18cm, ECONOMY

not illustrated

972018

TISSUE FORCEPS

BONNEY, 18cm, 1x2 teeth, heavy model,
for thorax and soft tissue surgery
132618
OEHLER, 14cm, 1x2 teeth, TC
132714
ADSON, 12cm, 1x2 teeth
132812
ADSON, 15cm, 1x2 teeth
132815



TISSUE FORCEPS

ADSON-BROWN, 12cm, with lateral teeth,
- perfect for surgery and suture
132912
ADSON-BROWN, 15cm, with lateral teeth
132915
BROWN, 15cm, with lateral teeth
133015
SEMKEN, 12.5cm, 1x2 teeth, dedicate
133112



TISSUE FORCEPS

13cm, 1x2 teeth
133213
14.5cm, 1x2 teeth
133214
16cm, 1x2 teeth
133216
20cm, 1x2 teeth
133220
15cm, 1x2 teeth, heavy model
133315
14.5cm, 2x3 teeth, heavy model
133414
16cm, 2x3 teeth, heavy model
133416
DUVAL, 14cm
- with Tungsten Carbide inserts
133614
FEILCHENFELD, 9cm
134009
FEILCHENFELD, 11cm
134011
14cm, 1x2 teeth, ECONOMY
972114
16cm, 1x2 teeth, ECONOMY
972116
16cm, 2x3 teeth, ECONOMY
981346



VET Eickemeyer®

Your reliable source for
innovative products

Forceps, Towel Clips, Artery Clips



SPONGE AND DRESSING FORCEPS

GROSS, 20cm, straight, with ratchet
137020

MAIER, 26cm, straight, with ratchet
137426

MAIER, 26cm, curved, with ratchet
137526



TOWEL CLIPS

- extra sharp tips
- proper retention of surgical drapes

JONES, 5.5cm
140005

JONES, 9cm
140109

SCHAEFFEL, 9cm
140209

BACKHAUS, 9cm
140309

BACKHAUS, 11cm
140311

BACKHAUS, 13cm
140313

JONES, 9cm, ECONOMY
973109

SCHAEFFEL, 9cm, ECONOMY
973209

BACKHAUS, 9cm, ECONOMY
973309

BACKHAUS, 11cm, ECONOMY
973311

BACKHAUS, 13cm, ECONOMY
973313

VET Eickemeyer®

Visit us on our website
www.eickemeyer.de



ARTERY CLIPS

3.5cm, straight, DIEFFENBACH
140403

3.5cm, curved, DIEFFENBACH
140503

DELICATE ARTERY FORCEPS

- precise closure jaw
- smooth closing handle

BABY-MOSQUITO, 9cm, straight
141009

BABY-MOSQUITO, 9cm, curved
141109

HALSTED-MOSQUITO, 12.5cm, straight
141212

HALSTED-MOSQUITO, 12.5cm, curved
141312

HALSTED-MOSQUITO, 12.5cm, straight,
1x2 teeth
141412

HALSTED-MOSQUITO, 12.5cm, curved,
1x2 teeth
141512

MOSQUITO, 12cm, straight, ECONOMY
973412

MOSQUITO, 12cm, curved, ECONOMY
973512

MOSQUITO, 12cm, straight, 1x2 teeth,
ECONOMY
973612

MOSQUITO, 12cm, curved, 1x2 teeth,
ECONOMY
973712

ARTERY FORCEPS

CRILE, 14cm, straight
141614

CRILE, 16cm, straight
141616

CRILE, 14cm, curved
141714

PEAN, 14cm, straight
141814

PEAN, 14cm, curved
141914

PEAN, straight, 14cm, short jaw
142014

CRILE, 14cm, curved, ECONOMY
973714

PEAN, 14cm, straight, ECONOMY
973814

PEAN, 14cm, curved, ECONOMY
973914



Visit our Online-Shop
www.eickemeyer.de



Quality products
for the veterinary profession
since 1961

Forceps



142216

ARTERY FORCEPS ROCHESTER-PEAN

16cm, straight

142216

18cm, straight

142218

20cm, straight

142220

16cm, curved

142316

18cm, curved

142318

20cm, curved

142320

16cm, straight, ECONOMY

973816

18cm, straight, ECONOMY

973818

16cm, curved, ECONOMY

973916

18cm, curved, ECONOMY

973918

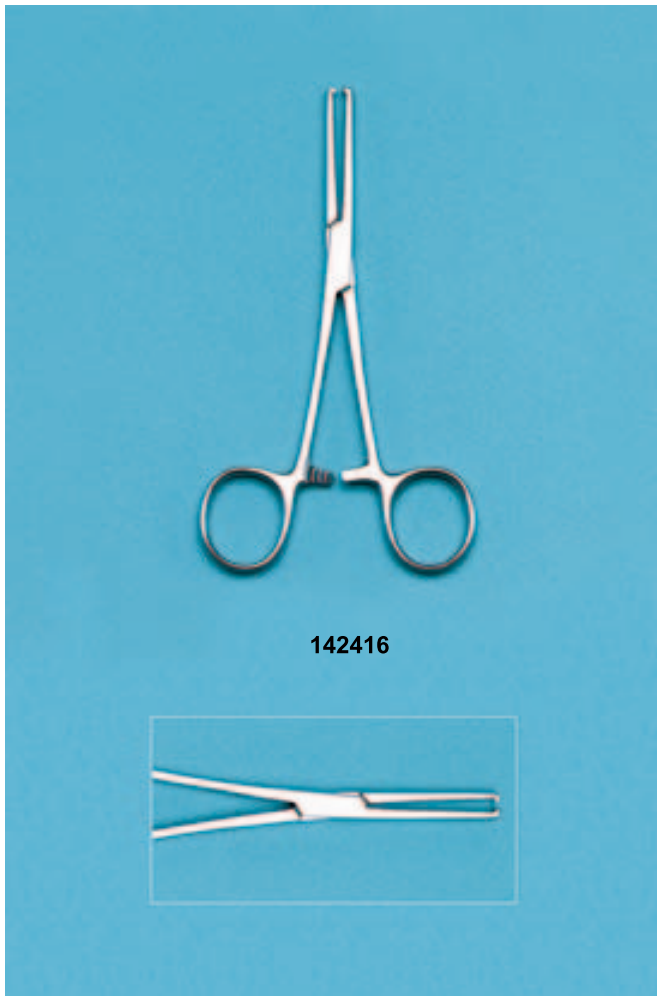

142416

ARTERY FORCEPS WITH TOOTHED KOCHER-OCHSNER

14cm, straight, 1x2 teeth

142414

16cm, straight, 1x2 teeth

142416

18cm, straight, 1x2 teeth

142418

20cm, straight, 1x2 teeth

142514

16cm, curved, 1x2 teeth

142516

18cm, curved, 1x2 teeth

142518

20cm, curved, 1x2 teeth

142520

14cm, straight, 1x2 teeth, ECONOMY

974014

16cm, straight, 1x2 teeth, ECONOMY

974016

18cm, straight, 1x2 teeth, ECONOMY

974018

14cm, curved, 1x2 teeth, ECONOMY

974114

16cm, curved, 1x2 teeth, ECONOMY

974116

18cm, curved, 1x2 teeth, ECONOMY

974118

SPECIAL PURPOSE ARTERY FORCEPS

- ideal for bitch spay

MIXTER, 17cm, curved

142717

SATINSKY, 15cm, curved, with atraumatic jaw

142915



ATRAUMATIC VASCULAR FORCEPS

- protects the tissue
- fast successful treatment
- special teeth for a safe grip
- atraumatic jaws

MOSQUITO, atraumatic, 12cm, straight

143412

MOSQUITO, atraumatic, 12cm, curved

143512



BOWEL CLAMPS

- very flexible
- perfect grip
- holds and seals the bowel with a minimum amount of pressure and trauma

BABY-KOCHER, 13cm, straight, lengthwise grip

144013

BABY-KOCHER, 13cm, curved, lengthwise grip

144113

DOYEN, 16.5cm, straight, cross grip

144216

DOYEN, 16.5cm, curved, cross grip

144316

MAYO-ROBIN, 21cm, straight, lengthwise grip

144621

MAYO-ROBIN, 21cm, curved, lengthwise grip

144721

DOYEN, 24cm, straight, lengthwise grip

144824

DOYEN, 24cm, curved, lengthwise grip

144924



Forceps



BOWEL AND TISSUE FORCEPS

- for easy tissue grip
- gentle teeth

ALLIS, 15cm, TC
145015

ALLIS, 15cm, 5x6 teeth
145315

ALLIS-THOMS, 20cm, 6x7 teeth
145320



TONGUE FORCEPS

YOUNG, 16.5cm
146116

Spare Rubber insert for Tongue Forceps
YOUNG, pair

146117

COLLIN, 16.5cm
146216



CHROMIC CATGUT

Natural collagen, twisted multifilament with a monofilament aspect, absorbable

EICKEMEYER CHROMIC CATGUT
4/0 CASSETTE 100 m
050720

EICKEMEYER CHROMIC CATGUT
3/0 CASSETTE 100 m
050725

EICKEMEYER CHROMIC CATGUT
2/0 CASSETTE 100 m
050723

EICKEMEYER CHROMIC CATGUT
0 CASSETTE 100 m
050720

EICKEMEYER CHROMIC CATGUT
1 CASSETTE 75 m
050721

EICKEMEYER CHROMIC CATGUT
2 CASSETTE 50 m
050722

EICKEMEYER CHROMIC CATGUT
3 CASSETTE 50 m
050724

EICKEMEYER CHROMIC CATGUT
4 CASSETTE 30 m
050726

VET Eickemeyer®

Your reliable source for
innovative products

E-AMID CASSETTE

Polyamide twisted and coated multifilament with a monofilament aspect, non-absorbable

E-AMID 4/0 CASSETTE 100 m
050707

E-AMID 3/0 CASSETTE 100 m
050706

E-AMID 2/0 CASSETTE 100 m
050705

E-AMID 0 CASSETTE 100 m
050700

E-AMID 1 CASSETTE 100 m
050701

E-AMID 2 CASSETTE 75 m
050702

E-AMID 3 CASSETTE 50 m
050703

E-AMID 4 CASSETTE 25 m
050704



Reverse cutting needles ▲	Size	Circular needles ●
150000	000	150300
150100	00	150400
150200	0	150500
150201	1	150501
150202	2	150502
150203	3	150503
150204	4	150504
150205	5	150505
150206	6	150506
150207	7	150507
150208	8	150508
150209	9	150509
150210	10	150510
150211	11	150511
150212	12	150512
150213	13	150513
150214	14	150514
150215	15	150515
150216	16	150516

- packs of 12 pcs

Reverse cutting needles ▲	Size
151100	0
151101	1
151102	2
151103	3
151104	4
151105	5

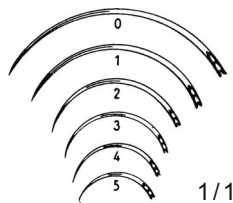

Eye needles 3/8 circle 1/1

Circular needles ●	Size	Reverse cutting needles ▲
150801	1	150701
150802	2	150702
150803	3	150703
150804	4	150704
150805	5	150705
150806	6	150706
150807	7	150707
150808	8	150708
150809	9	150709
150810	10	150710
150811	11	150711
150812	12	150712
150813	13	150713
150814	14	150714
150815	15	150715
150816	16	150716

Circular needles ●	Size
150900	00
151000	0
151001	1
151002	2
151003	3
151004	4
151005	5
151006	6
151007	7
151008	8

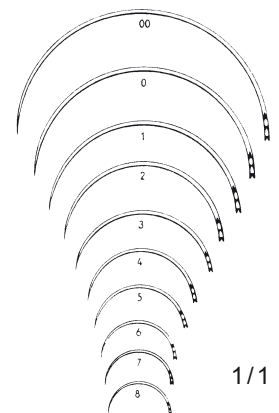

Suture needles 1/2 circle 1/1

EICKFIL

ABSORBABLE SURGICAL SUTURE



EICKFIL

Material: 100% Polyglycolic Acid – Braided & Coated.
Colour: Violet & undyed.
Coating: Calcium Stearate & Polycaprolactone.
Sterilization: Ethylene Oxide.
Shelf Life: 5 years

Features

- ▶ Absorbed by Hydrolysis, Absorption within 60–90 days
- ▶ Minimal tissue reaction.
- ▶ Coating ensures smooth tissue passage.
Outstanding pliability.

Packing

- ▶ Dry
- ▶ Primary packaging – Aluminium Foil.
- ▶ Secondary packaging:
Medical grade paper & Polyester laminated poly film.
- ▶ Packs of 12 pcs

Circular needles ●

Reverse cutting needles ▲

Art. No.	Needle	Metric	USP	Length/ in cm
050600	● 22mm	1.5	4/0	70
050601	● 22mm	2	3/0	70
050607	● 26mm	2	3/0	70
050615	● 30mm	2	3/0	70
050602	● 22mm	3	2/0	70
050608	● 26mm	3	2/0	70
050616	● 30mm	3	2/0	70
050622	● 37mm	3	2/0	70
050630	● 40mm	3	2/0	90
050637	● 48mm	3	2/0	90
050603	● 22mm	3.5	0	70
050609	● 26mm	3.5	0	70
050617	● 30mm	3.5	0	70
050623	● 37mm	3.5	0	70
050631	● 40mm	3.5	0	90
050638	● 48mm	3.5	0	90
050610	● 26mm	4	1	70
050618	● 30mm	4	1	70
050624	● 37mm	4	1	70
050632	● 40mm	4	1	90
050639	● 48mm	4	1	90
050644	● 60mm	4	1	70
050611	● 26mm	5	2	70
050625	● 37mm	5	2	70
050633	● 40mm	5	2	90
050640	● 48mm	5	2	90
050645	● 60mm	5	2	70
050650	▲ 19mm	1	5/0	70
050651	▲ 19mm	1.5	4/0	70
050658	▲ 24mm	1.5	4/0	70
050652	▲ 19mm	2	3/0	70
050659	▲ 24mm	2	3/0	70
050665	▲ 30mm	2	3/0	70
050653	▲ 19mm	3	2/0	70
050660	▲ 24mm	3	2/0	70
050666	▲ 30mm	3	2/0	70
050661	▲ 24mm	3.5	0	70
050667	▲ 30mm	3.5	0	70
050668	▲ 30mm	4	1	70

NEEDLE BOXES

- secure needle storage
- easy to handle
- careful sterilisation of the needles

With holes, 75×25×5mm

151501

W/o holes, 70×25×9mm

151502

W/o holes, 70×53×9mm

151503

Needle Case with interior case, circular, 65×17mm

151507

Interior Case with holes, for 151507, 62×15mm

151508

Needle Case with interior case, circular, 95×16mm

151509

NEEDLE BOX LARGE

With holes, 7 compartments, 150×95×13mm

151504

NEEDLE HOLDER MATHIEU, WITH TUNGSTEN CARBIDE INSERTS (TC)

- highest grade stainless steel
- long lasting inserts for secure grip
- smooth ratchet

MATHIEU, 14cm, TC

152114

MATHIEU, 17cm, TC

152117

EICKEMEYER-GRACILE, 17cm, with internal ratchet, TC

152317

MATHIEU, 20cm, TC

152120

MATHIEU, 21cm, heavy model, TC

- heavy duty model for the large animal practitioner

152121

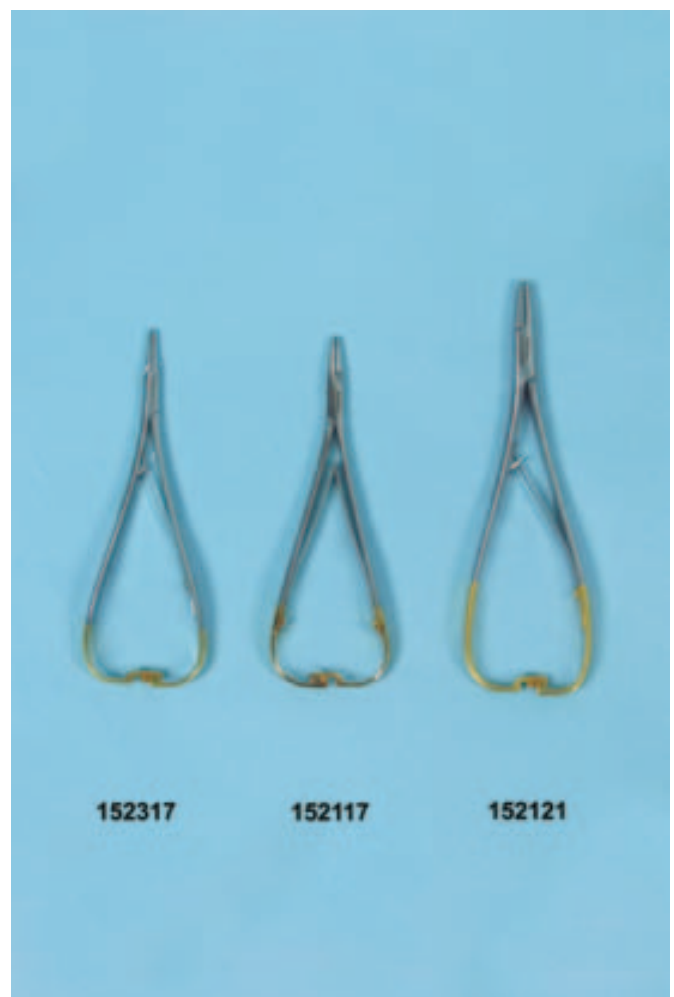
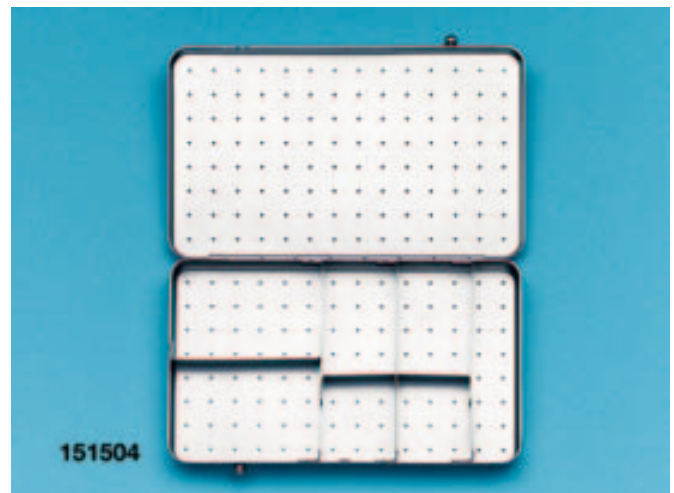
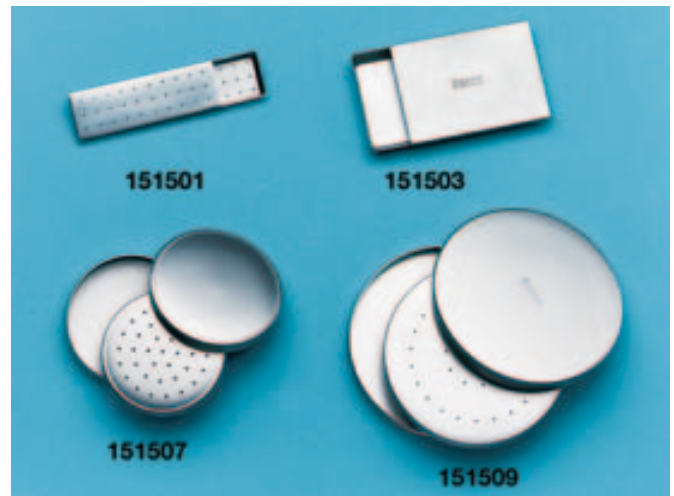

Needle Holders



NEEDLE HOLDER WITH TUNGSTEN CARBIDE INSERTS (TC)

- special Tungsten Carbide inserts provide firm grip
- extremely durable

MATHIEU-OLSEN, 14cm, TC
152414

MATHIEU-OLSEN, 17cm, TC
152417

MATHIEU-OLSEN, 19cm, TC
152419

MAYO-HEGAR, 15cm, TC
152515

MAYO-HEGAR, 18cm, TC
152518



NEEDLE HOLDER WITH SCISSOR HANDLE AND TUNGSTEN CARBIDE INSERTS (TC)

- special carbide inserts provides firm grip, no needle turning
- ergonomic handle
- long lasting
- with sharp cutting scissors

OLSEN-HEGAR MINI, 12cm, TC
152612

OLSEN-HEGAR, 14cm, TC
152614

OLSEN-HEGAR, 16cm, TC
152616

OLSEN-HEGAR, 18cm, TC
152618

GILLIES, 16cm, RH, with scissors
153016



STANDARD NEEDLE HOLDER

- smooth ratchet
- long lasting
- best price performance

MATHIEU, 14cm
153114

MATHIEU, 17cm
153117

MAYO-HEGAR, 15cm
153415

OLSEN-HEGAR, 14cm
153514

OLSEN-HEGAR, 16cm
153516

MATHIEU, 17cm, ECONOMY
975017

REPAIR OF NEEDLE HOLDERS WITH CARBIDE INSERTS (TC)

Send us your broken needle holders. Generally it is worth repairing them. We help you to save money.

VET Eickemeyer®

Our service – your benefit



We repair your needle holders

DESCHAMPS LIGATURE NEEDLE

- 45cm, right/sharp
- modified acc. to HUSKAMP
- long model for equine surgery
154045
- 45cm, left/sharp
154145
- 20cm, left/blunt
154320
- 20cm, right/blunt
154220
- 20cm, left/sharp
154120
- 20cm, right/sharp
154020
- 20cm, left/sharp, small curve
154520
- 20cm, right/sharp, small curve
154420



SUTURE CLIPS

- Stapler STICHS, 16mm, 500/pack
157016
- Stapler STICHS for 16mm Staples
157116



DISPOSABLE SKIN STAPLER

- faster recovery with minimal scar
- low infection risk
- individually sterile packed
- attractive price
- barely scar formation minimal scar

Disposable Skin Stapler with 35 stainless steel staples, staples size: 6.8mm×3.9mm
157310

- Skin Staple Extractor, stainless steel, sterilisable
- for easy removal of staples
157309



Probes, Retractors

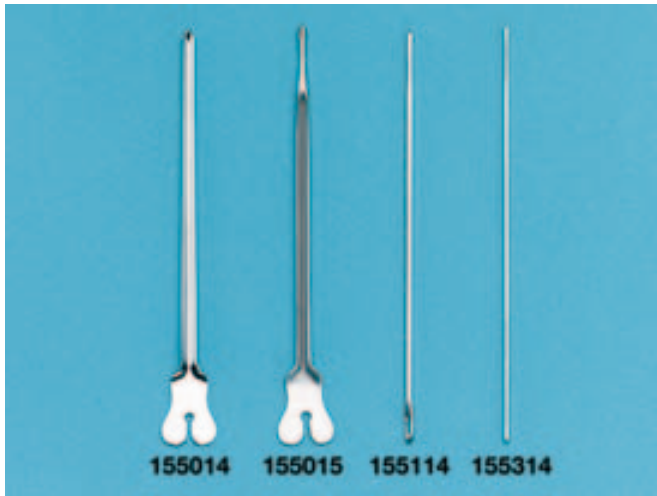

PROBES

Groove Director, 14.5cm

155014

Groove Director with Probe, 15cm

155015

Probe with eye, 14.5cm

155114

Button Probe, 1.5mm, 14.5cm

155314

Button Probe, 2mm, 14.5cm

155414



RETRACTORS

SENN-MILLER, 17cm, sharp point

160117

STRANDELL-STILLE, 19cm

160319

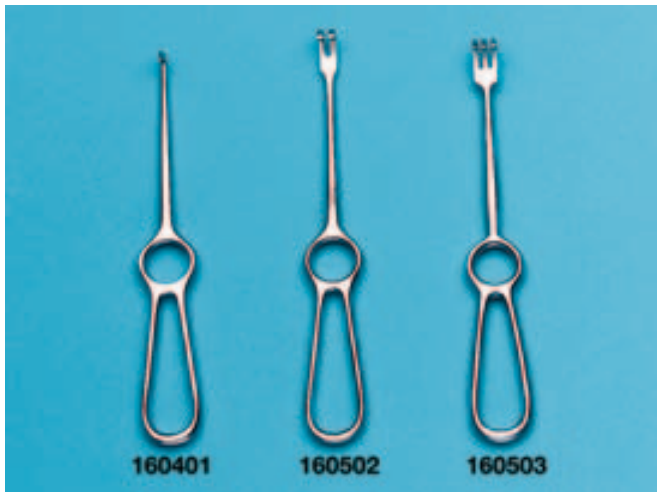

RETRACTORS

VOLKMANN, 20cm, 1 prong, sharp

160401

VOLKMANN, 22cm, 2 prongs, blunt, 9×8mm

160502

VOLKMANN, 22cm, 3 prongs, blunt, 9×13mm

160503

LANGENBECK, 21cm, 25×8mm

not illustrated

160621



ROUX RETRACTORS

Set, size 1–3

160700

PARKER-LANGENBECK (ARMY-NAVY) RETRACTORS

21cm, double ended, set, size 1 & 2
160900



WEITLANER RETRACTORS

10.5cm, sharp

161310

13cm, sharp

161313

20cm, sharp

161320

10.5cm, blunt

161410

13cm, blunt

161413

16.5cm, blunt

161416

20cm, blunt

161420



GELPI RETRACTOR

- sharp tips
- extremely versatile retractor
- particularly useful in orthopaedic surgery

9cm

161609

11cm

161611

14cm

161614

19cm

161619



COLLIN LARYNX RETRACTOR

20cm, with narrow blades

161720

Roaring burr, 21cm

161821



Self Retaining Retractors

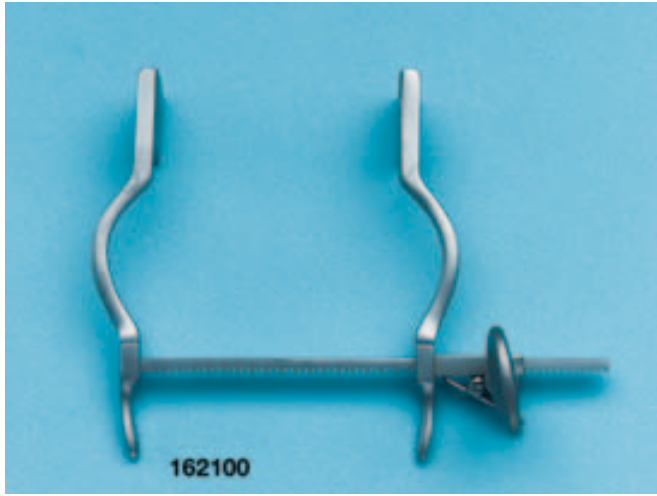

HERTZLER ABDOMINAL RETRACTOR

- Measurements:
- Length = 150mm
 - Height = 25mm
 - Width = 25mm
 - Spreadable up to 120mm

162100



BABY-BALFOUR ABDOMINAL RETRACTOR

- Measurements:
- Length = 120mm
 - Height = 27mm
 - Width = 27mm
 - Spreadable up to 90mm

162110



GOSSET ABDOMINAL RETRACTOR

- Measurements:
- Length = 200mm
 - Height = 35mm
 - Width = 63mm
 - Spreadable up to 160mm

162120



BALFOUR ABDOMINAL RETRACTOR

- Measurements:
- Length = 250mm
 - Height = 35mm
 - Width = 70mm
 - Spreadable up to 180mm

162130

Self Retaining Rib Spreaders, Tenaculum Forceps, Bone Scoops

FINOCCHIETTO-BABY RIB SPREADER

Measurements:

- Length = 115mm
- Height = 20mm
- Width = 20mm
- Spreadable up to 75mm

163000

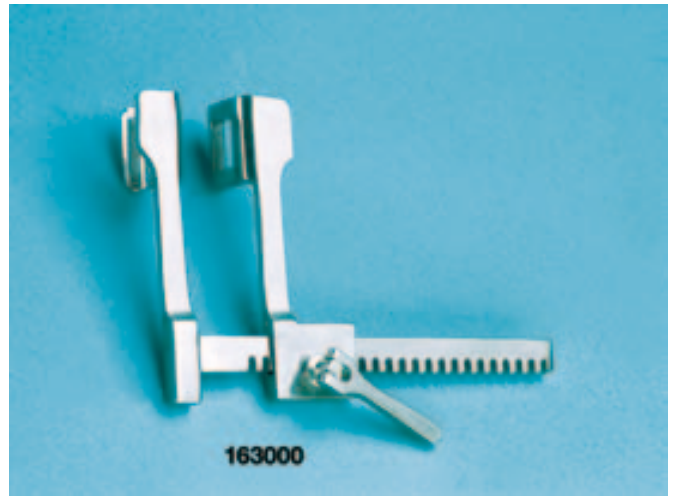

RIB SPREADER

HAIGHT

Measurements:

- Length = 195mm
- Height = 30mm
- Width = 30mm
- Spreadable up to 90mm

163001

FINOCCHIETTO

Measurements:

- Length = 210mm
- Height = 40mm
- Width = 40mm
- Spreadable up to 165mm

163002

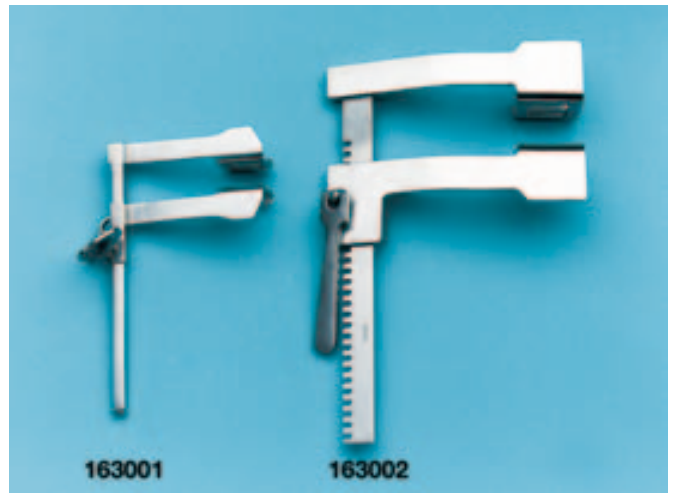

TENACULUM AND GRASPING FORCEPS

Tenaculum forceps PRATT, 27cm width of jaw
22mm

164127

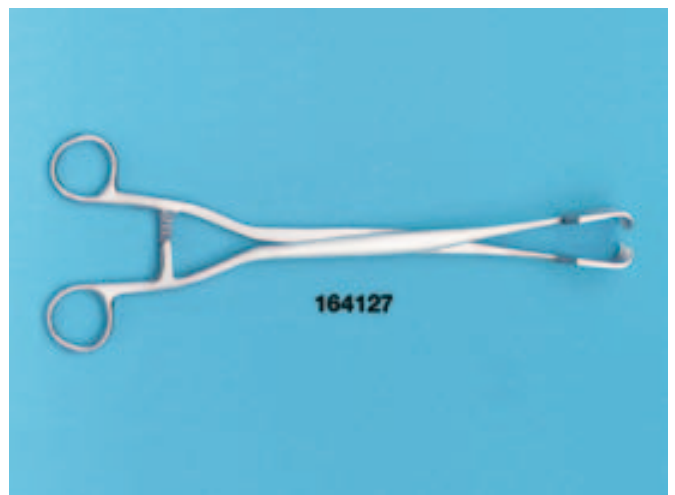

VOLKMANN BONE SCOOPS

- oval cutting surface, single ended scoop
- excellent cutting accuracy, very sharp

Size 000, width = 4mm

165000

Size 00, width = 5mm

165100

Size 0, width = 6mm

165200

Size 1, width = 7mm

165201

Size 2, width = 8mm

165202

Size 3, width = 9mm

165203

Size 4, width = 11mm

not illustrated

165204



Bone Scoops, Periosteal Elevators, Ophthalmoscopes



BONE SCOOPS

Bone Scoop, 17cm, very delicate and deep, black chrome

165317

MARTINI, 14cm, double ended

165514

WILLIGER, 14cm, double ended

165614

VOLKMANN, 14cm, double ended

165714

VOLKMANN, 17cm, double ended

165717



PERIOSTEAL ELEVATORS

To remove tissue from bones

WILLIGER, 14cm, 4mm

166014

WILLIGER, 16cm, 6.5mm

166016

Handle "Ferrozell" 18.5cm, 3mm, sharp

166018

Handle "Ferrozell" 18cm, 6mm, sharp

166118

Handle "Ferrozell" 19.5cm, 14mm, sharp

166219



WELCH ALLYN PANOPTIK

Revolutionary concept for visualising the fundus

- illumination system converges the light to a point at the cornea, allowing
- easy entry into small, undilated pupils
- the illumination pathway then diverges to the retina, illuminating a very
- wide area of the fundus
- provides a 5-times larger view of the fundus than with a standard
- ophthalmoscope in an undilated eye
- enables a 25-degree field-of-view
- greater working distance improves the comfort of both examiner and patient
- the dynamic focusing wheel adjusts the focus in a continuous, smooth action
- for more precise control
- focusing range of -20 to +20 diopters

WELCH ALLYN PANOPTIK w/o Battery Handle

301145

Adaptor WELCH-ALLYN to HEINE Battery Handle

302046

WELCH ALLYN Battery Handle for PanOptik and Video Oscope

302045

HEINE OMEGA 500 BINOCULAR INDIRECT OPHTHALMOSCOPE

Based on the market leading Omega 180 the Omega 500 has been optimised for even clearer views of the fundus. A new multicoated illumination system incorporating Xenon Halogen technology, minimises reflex off the cornea and produces high resolution images

- super light weight
- only 450g

173480

HEINE OMEGA 500 unplugged with headband battery

100% freedom of movement

- no cable connections!

The OMEGA 500 ophthalmoscope with mPack UNPLUGGED rechargeable battery allows one-of-a-kind mobility without restriction or hindrance caused by cables, cords, or similar connections. In addition, the OMEGA 500 with mPack UNPLUGGED is the lightest indirect ophthalmoscope of its kind on the market! Direct operation possible while charging through the use of the mobile plug-in transformer. LED charge status indicator. LED indication of remaining operating time. Lightweight with balanced weight distribution. High level of comfort. Charging time 2 hours.

173485



173480



173485

V E T Eickemeyer®

Visit us on our website

www.eickemeyer.de

Accessories for HEINE OMEGA 500, Aspheric Lenses



ACCESSORIES FOR HEINE OMEGA 500

Aspheric ophthalmoscope lens 20 D = 50mm,
with case

173470

Aspheric ophthalmoscope lens 30 D = 46mm,
with case

173471

Teaching mirror for OMEGA 500

173465

Carrying case for head mounted
ophthalmoscope OMEGA 500

- to prevent damage during transportation
- durable

173490

Battery power pack with brightness control and
charger, for OMEGA 500

- lasts appx. 1 hour (continuous use)

173475

mPack with Li-ion rechargeable battery and
transformer.

The new mPack offers freedom from cables,
the Li-ion technology gives triple the capacity of
current Ni-cad systems and more than double
that of existing Li-ion systems.

173476



VOLK DOUBLE ASPHERIC LENSES

VOLK 15D

17353815

VOLK 60D

17353860

VOLK 78D

17353878

VOLK 90D

17353890

VOLK Pan Retinal 2.2 D

173536



KOWA GENESIS-D HANDHELD DIGITAL RETINAL CAMERA

Small, lightweight, single handed operation for professional documentation

- high resolution (2 megapixel)
- high resolution 2.5" LCD
- recording media: Compact Flash or via USB
- lightweight (only 1070g)
- with diopter adjustment
- Xenon flash-light

173530

Footswitch for GENESIS-D

173531

Tonometer



173560

REICHERT TONO-PEN VET

Applanation Tonometer for the measurement of intraocular pressure

- ideal instrument to screen intraocular pressure
- the easiest way to detect glaucoma
- the patient can be positioned in any way
- fast and accurate IOP measurement with minimal training
- large and easy-to-read display
- less cornea irritation due to smaller sensor
- disposable covers to eliminate cross contamination
- range of measurements: 5–80mm Hg
- lightweight (only 64 g)
- maintenance free
- including OCU-Film tip covers, 150/box

173560

OCU-FILM Tip Covers, 150/box

173565

TONOMETER AVIA

Combines all benefits of the TONOPEN Vet plus:

- ergonomic design
- long lasting battery (more than 2500 measurements)
- no daily calibration
- large display on both sides
- ideal for the ophthalmic specialist

173600



SCHIOETZ TONOMETER

- original improved model with 2 weights
- for intraocular pressure screening
- contains full instructions for use

173551



TEAR TEST

SCHIRMER Tear Test, 100 stripes/box

- physiological area: 10–20mm
- suspicious area: < 10mm
- profoundly path. altered: < 5mm(“dry eye“)

173590

FLUORESCEIN Test, 10 blocks with 100 stripes/block

- slight dyeing of the cornea

173595

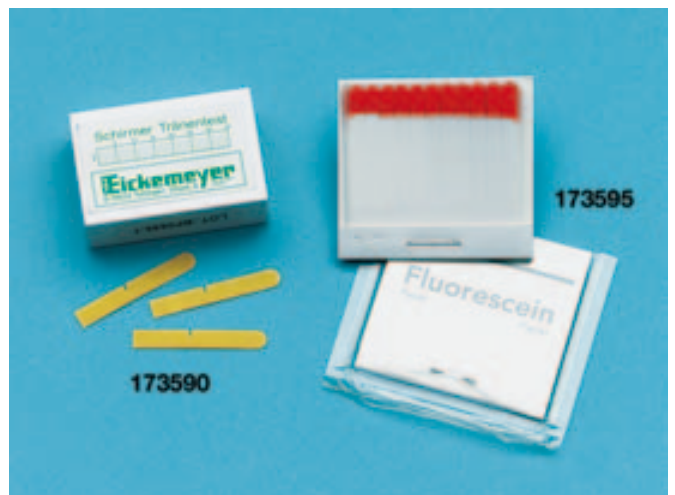

GONIOSCOPY LENSES

- examination of the eye
- easy to handle
- specially designed for small animals

KOEPPE, 17mm

173574

KOEPPE, 18mm

173575

BARKAN

- hydrostatic pressure attaches lens to cornea

173580

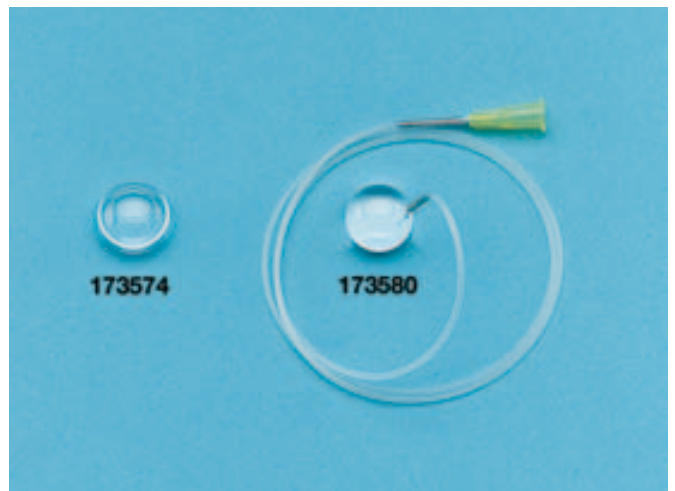



173585



EICKEMEYER ERG-SYSTEM

- hereditary and acquired disorders of the retina can be evaluated
- useful in determining if retinal surgery is recommended
- complete ERG and VEP testing
- provides accurate data
- easy to use
- connectable to any PC or Notebook (Win98 or higher)
- incl. white stimulus, 9 disposable lens electrodes and one needle electrode

ERG/VEP System

173585

Needle electrode 12mm 0.28 GA

173586

Disposable lens electrode, 3/box

173587

SURGICAL MICROSCOPE

A new dimension in micro and eye surgery

- ergonomic construction gives a you relaxed comfortable position even when operating for long periods
- 5 magnifying steps:
3.6x/ 5.4x/ 8.9x/ 14.2x/ 22.3x
- Visual field = 56–9mm
- integrated light source, 150 W, delivers bright light
- Micro-focusing 40mm, motorised, pedal operated
- mobile floor stand with 5 lockable castors provides excellent mobility
- available with wall mounting on request

Operating microscope with Electronic Zoom
328140



MAGNIFYING LOUPE

VETERINARY STEREO Magnifying Loupe

- 2.2x magnification
- working distance: 200mm
- lightweight
- can be worn over regular glasses

310602

ESCHENBACH Binocular Loupe

Mounted Galilean systems for near vision

- 4x magnification
- visual field: 35mm / 250mm
- working distance: 250mm

310704



Magnifying Glasses: Glasses, Binocular Loupes



MAGNIFYING GLASSES MAX DETAIL

The economic glasses for demanding detailed work

- Magnification: 2.0 x
- very simple to use due to large PD tolerance range
- large distance of use = approx. 40cm
- weight = only 40g
- also suitable for spectacle wearers as they have right and left dioptre compensation which can be separately adjusted

310600

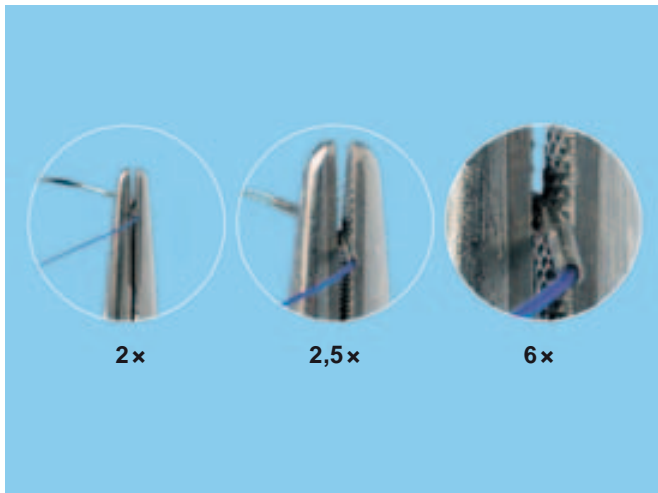

A GUIDE TO MAGNIFICATION SELECTION

Simply select the lowest magnification that will meet your needs. The lower the magnification, the larger the field of view, and the easier the loupe will be to use. Then determine your working distance, which will also automatically determine your field of view. To determine your working distance, assume a comfortable, posture-correct position for the intended loupe application and determine the distance between your eyes and your working area. Using the chart below, match this distance with the nearest nominal working distance option shown beside the magnification you chose.

Note: The closer the loupes are O3. Finally, select your preferred mounting option, Spectacle Frame or Headband. All options offer the user flexibility and adaptability for precise optical position, alignment and performance.



HEINE HR S-FRAME BINOCULAR LOUPE

- 2.5x magnification, working distance 420mm
- Maximum comfort thanks to modern, ergonomic design
- State-of-the art technologies and innovative materials
- Low weight (only 42g)

310707

HEINE LED Loupelight

- powered by 3.5V HEINE battery or rechargeable handle. Fully portable.

310708

MAGNIFYING GLASSES HEINE HR

like 310707, but with lightweight headband
310710

like 310707, but with headband professional L
310713

4× magnification and 340mm working distance
 - with lightweight headband
not illustrated
310711

6× magnification and 340mm working distance
 - with lightweight headband
not illustrated
310712

4× magnification and 340mm working distance
 - with headband Professional L
310714

6× magnification and 340mm working distance
 - with headband Professional L
not illustrated
310715

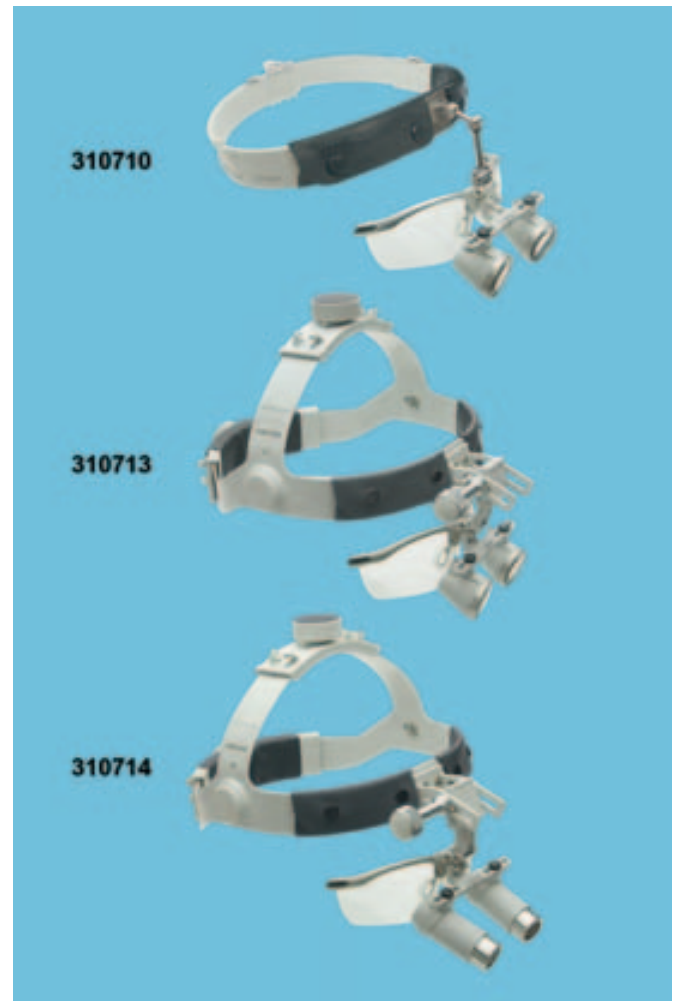

WELCH ALLYN HEADLIGHT

- cool, bright light for excellent evaluation of tissue colour and structure
- focusable light field of appx. 10cm
- working distance: 30cm
- positioning individually adjustable
- soft headband with Velcro closure
- rechargeable lithium-battery incl. net plug, integrated in the headband
- longlasting lamp

With white headband

311100

External battery power pack. Up to 4 hrs. of continuous illumination
311101



FIBRE OPTIC HEADLIGHT

- fits to universal fibre light cable 306518/20/30 (see page 167)
 - with comfortable headband
 - please inform us about your light source
- 311120**



Headlamp, Headlight



HEINE 3S LED HEADLIGHT

- Reference colour temperature of 6.000 Kelvin and an extraordinary 30.000 Lux of illumination
- compact design ensures clear, unobstructed co-axial illumination
 - weight: only 70g
 - continuously adjustable spot size and brightness control
 - mains or portable power supply
 - integrated attachment options for HR/HRP Binocular Loupes and Prism for Video

311130

like 310707, but with lightweight headband

311132

Guard for 3S-LED Headlight

311131

Unplugged (no cables, headband integrated high capacity battery pack) with Headband Professional L

311133



HEADLIGHT EQUI-LITE

- portable Halogen Headlight System
- integrated bulb cooling
- heavy duty but lightweight aluminium body
- including power supply

177721



SUPERLIGHT HEADLIGHT

With LED-lighting technology

- ultra lightweight, only 70g (incl. batteries)
- bright, white light for optimal illumination of the treatment area
- LED's last for several years of continuous use

178201

EYELID SPECULAE AND RETRACTORS

Eyelid Speculum BARRAQUER (COLIBRI),
4cm

170004

Eyelid Speculum GRAEFE, 9cm

170009

Eyelid Speculum CASTROVIEJO, 8cm

170008

Eyelid Retractor DESMARRES, 14mm, size 2

170114

Eyelid Retractor DESMARRES, 16mm, size 3

170116

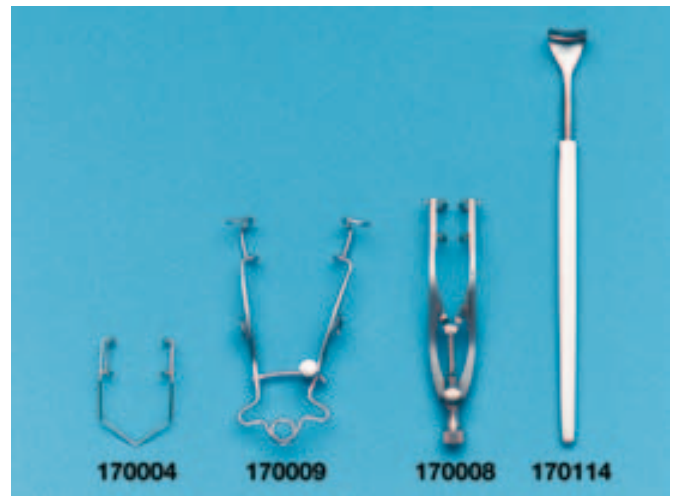

DEPILATION FORCEPS

DOUGLAS, 9cm

170309

GRADLE, 9.5cm

- extra firm grip

170310



TEAR DUCT INSTRUMENTS

BOWMAN Probe, size 0/00, German silver,
pointed

170470

WILDER Dilator, size 1

170481

WILDER Dilator, size 2

170482

WILDER Dilator, size 3

170483

KELLNAR Probe, left

170486

KELLNAR Probe, right

170487

KELLNAR Probe, double

170490

Silicon Tube for KELLNAR Probes,
ID = 0.3mm, OD = 0.6mm, length = 1m

170503

Silicon Tube for KELLNAR Probes,
ID = 0.5mm, OD = 0.9mm, length = 1m

170505

Silicon Tube for KELLNAR Probes,
ID = 0.7mm, OD = 1.6mm, length = 1m

170507

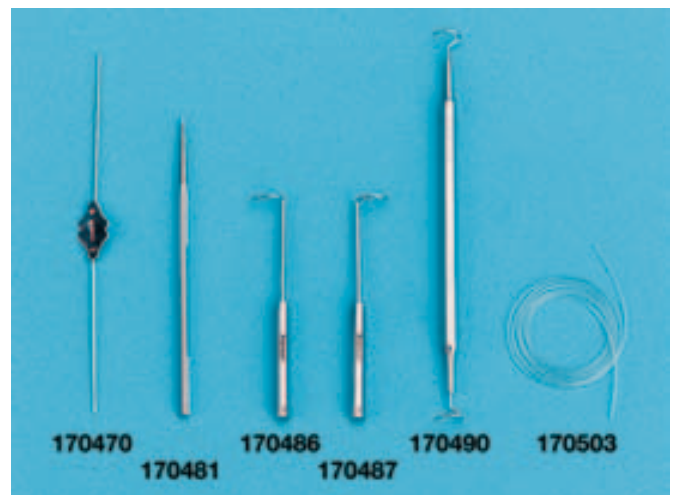

Eye Surgery Kit, Ophthalmic Instruments



OPHTHALMIC INSTRUMENTS

Cornea Scraper KUHNT

170331

Scoop MEYHOEFER, 2mm, sharp

170420

Scoop MEYHOEFER, 2.5mm, sharp

170512

Cyclodialysis Spatula CASTROVIEJO, double

170512

Eye Hook GRAEFE, blunt

170440

Lens Loop WEBER

170464



EYE SURGERY KIT

complete with autoclavable silicone pegged mat and autoclave container

- Scalpell handle No.3
- ADSON forceps 12 cm
- eye lid retractor BARRAQUER (Colibri)
- cornea scraper KUHNT
- lens loup WEBER
- cyclodialysis spatula CASTROVIEJO, double
- Iris forceps HESS (Colibri), 7 cm
- Iris forceps BISHOP-HARMON, 8.5 cm, 1x2 teeth, 0.5mm
- Capsular forceps FUCHS
- fixation forceps GRAEFE, 11 cm, with splint
- suture forceps CASTROVIEJO, teeth 0.5 mm, 10 cm
- suture forceps TUEBINGEN, 10 cm
- Chalazian forceps DESMARRES, 9 cm
- iris scissor CASTROVIEJO, curved, 10 cm, sharp
- cornea scissor CASTROVIEJO, 10 cm, left
- Chalazion Forceps DESMARRES, 9cm
- Iris Scissor CASTROVIEJO, 10cm, curved, sharp
- Cornea Scissor CASTROVIEJO, 10cm left
- Cornea Scissor CASTROVIEJO, 10cm right
- Needle Holder BARRAQUER, 11cm, curved, round handle, w/o ratchet
- Tenotomy Scissors STEVENS, 11cm, curved, blunt/blunt

173020



EYE FORCEPS

Chalazion Forceps DESMARRES, 9cm, fig. 2

171522

Nictitating Membrane Forceps STADES, 9.5cm

171609

Trachom/roll Forceps KNAPP, 11cm

171611

GRAEFE FIXATION FORCEPS

11cm, with splint
171411
 11cm, with lock
171412



CAPSULE AND SUTURE FORCEPS

Capsule Forceps HESS, 6.5cm, double curved
171306
 Capsule Forceps GILL-ARRUGA, 7.5cm
171307
 Suture Forceps CASTROVIEJO, 10cm,
 teeth = 0.3mm
171503
 Suture Forceps CASTROVIEJO, 10cm,
 teeth = 0.5mm
171505
 Suture Forceps TUEBINGEN, 10cm
171510



CAPSULE FORCEPS ARRUGA

length 10cm
 - specially designed for intraocular surgery
171309



EYE FORCEPS UTRATA TITANIUM

10cm
 Specially designed for intraocular surgery
171511



Ophthalmic Instruments

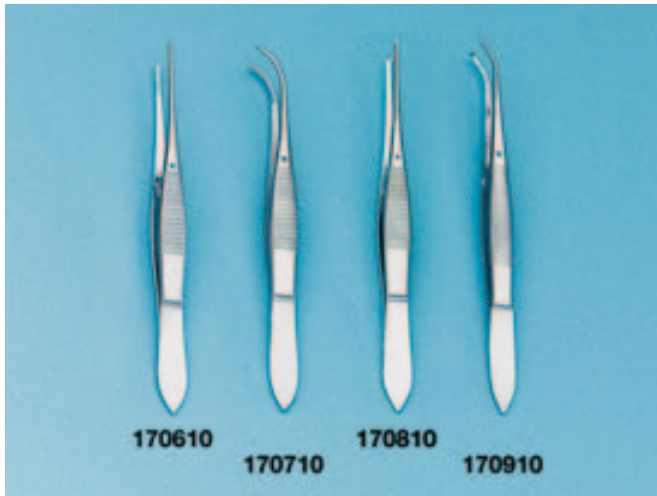

GRAEFE IRIS FORCEPS

10cm, straight, serrated

170610

10cm, curved, serrated

170710

10cm, straight, 1x2 teeth

170810

10cm, curved, 1x2 teeth

170910

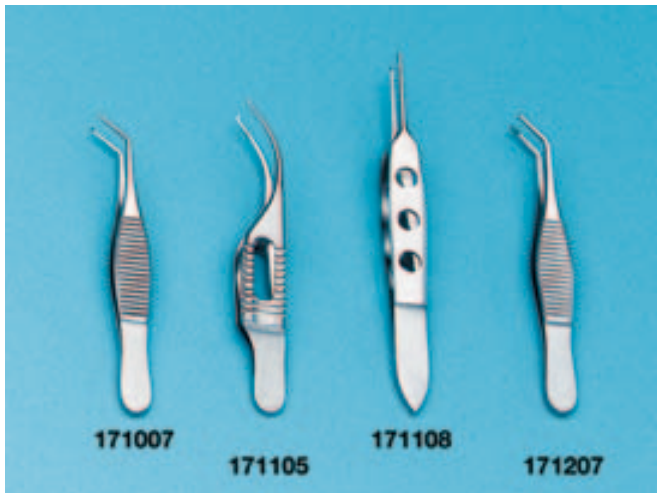

IRIS AND CAPSULE FORCEPS

Iris Forceps HESS/Colibri, 7cm

171007

Iris/Suture Forceps BARRAQUER, 7cm, teeth:
0.5mm / 45°

171105

Iris/Suture Forceps BARRAQUER-KATZIN
(Colibri), 7cm, teeth: 0.12mm / 90°

171107

Iris Forceps BISHOP-HARMON, 8.5cm, 1x2
teeth

171108

Capsule Forceps FUCHS, 7cm

171207

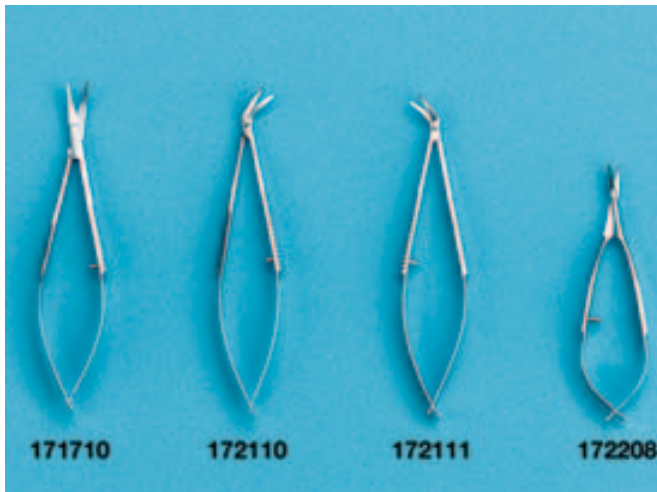

IRIS AND CORNEAL SCISSORS

Iris Scissors CASTROVIEJO, 10cm, curved,
sharp

171710

Corneal Scissors CASTROVIEJO, 10cm, left,
curved

172110

Corneal Scissors CASTROVIEJO, 10cm, right,
curved

172111

Secondary Cataract Scissors VANNAS, model
TUEBINGEN, 8.5cm, sharp, curved

172208

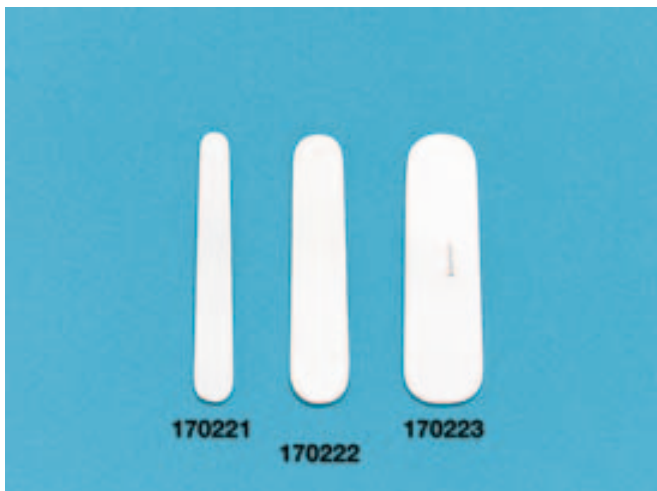

EYELID SPATULAS GRAENITZ

- to put under the eye lid while cutting

- length: 77mm

Size 1, width: 10mm

170221

Size 2, width: 16mm

170222

Size 3, width: 22mm

170223

Size 4, width: 25mm

not illustrated

170224

EYE NEEDLE HOLDERS

CASTROVIEJO, 14cm, straight, with ratchet
172414

CASTROVIEJO, 14cm, curved, with ratchet
172514

BARRAQUER-TROUTMANN, 10cm, curved,
round handle, with ratchet
173010

BARRAQUER, 11cm, curved, round handle,
w/o ratchet

- perfect for intraocular surgery
173011

BOYNTON, 12cm, straight, TC
- perfect for lid surgery
173112

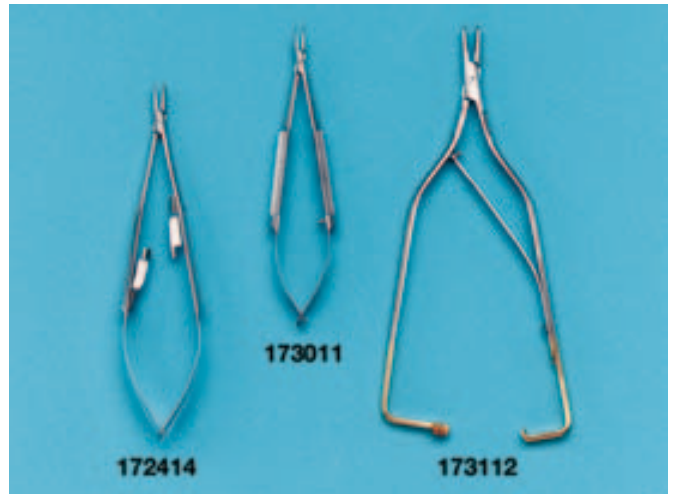

EYE IMPLANTS

- black silicon
- for cosmetic treatment after bulbus extraction

Eye Implant Inserter
173500

Diameter = 14mm
173514

Diameter = 15mm
173515

Diameter = 16mm
173516

Diameter = 17mm
173517

Diameter = 18mm
173518

Diameter = 19mm
173519

Diameter = 20mm
173520

Diameter = 22mm
173522

Diameter = 23mm
173523

Diameter = 24mm
173524

Diameter = 26mm
173526

Diameter = 28mm
173528

Diameter = 30mm
1735290030

Diameter = 33mm
1735290033

Diameter = 36mm
1735290036

Diameter = 38mm
1735290038

Diameter = 40mm
1735290040

Diameter = 45mm
1735290045

Diameter = 43mm
1735290043

Diameter = 50mm
1735290050

Diameter = 47mm
1735290047

Diameter = 52mm
1735290052

Diameter = 55mm
1735290055

Diameter = 60mm
1735290060

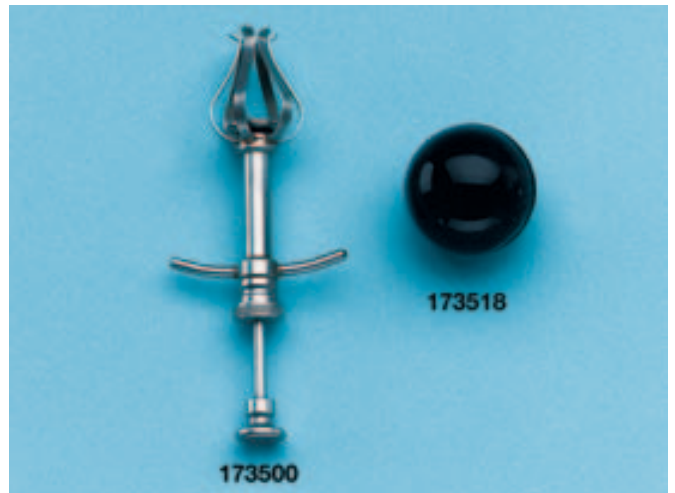

Cellulose Spears, Cryosurgery

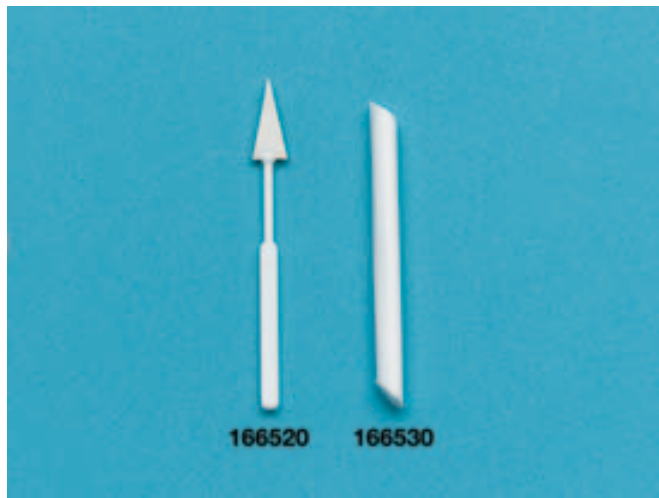

CELLULOSE SPEARS

- extremely absorbent

Cellulose Spears, wedge-shaped, 200/box
166520

Cellulose Spears, round, length 66mm,
diam. 5mm, pointed tips, 500/box
166530



KRYOSURGERY "CRYO-STICK"

The Cryostick is an evolutionary lightweight multifunctional instrument made up of a cartridge and a body.

- extremely precise, with a constant penetrating temperature of -89°C during work
- rare scares
- ideal for ophthalmic and dermatologic procedures
- special cartridge prevents loss of N_2O

Including 1 cartridge

173443

N_2O Cartridge

173444

State of the art continuing education centre in Tuttlingen, Germany



Since 1985 almost 10.000 veterinary professionals from all over the world have attended our courses.



Theory lectures, practical demonstrations and hands-on veterinary seminars in full operating theatre facilities provide the maximum learning in the minimum time.

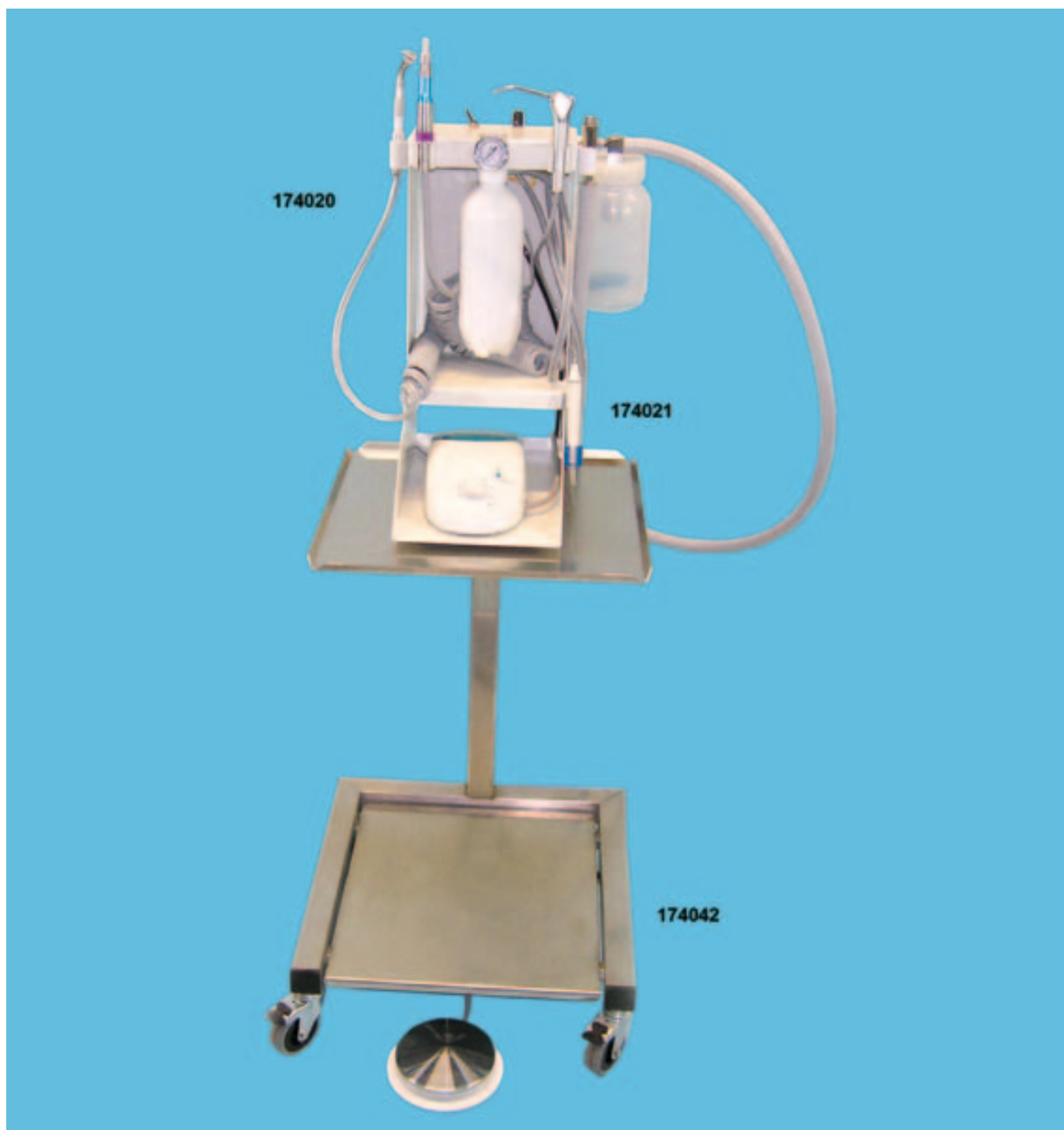

DENTAL CARE UNIT EICKEMEYER PROFIDENT PLUS

Compact unit for professional animal dental care

- high-speed handpiece (water-cooled) up to 400.000 rpm
- straight low-speed handpiece up to 20.000 rpm
- water flow control
- 3-way air/water syringe
- attachment for prophy cups
- integral suction unit with tank
- easy to fill water tank
- foot switch
- unit will be delivered ready for use – just connect a compressor
- table top or wall mountable
- stand not included

Dental Care Unit PROFIDENT Plus

174020

Scaling Extension to 174020 including EICKSONIC Ultrasonic Scaler

174021

Complete stainless steel stand with 4 lockable casters

174042

Disposable Suction Tube, 3 pcs./pack.

174048

Handpieces, Compressor



CONTRA ANGLE HANDPIECES

High-speed Handpiece, friction grip (FG), with key, water cooled, up to 400.000 rpm

- good quality
- reasonable price

174055

Low-speed Handpiece, to use with SCHEIN/PROFIDENT Units, fits burs and polisher with contra angled shaft

not illustrated

174061



STRAIGHT HANDPIECES

Straight Handpiece incl. Low-speed Air Motor, max 20.000 rpm

- used e.g. to cut rabbit teeth
- best price performance

174060

Single Straight Handpiece for use with Snap On Propy Head (174063) and Propy Cups (174014)

not illustrated

17406001



SNAP-ON PROPHY HEAD

Fits on Low-speed Handpieces 174060 and 17406001, for Propy Cups 174065

174063

Disposable, Snap-On Propy Cups for Propy Head (174063), 36/box

174065



COMPRESSOR FOR DENTAL CARE UNITS

340 Watt, 230V, 8 bar, 50L/Min

- silent operation
- compact
- low maintenance
- powerful
- to use with PROFIDENT Plus (174020)

174052

Air Filter

- reduces oil emission to almost 0%
- to extend the life of your handpieces

174043

DENTAL MICROMOTOR EICKEMEYER

- compact and powerful motor
- high-performance 0–35.000 rpm
- variable speed control
- clockwise and counter-clockwise rotation
- best value for money
- including foot switch

Micromotor EICKEMEYER incl. foot switch
174025

Handpiece, contra angle, autoclavable
174026

Handpiece, straight, autoclavable
174027



STARTER BUR KIT

Including burs for straight handpiece and burs with friction grip (FG) for previously high speed contra angle handpieces
174100

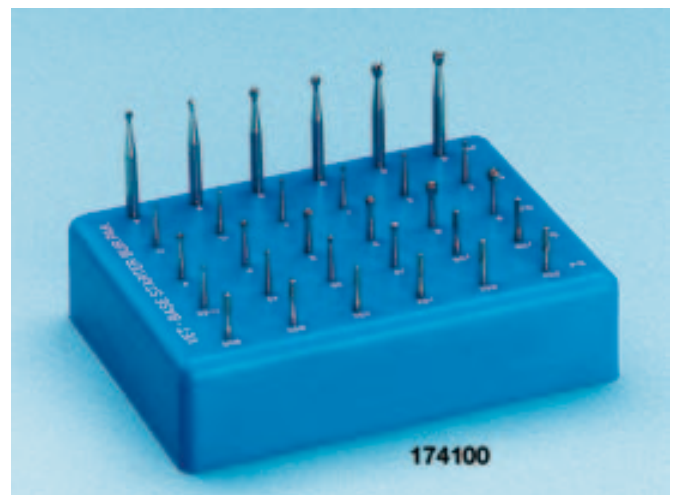

VETERINARY BUR KIT

For low-speed contra angle handpiece, containing:

- 1× diamond bur, size 12
- 1× diamond bur, size 23
- 1× cone bur, size 12
- 1× cone bur, size 18
- 1× straight dome bur, size 8
- 1× straight dome bur, size 12
- 1× wheel-type bur, size 12
- 1× bur, LINDEMANN pattern

174105

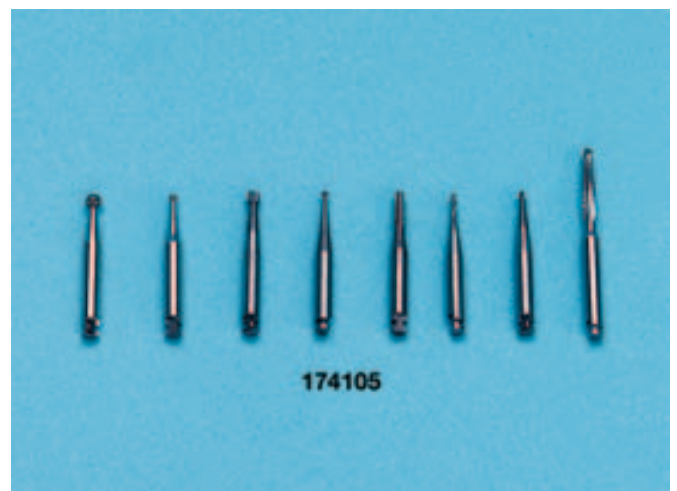

Bur Kits, Bur Guard, Cutting Disc



CARBIDE BUR KIT

For LOW-SPEED handpiece, containing:

- 1 excavating bur, size 18
- 1 tapered bur, size 14
- 1 tapered bur, size 23
- 1 cone bur, size 12
- 1 cone bur, size 21

174205

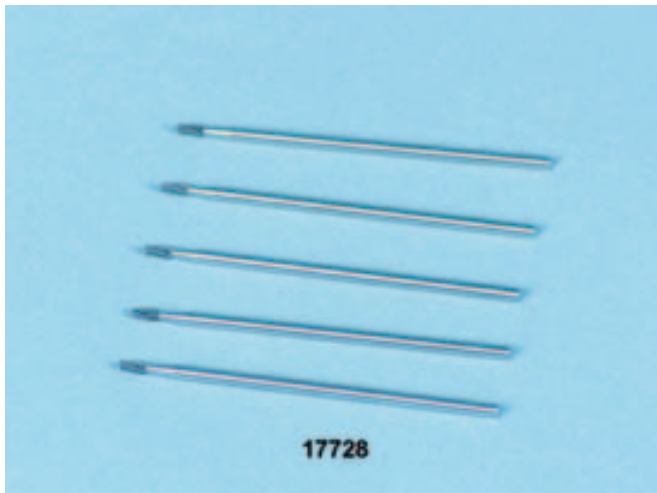

BUR KIT FOR RODENTS

For LOW-SPEED handpiece

- extra long shaft
- length = 44.5mm

177280



BUR GUARD

Mucosa protection – fits on straight handpiece

- prevents injuries caused by drilling

177282



DIAMOND CUTTING DISC SUPERFLEX

flexible, assembled

For straight handpiece

174450

For contra angle handpiece

174451

SAFETY SHIELD FOR DIAMOND DISC

Attaches to the handpiece
- prevents injury to the Vet and patient
- w/o handpiece
177284

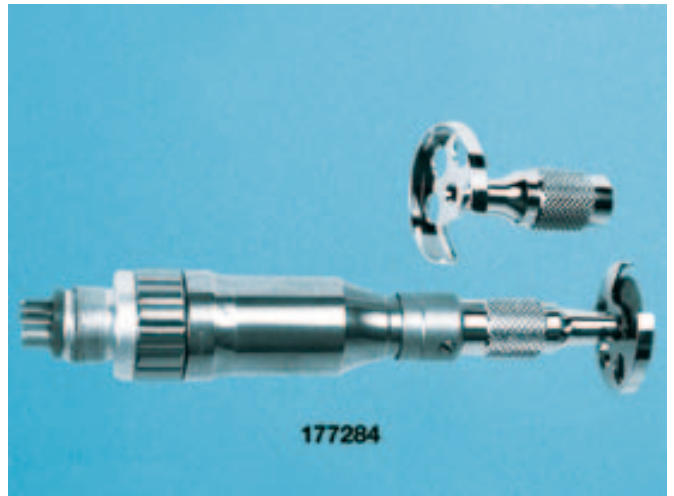

ANTI-DUST SPRAY

Anti-Dust Spray, 500ml, incl. spray nozzle
174880



CLEANING BRUSH

To clean burs, drills and milling cutters
174908



OIL SPRAY FOR ROTATING INSTRUMENTS

Spray for handpieces, 250ml, w/o adapter
174010

Adapter for contra angle handpieces
not illustrated
174011

Adapter for high-speed handpieces
not illustrated
174012



Guttapercha Points, Dental Root Set, Expansion Screw



GUTTAPERCHA-POINTS

- coloured
- for cats and dogs
- easy to open packaging

28mm, Set ISO 15–40

174816

28mm, Set ISO 45–80

174817

Absorbent Points medium, 55mm, 100/box

174803



GUTTAPERCHA-POINTS

55mm, 150 pcs assortment

- extra large for dogs

174813



DENTAL ROOT SET 60MM

For small animals

containing:

- 5x HEDSTROM file ISO 20/30/40/50/80
- 2x Lentulo, medium
- 1x Nerve Needle

174814

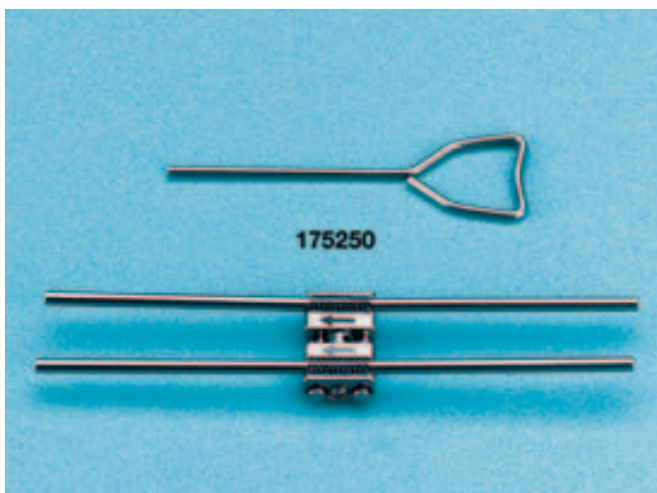

EXPANSION SCREW

With short (15mm) and long (21mm) screw and wrench

175250

DENTAL PROTECTION SHIELD

Perfect protection during dental treatment, including 3 exchangeable visors
- convenient for all dental procedures
940000



DENTAL MODELS

Transparent canine/feline dental models
- durable acrylic
- three dimensional view
- enables veterinarians to demonstrate the necessity of dental treatment

Cat
174092

Dog
174093

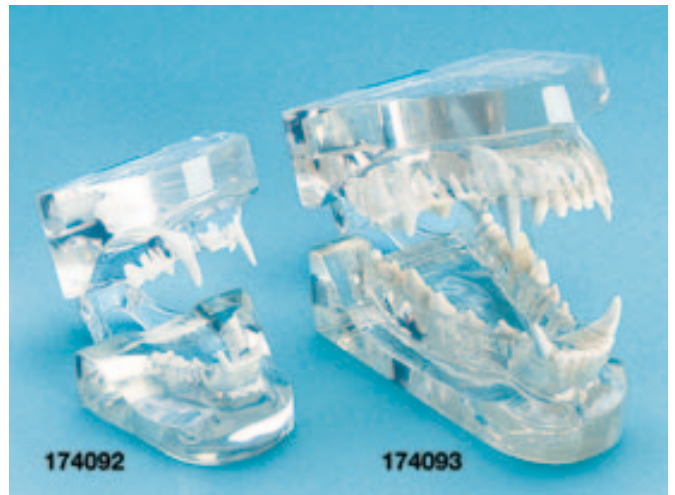

DENTAL ELEVATOR

Elevator BEIN, 13.5cm, 2mm
175302

Elevator BEIN, 13.5cm, 3mm
175303

Elevator BEIN, 13.5cm, 4mm
175304

Elevator LINDO-LEVIEN, 13.5cm, 3mm, serrated
175403

Elevator GEISSFUSS, 13cm
175613

Curved Elevator FAHRENKRUG, size 1, for dogs
175801

Curved Elevator FAHRENKRUG, size 2, for cats / small dogs
175802



Dental Forceps, Dental Hand Instruments



VET **Eickemeyer**®

Visit us on our website
www.eickemeyer.de



DENTAL FORCEPS AND TARTAR FORCEPS

- specially designed for dogs and cats teeth
- parallel jaws (while open)

Dental Forceps 11cm, for cats and small dogs
176011

Dental Forceps 11cm, for cats and small dogs,
diamond plated for optimal grip
176010

Dental Forceps 16.5cm, for dogs
176016

Dental Forceps 16.5cm, for dogs, diamond
plated for optimal grip
176015

Dental Forceps 16.5cm, for dogs, straight
176017

Tartar Forceps DIETRICH, 12cm, small, ideal
for removing heavy tartar
176112

Tartar Forceps DIETRICH, 16.5cm, large, ideal
for removing heavy tartar
176116

DENTAL FORCEPS

WITZEL, No. 166, 15cm, with narrow blades
- excellent for root fragments
176215

Right Angled Dental Forceps No. 13, curved
- excellent for small incisors and caudal teeth
176316

PERIODONTAL INSTRUMENTS

Supragingival Scaler JAQUETTE, 16.5cm, right
angled curved, double ended
176410

Scaler, 16.5cm, right angled curved, double
ended
176412

Dental Mirror with handle, D = 22mm
176422

Measuring Pocket Probe, 16cm
176456

Explorer Probe No. 9, to locate subgingival
calculus
176459

Exolorer Probe No. 17, to locate subgingival
calculus, ideal for cats
176467

TARTAR SCRAPERS AND SCALERS

- to remove tartar
- heavy duty model

Hook shaped

176401

With enamel chisel
not illustrated

176402

Universal Scaler, left

176403

Universal Scaler, right

176404

Hatchet shaped, sharp

not illustrated

176405

Hatchet shaped, sharp, heavy

176406

ULTRASONIC SCALER BANDELIN SONADENT C

With handle and 2 inserts

(universal and spatula tip)

Ultrasonic scaling equipment especially for
application in veterinary medicine

- dental scaler with high performance.
- long lasting titan nitride coated tips
- light weight handpiece

176800

Quick Release Attachment

- quick-change valve (for SONADENT / P5
BOOSTER / COCOON / EICKSONIC)

177000

Foot switch for SONADENT

177101

Handpiece with Finger Switch for SONADENT

177105



Ultrasonic Scalers



TIPS FOR SONADENT

Scaler Tip ML61, for SONADENT C, lengthwise
- for general scaling

176903

Scaler Tip ML16,
for SONADENT C,
spatula type
- for subgingival scaling

176904

Scaler Tip ML60, for SONADENT SD3A/SD3B,
lengthwise

176901

Scaler Tip ML15, for SONADENT SD3A/SD3B,
spatula type

176902

Urinary Tip HZ 13 LE, working length = 145mm

- to pulverise wedged calculus
- less traumatic than general surgery

176914

*Just plug in
the new processor
and fill it with chemicals
and the ECOMAX
is ready for operation.*



VEEickemeyer®

So ingeniously simple.

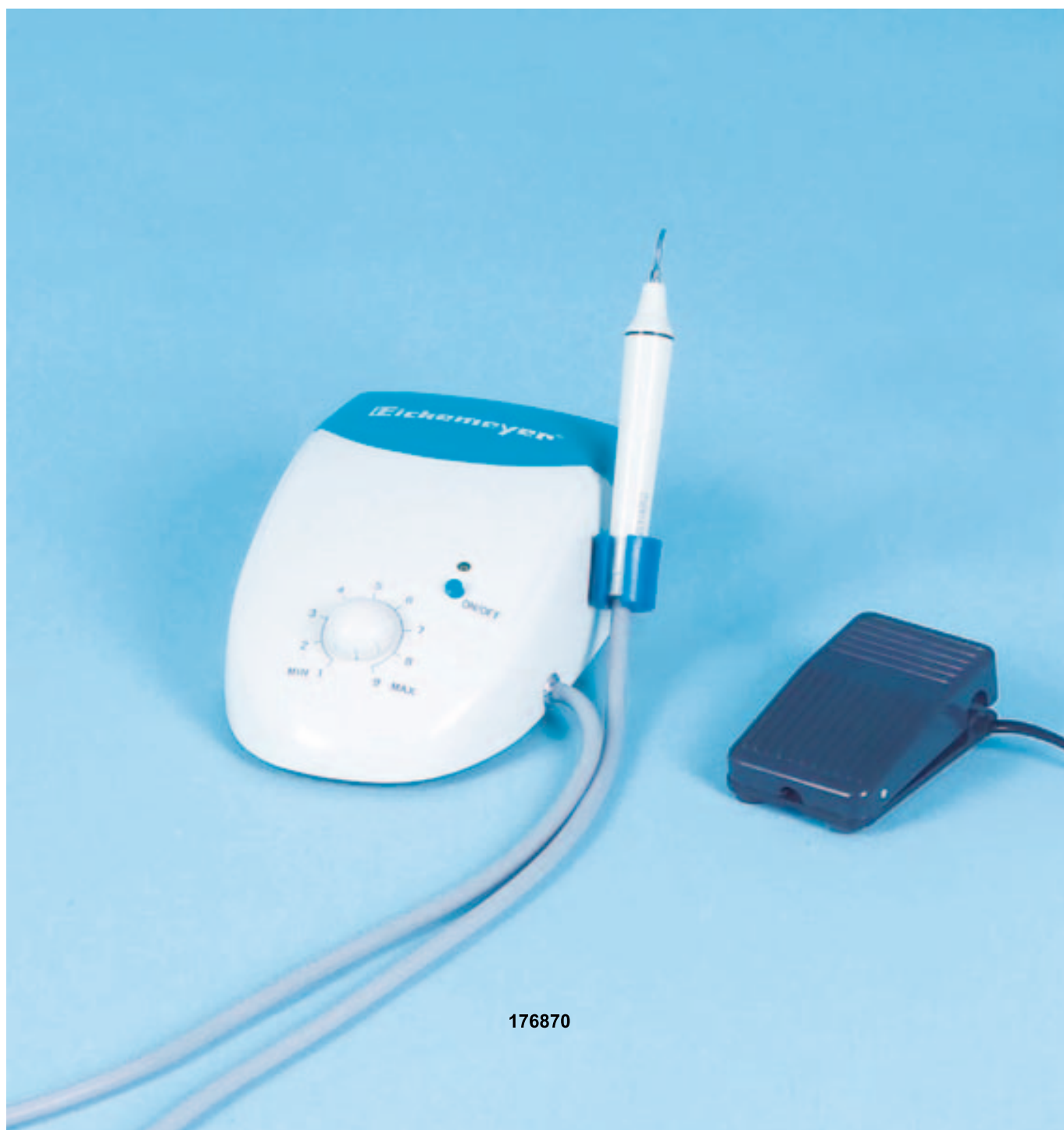

176870

ULTRASONIC SCALER EICKSONIC

- compact and light design
- ease of use
- modern Piezo-Technology
- control switch for easy water flow adjustment
- water source required (e.g. 176875)
- including 5 scaling tips
- very reasonable price

Ultrasonic Scaler EICKSONIC

176870

Scaler Tip No. 1 for 176870, flat, sharp

176871

Scaler Tip No. 2 for 176870, flat, wide

176872

Scaler Tip No. 3 for 176870, pointed

176873

Pump up Portable Water Tank for 176870, 5 litre, max. 3 bar

176875

Ultrasonic Scalers, Water Container, Dental Tray

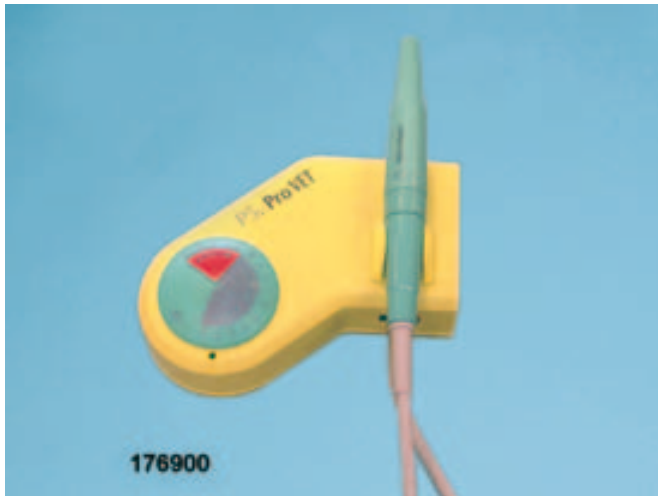

ULTRASONIC SCALER P5 BOOSTER

- the world's smallest Ultrasonic Scaler
- easy to handle with turn-switch adjustable in 4 steps and 14 power levels
- ultrasonic frequency precisely adjustable
- easy to clean
- lightweight titanium handle

P5 BOOSTER with handle and scalering Tip No.1
176900



TIPS FOR P5 BOOSTER AND COCOON

Scaler Tip No. 1

17690005

Scaler Tip No. 2

17690003

Urinary Tip for dogs, short (102mm)
not illustrated

17690007

Urinary Tip for cats, curved
not illustrated

17690008

Urinary Tip for dogs, large (150mm)
not illustrated

17690009



PORTABLE WATER TANK

- 5 litre
- stainless steel pressure tank, 2–5 bar
- D = 17cm, height: 53cm

177100

5 litre, with quick release coupling, plastic
not illustrated

17690002

Screw Adaptor M10 x 1,5, coupling nut for
portable water tank No. 177100

- fits on P5 BOOSTER and SONADENT
not illustrated

17710001



DENTAL TRAY

- Dimensions: L = 39x W = 35x H = 4.5cm
- stops water soaking back on to patient
 - comfortable positioning of the patients head
 - removable grate
 - easy to clean and disinfect
- 177200**

PROPHY PASTE AND CUPS

- perfectly shiny teeth with a highly polished enamel surface
- prophylaxis to tartar build up

Prophy Paste
176780

Rubber Prophy Cups Kit, containing:
 3x Brownie, 2x Greenie, 1x Super Greenie
 cupform and mini-point
176785



RODENT MOUTH GAGS

Ideal for examination and treatment of
 rabbit molars

SCHMIDTKE, 11.5cm, lightweight
177303

11cm, heavy model
177304



RODENT MOUTH GAG

Heavy model, 11cm, with ratchet, modified acc.
 to BIRKLE

- self retaining
 - one-hand-use
 - easy and fast locking/opening
- 177330**



RODENT CHEEK DILATORS

Cheek Dilator, large
 - blade width = 15mm / length = 21mm
177305

Cheek Dilator, small
 - blade width = 11mm / length = 14mm
177306

Cheek Dilator, for chinchillas and guinea pigs
 - blade width = 4mm (tip) / 9mm (back) /
 length = 21mm
177311

Cheek Dilator, small
 - with long blades
 - blade width = 10mm / length = 35mm
not illustrated
177310

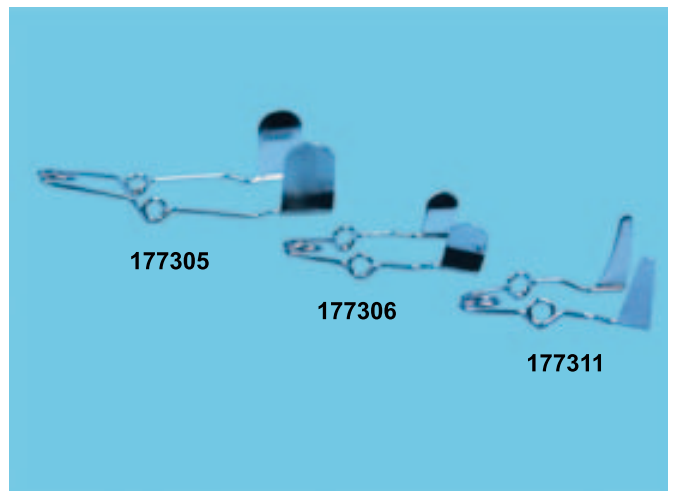

Tongue Spatula, Molar Cutters



TONGUE SPATULA

Tongue spatula, 17.5cm

177307

Tongue spatula HOLLMANN, small, concave blade, 19cm

177308

Tongue spatula HOLLMANN, large, concave blade, 19cm

177309

HEIDEMANN-Spatula for tooth extraction on rodents

not illustrated

174825



MOLAR CUTTERS WITH SPRING LOADED HANDLES

MINI-FRIEDMANN, 12cm, double spring, delicate

177312

MINI-FRIEDMANN, 14cm, double spring, very delicate

177314

Molar Cutter with spring, for Rabbits and Guinea Pigs, 18cm, curved

177315



MOLAR CUTTER WITH TUNGSTON CARBIDE INSERTS (TC)

- with double spring, 17cm

- use to de-bulk or for trimming spurs and hooks

- highest quality, extremely durable

- stay sharper, longer

177316



MOLAR CUTTER FOR CHINCHILLAS

- with spring, 13cm

- ergonomic design

177317

RODENT MOLAR RASP

To smooth off sharp edges w/o disturbing the delicate tooth roots

Diamond coated Molar Rasp, 18cm,
for small rodents, delicate
177319



WOODEN MOUTH GAGS

- secure and easy access to the mouth
- lightweight
- sturdy
- economically priced

Small, 7cm
200007

Large, 9cm
200009



SPRING ACTION MOUTH GAGS

- easy to handle
- less traumatic nylon/rubber inserts
- lightweight
- very durable

For dogs, small, 6.5cm
200107

For dogs, medium, 10.5cm
200110

For dogs, large, 15cm
200115

For cats, 6cm
200117

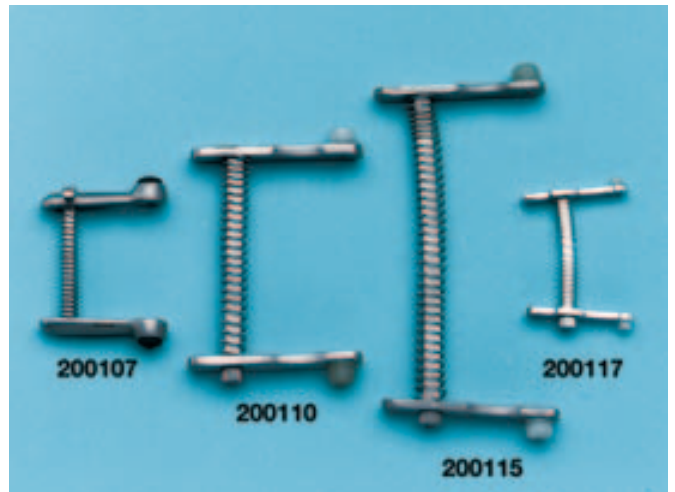

SMITH BAXTER MOUTH GAGS

Size 1, for cats
200201

Size 2, for small dogs
200202

Size 3, for medium dogs
200203

Size 4, for large dogs
200204



Equine Dental Forceps

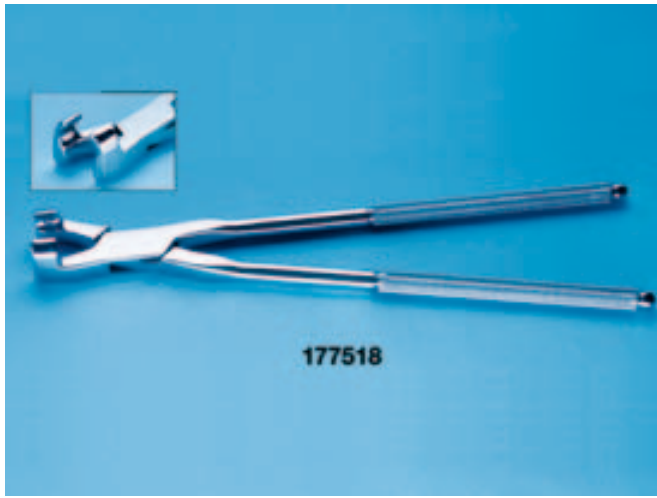

WORLD WIDE EQUINE MOLAR FORCEPS

- 48cm, serrated, short jaw, box joint, stainless steel
- with knurled handles
- engineered to be used with one or two hands
- fits short crowned molars and premolar caps well

177518

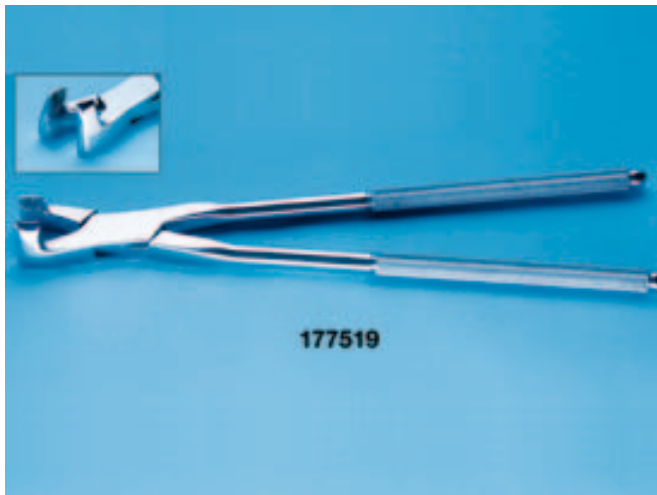

WORLD WIDE EQUINE MOLAR FORCEPS

- 48cm, concave, long jaw, box joint, stainless steel
- concave with knurled handles
- fits higher crowned molars well

177519

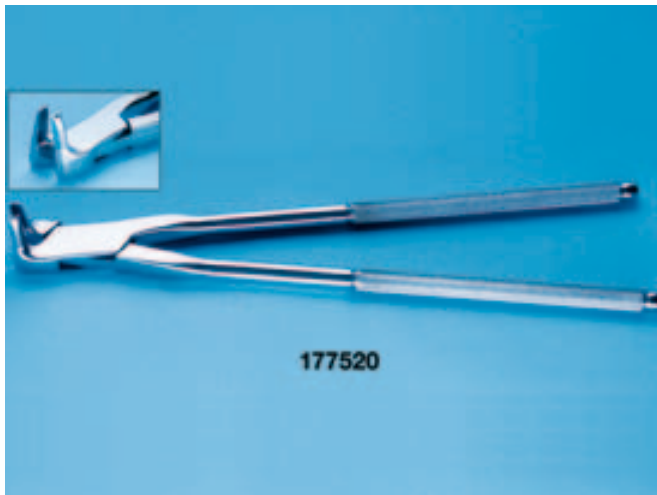

WORLD WIDE EQUINE ROOT FRAGMENT FORCEPS

- 46cm, short jaw, box joint, stainless steel
- with knurled handles
- used for removal of split and fractured molars

177520

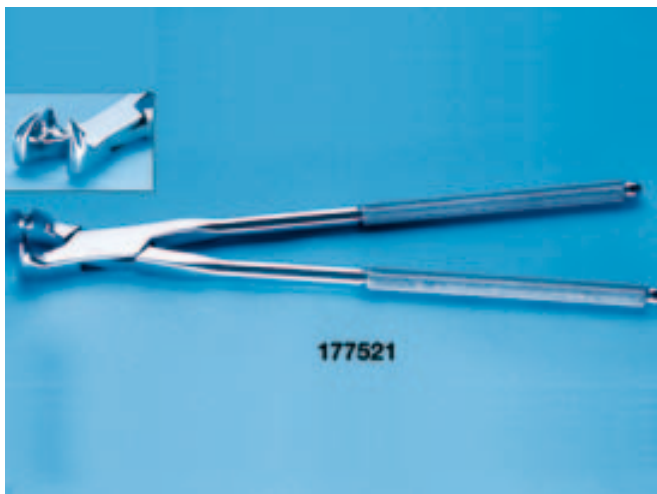

WORLD WIDE EQUINE MOLAR FORCEPS

- 48cm, three root, box joint, "off side", stainless steel
- with knurled handles
- for molars with very little crown in aged horses and deciduous premolar caps

177521

WORLD WIDE EQUINE MOLAR FORCEPS

48cm, three root, box joint, "on side", stainless steel

- with knurled handles
- for molars with very little crown in aged horses and deciduous premolar caps

177522

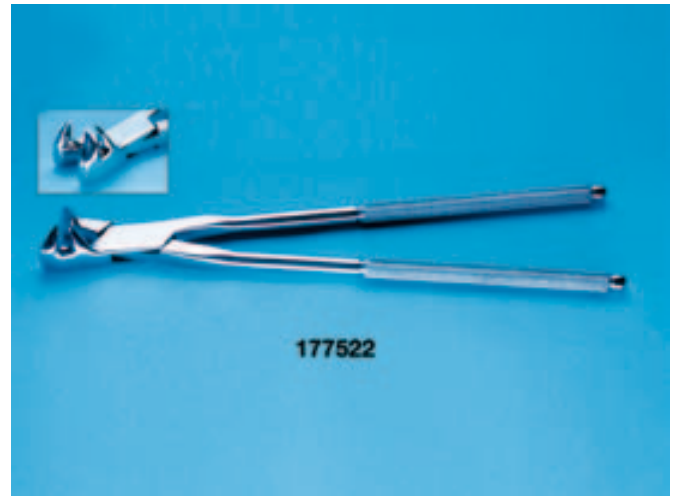

WORLD WIDE EQUINE MOLAR SPREADER

48cm, box joint, molar spreader, stainless steel

- with knurled handles
- for loosening premolar and molar teeth

177523

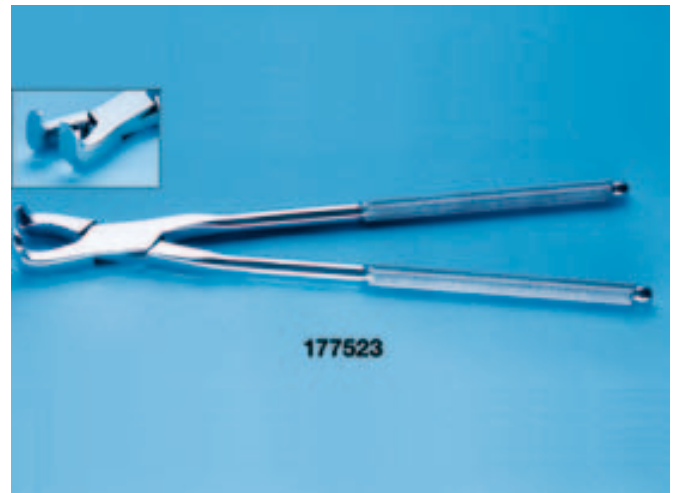

WORLD WIDE EQUINE EXTRACTOR REYNOLDS STYLE

43cm, heavy model, upper

177524

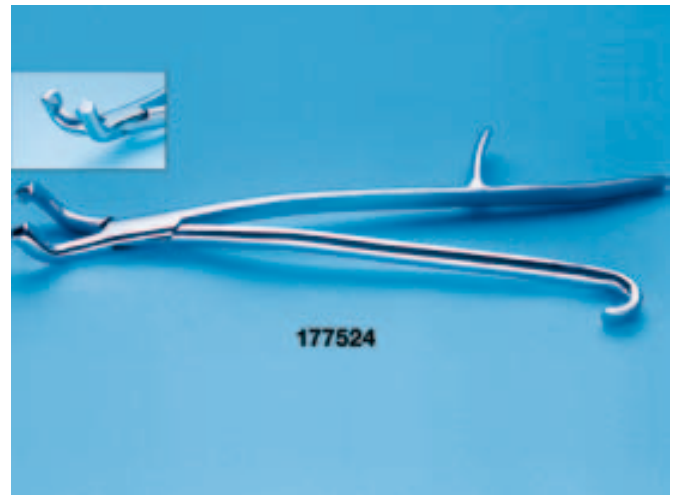

WORLD WIDE EQUINE EXTRACTOR REYNOLDS STYLE

43cm, heavy model, lower

177525



Equine Dental Forceps

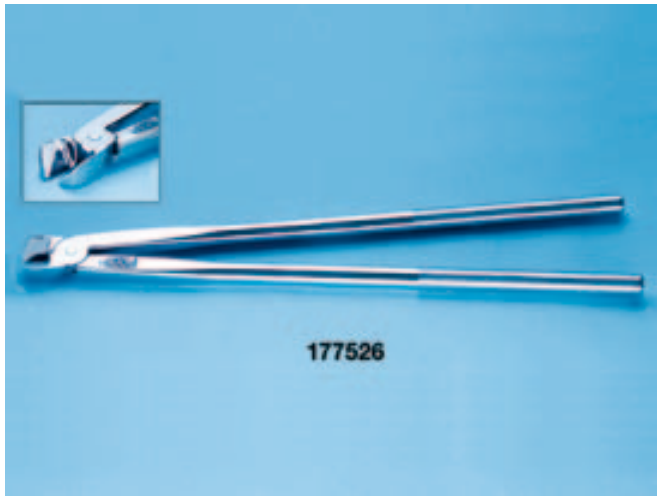

WORLD WIDE EQUINE LOWER MOLAR CUTTER

56cm, simple joint, lower molar cutter, hardened stainless steel
- with permanent handles
- works well on small back ramps and hooks
177526



WORLD WIDE EQUINE LOWER MOLAR CUTTER

56cm, simple joint, lower molar cutter, hardened stainless steel
- with permanent handles
- slightly opened head
- best selling cutter
177527

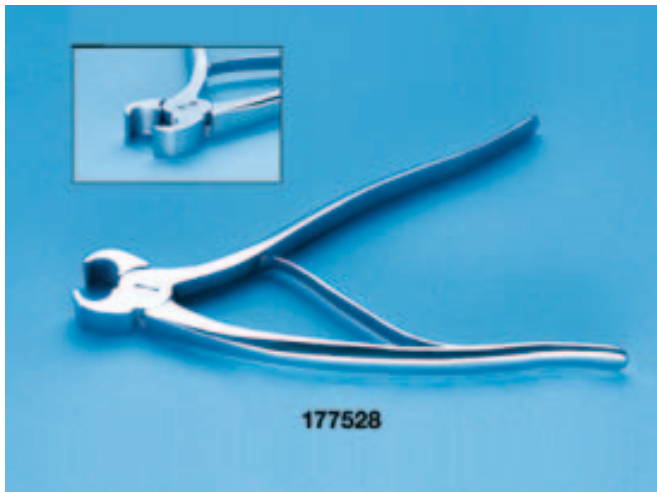

WORLD WIDE EQUINE TOOTH FORCEPS

25cm, Incisor and Canine Cutter
- for incisors that are scored and to reduce protuberant canine teeth
177528

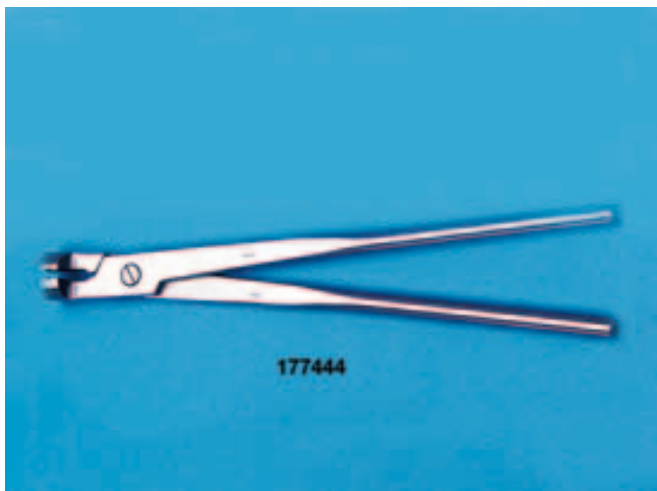

EQUINE EXTRACTION FORCEPS

GUENTHER, 44.5cm
177444

MOLAR CUTTER

- 75cm, hardened stainless steel
 - powerful compound action
 - with detachable handles for easy storage
- 177450**



TREPHINE PUNCHES WITH SERRATED HEADS

- 20cm, straight
- 177620**
- 20cm, curved
- 177720**

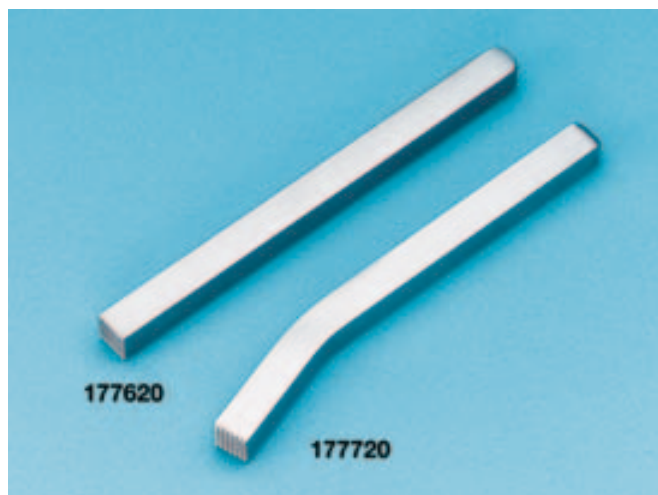

DENTAL ELEVATOR SET FOR HORSES

- contains 4 elevators (medial, lateral, posterior and anterior)
 - works well on incisor or molar fragments
 - length = 40cm
- 177517**

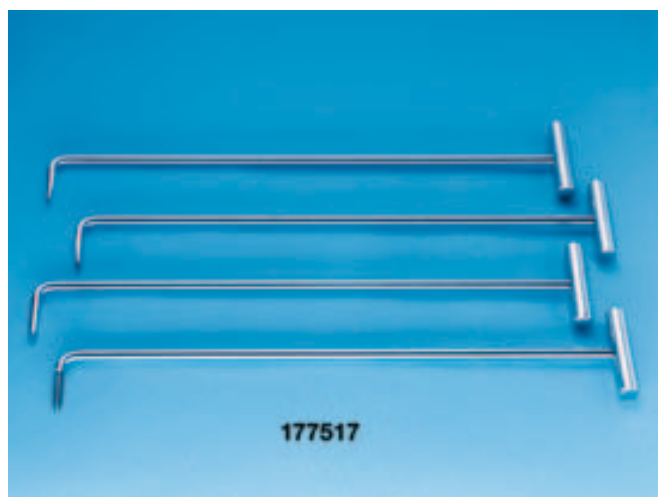

WORLD WIDE EQUINE ELEVATOR

- 8mm head
 - palm fitting hexagon handle
 - especially for elevating incisors and wolf teeth
- 177515**

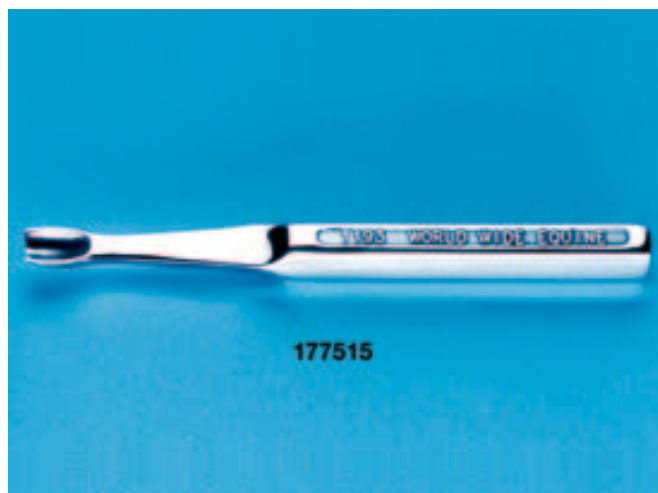

Equine Elevator, Wolf Tooth Elevator Kit, Trephine, Equine Tooth Rasps

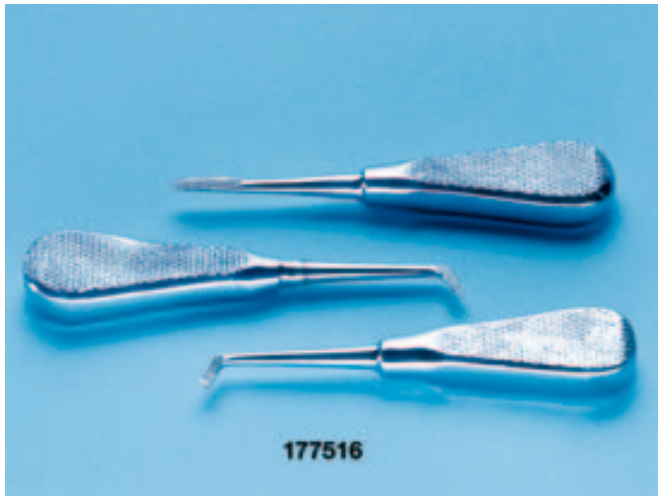

WORLD WIDE EQUINE ELEVATOR SET

- contains 3 elevators (straight, left and right)
 - for removing wolf teeth, incisors, and deciduous tooth fragments
 - length = 15cm
 - 3mm head
- 177516**



WOLF TOOTH ELEVATOR KIT

- Spare Head, small D = 8mm
177761
- Spare Head, large D = 10mm
177762



GALT TREPHINE

- With removable handle
- With cutting head 19mm + 22mm
184910
- With cutting head 19mm + 25mm
184911



WORLD WIDE EQUINE TOOTH RASP

- Pro-Lite
- 28cm, with round shaft, head angle 20°, w/o blade
177505
- 23cm, with round shaft, head angle 25°, w/o blade
177504

WORLD WIDE EQUINE TOOTH RASP

Pro-Lite

38cm, with round shaft, straight, w/o blade

177506

43cm, with round shaft, straight, w/o blade

177507

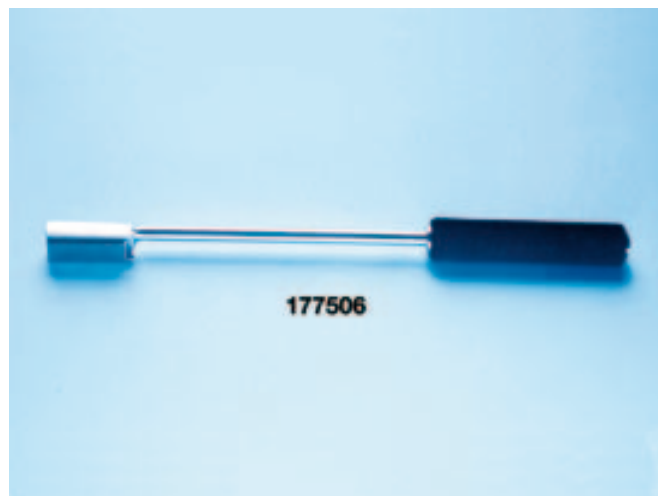

WORLD WIDE EQUINE TOOTH RASP

Slim-Line Pro-Lite

46cm, with round shaft and marking scale, head angle 15° up, with carbide blade

177510



WORLD WIDE EQUINE TOOTH RASP

Slim-Lin

23cm, with curved shaft, premolar and bit seat rasp, with carbide blade

177511



WORLD WIDE EQUINE CURVED TOOTH RASP

S-shaped, Tungsten Carbide chip

- length = 51cm

- width = 3.8cm

177512



Tooth Rasps Blades, Stainless Steel Bucket, Equine Tooth Rasps

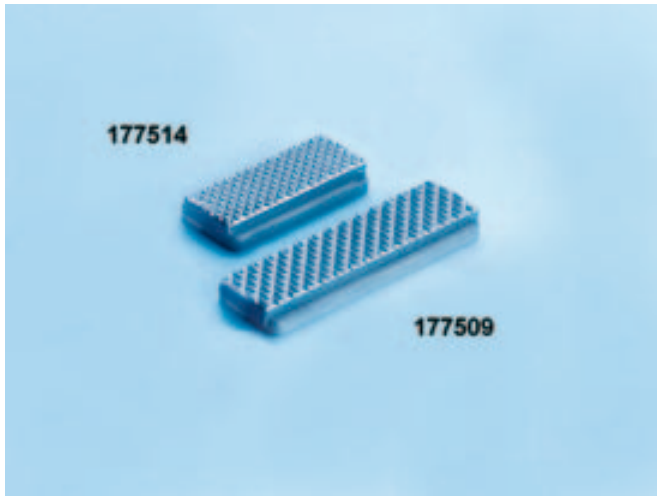

WORLD WIDE EQUINE TOOTH RASP PLATES

Tungsten Carbide, medium, for Peo-Lite Tooth Rasp 3.25 inch

177509

Tungsten Carbide, medium, for Pro-Lite 2.25 inch

177514



EQUI VET BUCKET

Stainless steel, with integrated brush and rubber bottom

- especially for cleaning tooth rasps during treatment
- the rubber bottom keeps noise levels to a minimum around nervous animals

178390



TOOTH RASP MULTIFLOAT

Dental Rasp "Multifloat"

- 12 different angles to perform all dental procedures
- angles can be easily adjusted
- no tools required
- incl. heavy duty Tungsten Carbide chip blade
- easy exchange of the blade
- complete stainless steel construction
- working length = 48cm

177600

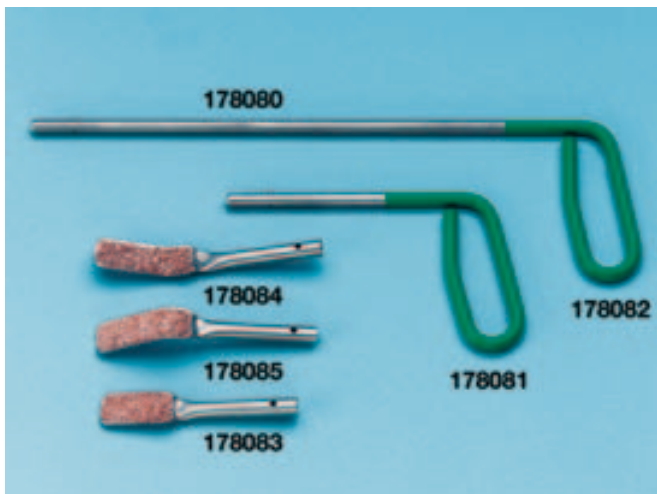

TOOTH RASP SYSTEM EQUI DENT

EQUI DENT Set, including:

- 2 handles 17 and 40cm
- 3 exchangeable rasp tops with TC chip blades

178080

Handle short, 17cm

178081

Handle long, 40cm

178082

Top with TC chip blade, straight

178083

Top with TC chip blade, curved up, excellent for rear molars

178084

Top with TC chip blade, curved down
- for use on upper arcade molars

178085

WORLD WIDE EQUINE NYLON DENTAL HALTER

Nylon Dental Halter with quick release, double braided nylon rope and steel bar in halter for hanging heads

177555

Quick release, one handed height adjustment

177601372



177555

EQUINE TOOTH RASPS SLIMLINE

- RECHARGEABLE battery powered (up to 9000 rpm)
- special flat head for reaching the rear molars
- durable stainless steel cabinet
- ergonomic design
- overload protection
- lightweight and easy to use

SLIMLINE incl. charger

178150

Spare battery for Tooth Rasp SLIMLINE

178152

Like 17815502 but with rechargeable power-battery-pack

- lasts more than 4 hours, connectable to a car (12V)

178155



DISCS FOR TOOTH RASP SLIMLINE

- diamond-plated
- long-lasting

Disc, coarse

178157

Disc, fine

178158

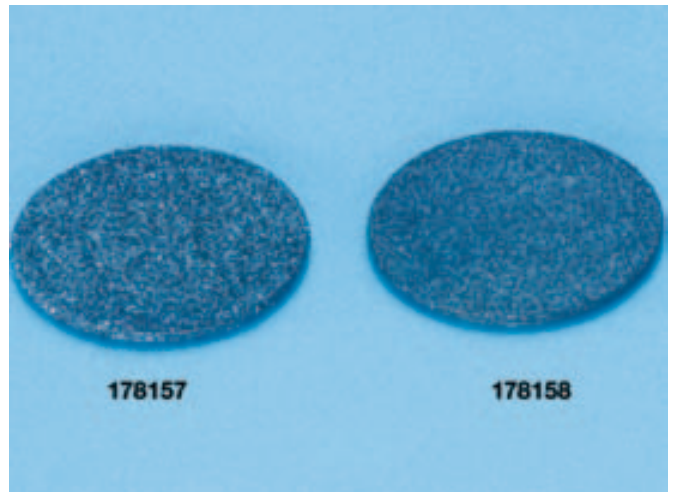

ELECTRIC TOOTH RASP SWISSFLOAT-EISENHUT

Easily reduces unevenness of equine molars

- slim model, length = 65cm
- very flat head (only 22mm)
- adjustable from 0–1900 rpm
- safety net plug
- low-noise
- saves time and energy
- incl. Tungsten Carbide disk (178104)

178111



Electric Equine Tooth Rasps

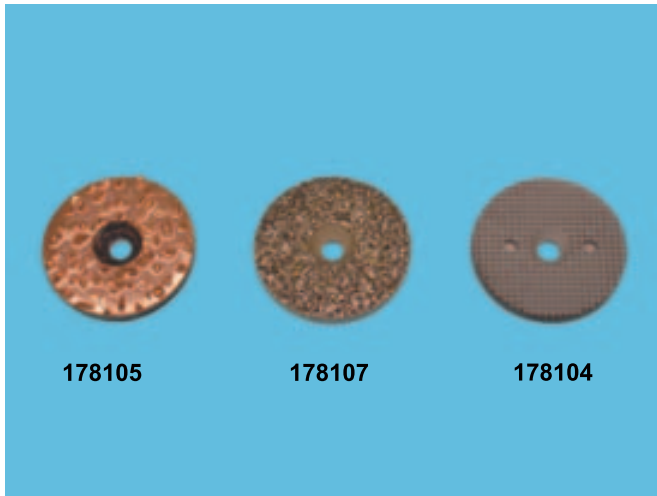

DISCS FOR SWISSFLOAT-EISENHUT

Tungsten Carbide Disc

178104

Diamond Disc, fine

- long-lasting, for more than 100 treatments
- quick and efficient

178107

Diamond Disc Golden Line, flat

- plated with diamond chips
 - long-lasting and easy to clean
- not illustrated*

178108

SuperCut Disc EICKEMEYER

not illustrated

178105

ELECTRIC TOOTH RASP EICKEMEYER

EICKEMEYER Motor with foot switch and protective switch

- high performance 300 Watts engine
- foot switch splash-water protected
- dust proof
- electronic speed regulation from 0 up to approx. 12.000 U/min.

177585

Flexible shaft for 177585, length 100cm

177586

ELECTRIC TOOTH RASP EICKEMEYER

- head and blade made of stainless steel
- handle made of aluminium
- including disc and grease gun
- low profile head
- easy handling

177580

Disc for electric toothrasp

177583

WORLD WIDE EQUINE HORSEPOWER HANDPIECE

The handpiece for professionals

- overall length = 45.5cm, shaft = 32cm
- works well in most positions on molars
- low profile head
- incl. diamond disc and guard
- fits on DREMEL/FOREDOM/EICKEMEYER motor

177551

Diamond disc for 177551

177552

Special lubricating grease for 177551

177553

Grease gun "De Luxe" for 177551

177554

**WORLD WIDE EQUINE HORESEPOWER
HANDPIECE APPLE CORE**

Motor attachment

- unguarded handpiece uses the apple core burrs for bucal cusps, bit seats and radius work on cheek teeth battery edges
- comes with a diamond coated apple core burr
- lenght = 45.5cm

177601315

**MAINTENANCE AND REPAIR OF EQUINE
DENTAL EQUIPMENT**

Eickemeyer after sales service.

You can rely on us

- fast and relieable in our own shop

HANDPIECE FOR EICKEMEYER MOTOR

EICKEMEYER Handpiece

- suitable for DREMEL engines with flexible shaft
- large hand piece with 2 draw-in attachments for 1/8" and 1/4" cutter

177531

EICKEMEYER HANDPIECE GUARD

For EICKEMEYER handpiece

177533

Apple Core, Electric Equine Tooth Rasps



VET Eickemeyer®

Maintenance and repair of
equine dental equipment

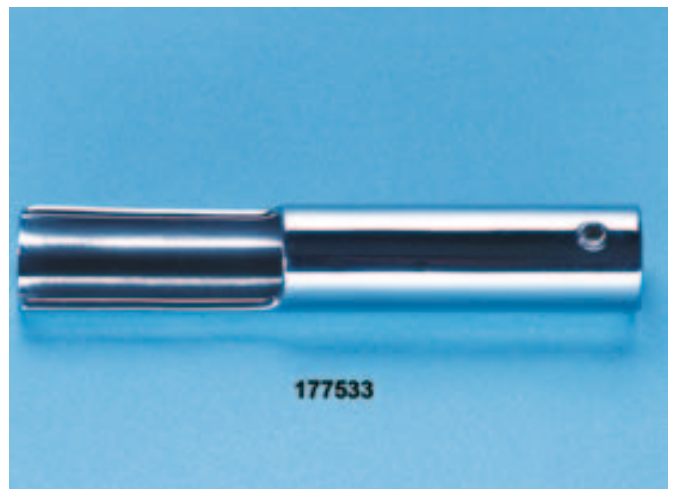

Carbide Burs, Diamond Cutting Disc



CARBIDE BURS FOR EICKEMEYER-HANDPIECE

Ball burr, diamond cut, D = 1.3cm, for 177531
177535

Drum burr, diamond cut, D = 1.6cm, for 177531
177536

Apple core burr, concave, 1/4" shaft
177601299

Drum Bur, D = 1.3cm, for 177531
17753601

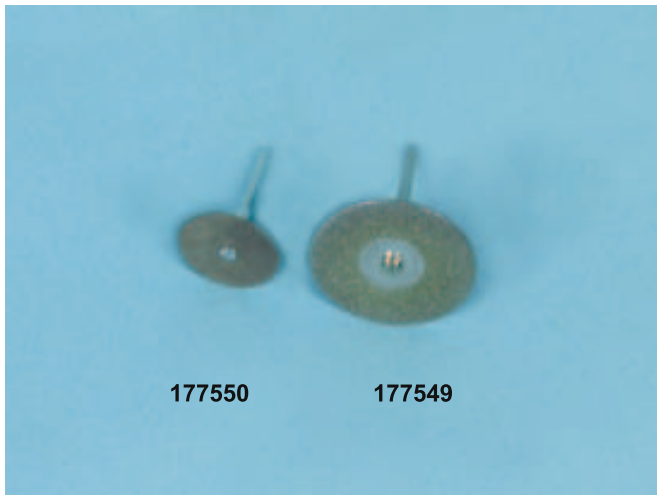

DIAMOND CUTTING DISC

large, D = 4cm
177549

Diamond cutting disc
D = 2.2cm, double sided, for 177531
177550



SUCTION ATTACHMENT "SUPER SLOBBER SUCKER"

attaches to vacuum cleaner

177601398

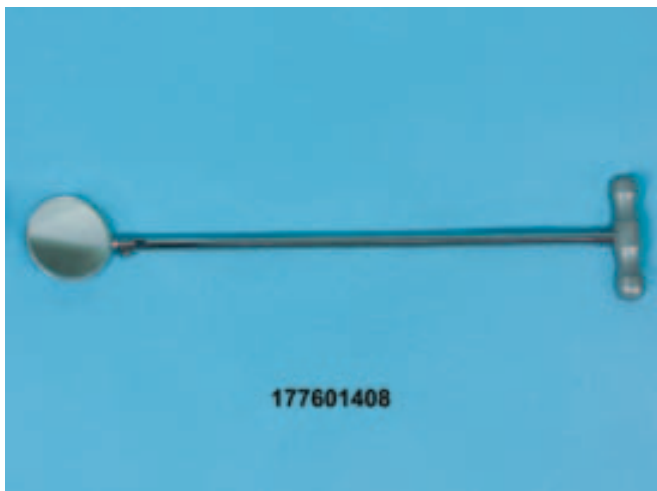

EQUINE DENTAL MIRROR

Large mirror (D = 5 cm) for perfect view,
35cm length with T-handle
177601408

Hypomochlion, Equine Mouth Speculum

HYPOMOCHLION

With two different plateaux
177537

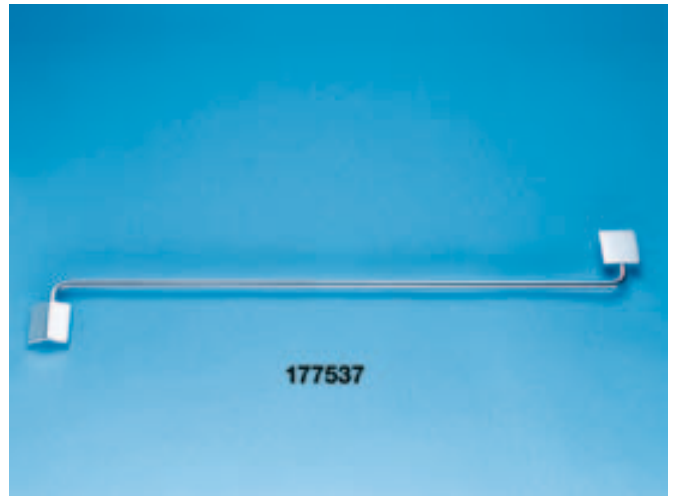

WORLD WIDE EQUINE MOUTH SPECULUM

Series 2020

- stainless steel
- with 15 clicks for easy adjustment
- improved handling
- double stitched belts
- with interchangeable ratchet inserts

177529

Series 4000

- heavy duty stainless steel
- with 6 ratchets

not illustrated

177601445



Equine Mouth Speculum, Equine Mouth Wedges



HAUSSMANN/CLIMAX MOUTH SPECULUM

- high grade forged stainless steel
- spring loaded ratchets on both sides for easy opening
- easy adjustment
- quality stitched leather halter

211015

Real Bone Horse Skull

909011



EQUINE MOUTH WEDGES

Mouth Wedge COMET, plastic

210008

Mouth Wedge SCHOUPE, metal

210009

Mouth Wedge with rubber block

- with atraumatic rubber block
- extremely durable
- easy replacement of rubber block

210013

Spare rubber block for Mouth Wedge 210013

E210013001



EQUINE MOUTH WEDGE

Stainless steel with poly wedge, poll strap and off cheek hook

177530

DENTAL TREATMENT DVD

DVD Introduction to Equine Dentistry
177599
 DVD Incisor and Molar Malocclusions
177598



177598

EAR FORCEPS

TROELTSCH, 13cm
134113
 LUCAE, 14cm
134214

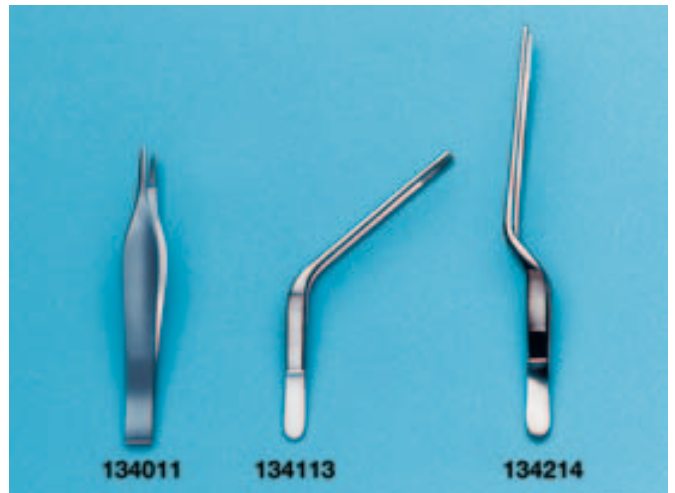

134011

134113

134214

HAEMATOMA COMPRESS

Pack with 10 pcs.
 - 12x18cm
 - for aural haematoma treatment. Easy to cut to shape, good ventilation, sterile
173920



173920

EAR CLEANING INSTRUMENTS

- perfect ear cleaning with ease
 Ear Loop BUCK, 15cm, curved, blunt
 - for general ear cleaning
173615
 Flexible Ear Loop BILLEAU, 16.5cm, No. 2
 - specially designed for cats ears
173716
 Forceps for ear hair removal
173750
 Cotton applicator, 14cm, 1.2mm
173812
 Cotton applicator, 18cm, 1.5mm
173815
 Cotton applicator, 18cm, 1.8mm
173818

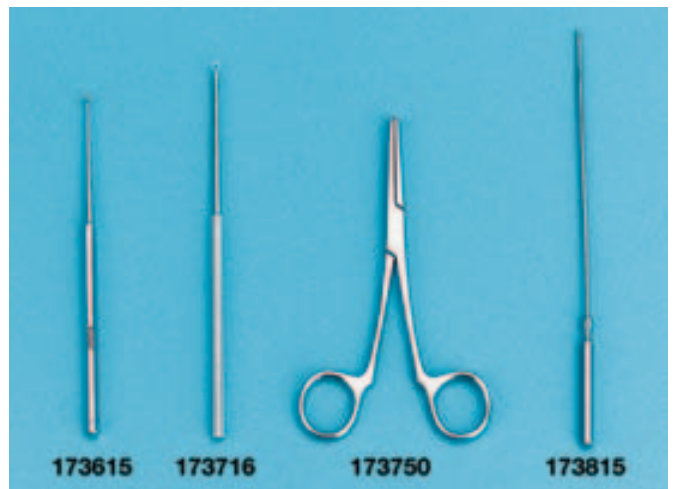

173615

173716

173750

173815

Ear Irrigation, Bulb Syringes, WOODS Lamps



AURIFLUSH EAR IRRIGATION SYSTEM

Faster, easier and more effective way to clean ears of small animals

- especially designed for veterinary use
- max. pressure 10PSI to avoid injuring the ear drum
- latex-free disposable eartips provide a tight seal within the patient's external ear canal
- water flow is regulated easily with the handle actuator
- injection port for administration of ear cleaning agents
- integrated temperature sensor
- easily attaches to most taps
- well-tolerated in unsedated dogs & cats

173940

Disposable tips for 173940, 100/box
173941



BULB SYRINGE

90ml

- red rubber
- to aspirate fluids

453690



WOODS LAMP

- maximum ultraviolet irradiance
- magnification

WOODS Lamp, 230V, 4x 40W

179010

WOODS Lamp with additional lens
(12 dpt, D = 3cm)

179015

UV Lamp, hand held

not illustrated

179050

HEINE DELTA 10 DERMATOSCOPE

For dermal diagnosis and evaluation

- 10x magnification
 - detailed picture
 - bright illumination
 - easy to use
 - fits on HEINE 3.5V rechargeable handle
- 179435**



EXTERNAL FIXATION CLAMPS

KIRSCHNER pattern

Single, 2.4mm, small
180010

Single, 3.2mm, medium
180011

Double, 3.2mm, small
180020

Double, 4.8mm, medium
180021



EXTERNAL FIXATION BARS

For single and double clamps

D = 3.2mm, L = 5.0cm, small
180031

D = 3.2mm, L = 7.6cm, small
180032

D = 3.2mm, L = 10.0cm, small
180033

D = 3.2mm, L = 12.7cm, small
180034

D = 3.2mm, L = 15.0cm, small
180035

D = 4.8mm, L = 7.6cm, medium
180041

D = 4.8mm, L = 10.0cm, medium
180042

D = 4.8mm, L = 15.0cm, medium
180044

D = 4.8mm, L = 17.8cm, medium
180045

D = 4.8mm, L = 20.3cm, medium
180046

D = 4.8mm, L = 25.4cm, medium
180047

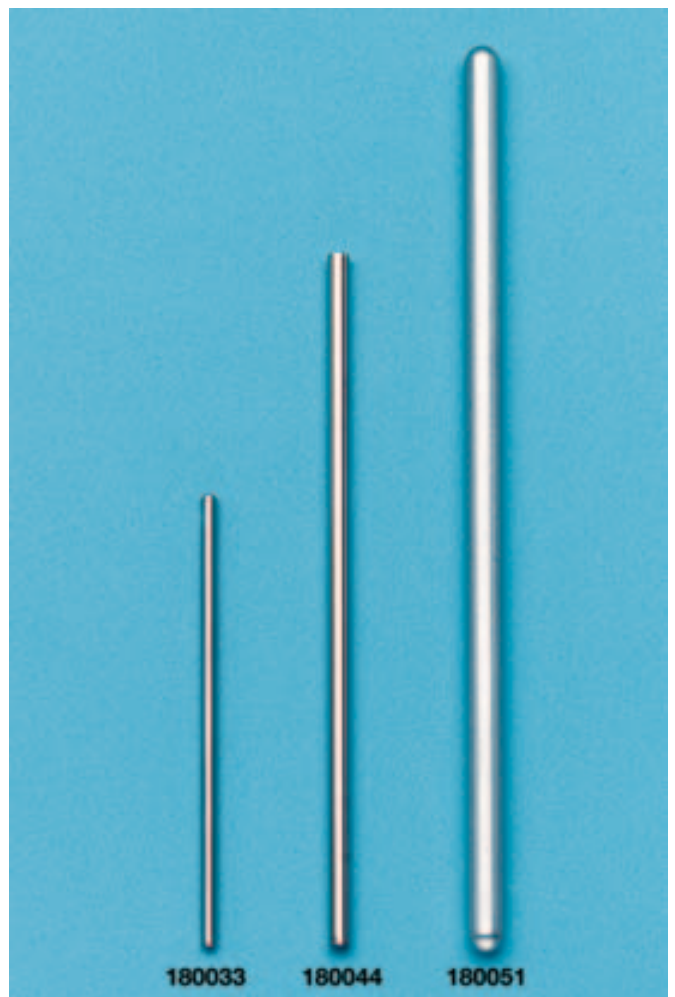

KIRSCHNER Trocar Pins, KIRSCHNER-ELLIS Pins, External Fixation Kit

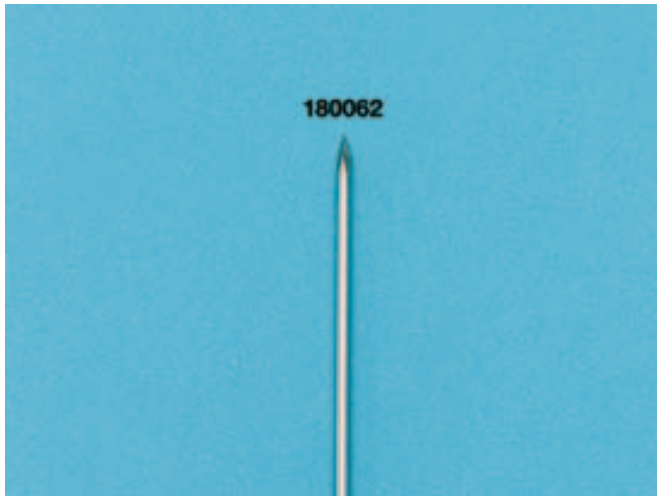

KIRSCHNER TROCAR PINS

Double trocar point, for use with KIRSCHNER external fixation clamps

D = 2.4mm, L = 20.3cm

180062

D = 3.2mm, L = 22.9cm

180063

D = 4.0mm, L = 22.9cm

180064

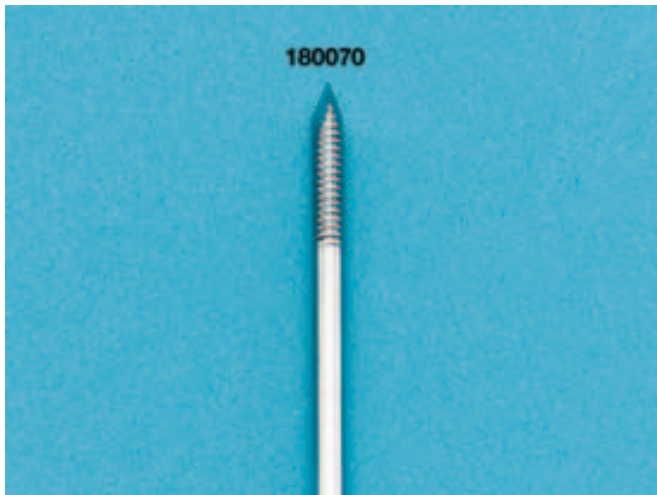

KIRSCHNER-ELLIS PINS

Negative threaded pin with round end, for use with KIRSCHNER external fixation clamps

D = 2.36mm, L = 11.5cm, small

180070

D = 3.12mm, L = 13.0cm, medium

180071



EXTERNAL FIXATION KIT, SMALL

For cats and dogs up to 10kg

contains:

- 180010 single clamp, 2.4mm, small, 8 pcs
- 180020 double clamp, 3.2mm, small, 2 pcs
- 180031 bar, D = 3.2mm, L = 5.0cm, small, 2 pcs
- 180035 bar, D = 3.2mm, L = 15.0cm, small, 2 pcs
- 180085 wrench, small
- 180062 STEINMANN pins, double trocar point, D = 2.4mm, L = 20.3cm, 4 pcs
- 180490 STEINMANN pins with positive mid thread, D = 2.4mm, L = 10.2cm, thread: D = 3.2mm, 4 pcs
- 180496 STEINMANN pins with positive end thread, D = 2.4mm, L = 10.2cm, thread: D = 3.2mm, 6 pcs

180110

EXTERNAL FIXATION KIT, MEDIUM

For dogs up to 20kg

Contains:

- 180011 single clamp, 3.2mm, medium, 8 pcs
- 180021 double clamp, 4.8mm, medium, 2 pcs
- 180041 bar, D = 4.8mm, L = 7.6cm, medium, 2 pcs
- 180046 bar, D = 4.8mm, L = 20.3cm, medium, 2 pcs
- 180086 wrench, medium
- 180063 STEINMANN pins, double trocar point, D = 3.2mm, L = 22.9cm, 4 pcs
- 180491 STEINMANN pins with positive mid thread, D = 3.2mm, L = 12.7cm, thread: D = 4.0mm, 4 pcs
- 180497 STEINMANN pins with positive end thread, D = 3.2mm, L = 12.7cm, thread: D = 4.0mm, 6 pcs

180120

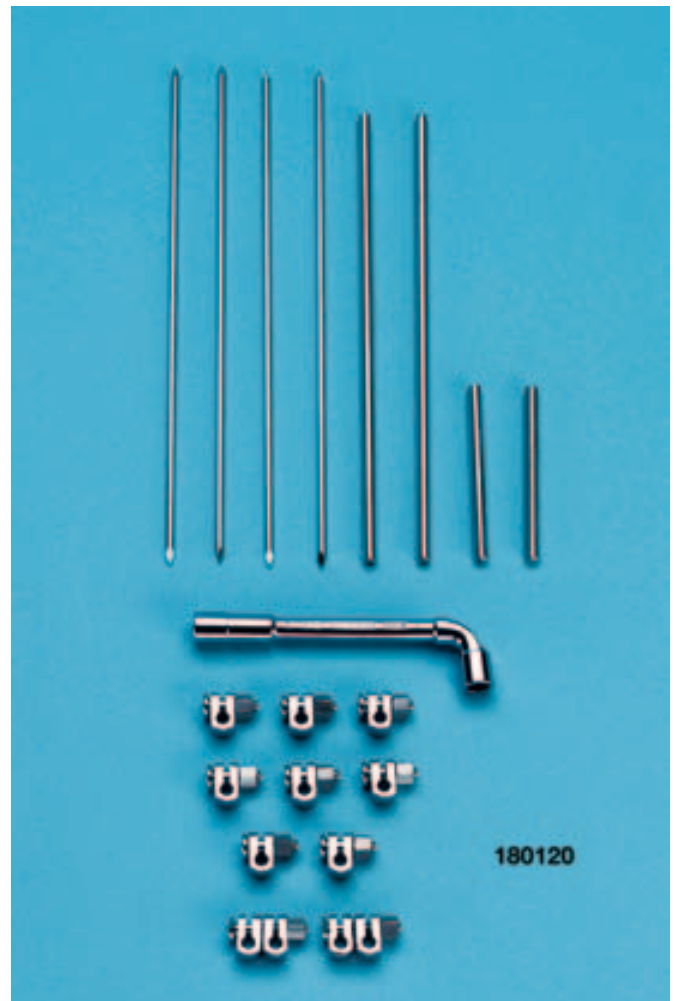

STEINMANN PINS WITH POSITIVE THREAD

For use with KIRSCHNER external fixation clamps

- thread extending above the smooth shank
- available with mid or end thread
- highest quality implant steel
- improved pull out resistance

D = 2.4mm, L = 10.2cm, mid thread: D = 3.2mm
180490

D = 3.2mm, L = 12.7cm, mid thread: D = 4.0mm
180491

D = 4.0mm, L = 15.2cm, mid thread: D = 4.8mm
180492

D = 0.9mm, Interface: D = 1.2mm, length 7.5cm
180501

D = 1.6mm, Interface thread: D = 1.9mm, length 7.5cm
180503

D = 2.4mm, L = 10.2cm, end thread: D = 3.2mm
180496

D = 3.2mm, L = 11.6cm, end thread: D = 4.0mm
180497

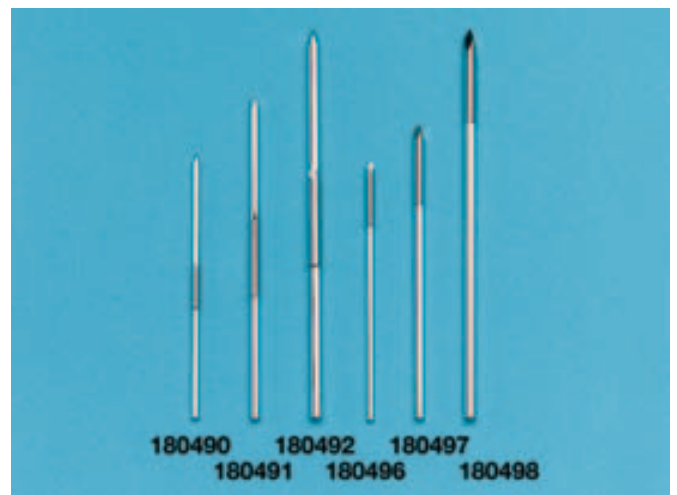

STEINMANN Pins

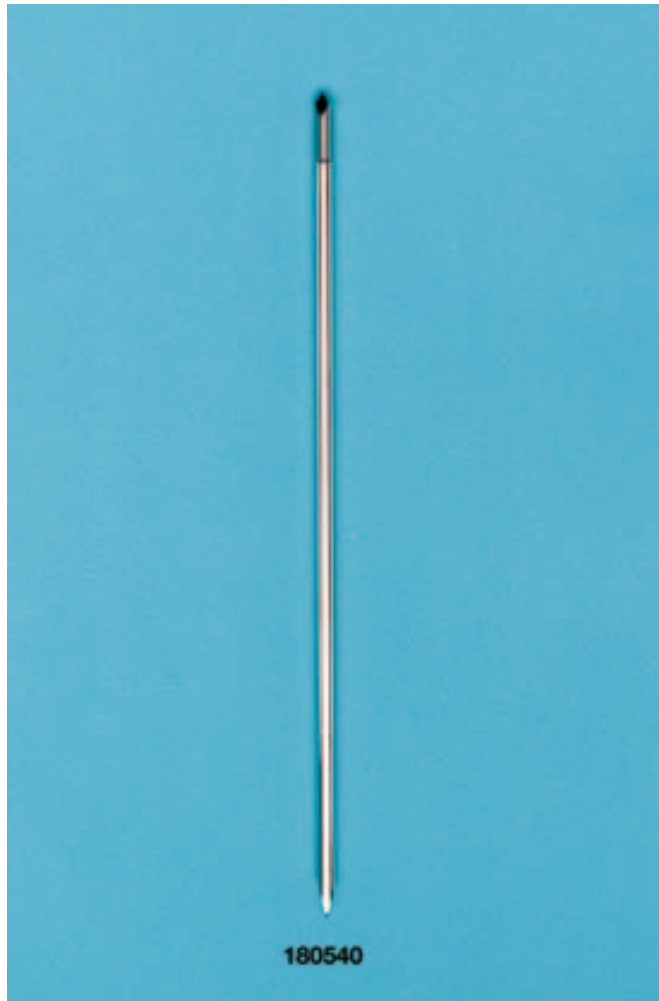

180540

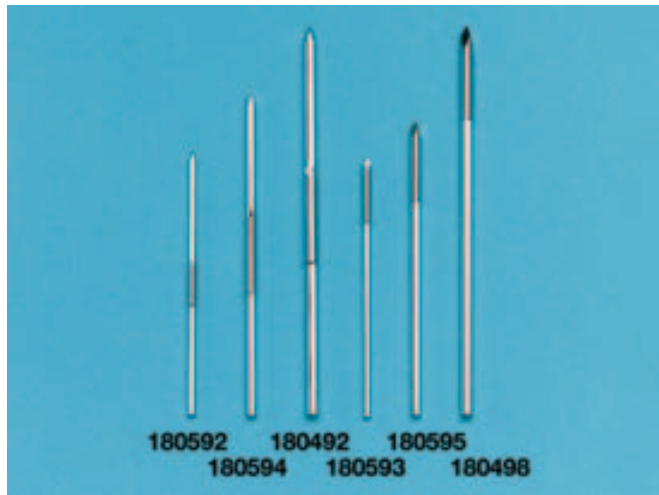

180592 180492 180595
180594 180593 180498

STEINMANN PINS WITH NEGATIVE THREAD

For use with the metric system
- the thread is similar to a self-taping
cortical screw

D = 1.2mm, L = 18cm

180512

D = 1.5mm, L = 18cm

180515

D = 2.0mm, L = 18cm

180520

D = 2.5mm, L = 20cm

180525

D = 3.0mm, L = 23cm

180530

D = 4.0mm, L = 25cm

180540

D = 5.0mm, L = 30cm

180550

D = 6.5mm, L = 31cm

180565

STEINMANN PINS WITH POSITIVE THREAD

For use with the metric system
- thread extending above the smooth shank
- available with mid or end thread
- highest quality implant steel
- improved pull out resistance

D = 2mm, L = 9.7cm, mid thread: D = 2.5mm

180592

D = 3mm, L = 12.2cm, mid thread: D = 3.5mm

180594

D = 2mm, L = 9.7cm, end thread: D = 2.5mm

180593

D = 3mm, L = 11.0cm, end thread: D = 3.5mm

180595

D = 4.0mm, L = 15.2cm, end thread:

D = 4.8mm

180498

TROCAR PINS

For use with the metric system

- highest quality implant steel
- special long point
- Trocar / Bayonet point
- length = 15cm
- 10/box

D = 0.8mm

180608

D = 1.0mm

180610

D = 1.2mm

180612

D = 1.4mm

180614

D = 1.6mm

180616

D = 1.8mm

180618

D = 2.0mm

180620

D = 2.2mm

180622

D = 2.5mm

180625

D = 3.0mm

180630

TROCAR PINS

For use with the metric system

- highest quality implant steel
- special long point
- Trocar / Trocar point
- length: 15cm
- 10/box

D = 0.8mm

180758

D = 1.0mm

180760

D = 1.2mm

180762

D = 1.4mm

180764

D = 1.6mm

180766

D = 1.8mm

180768

D = 2.0mm

180770

D = 3.0mm

180780

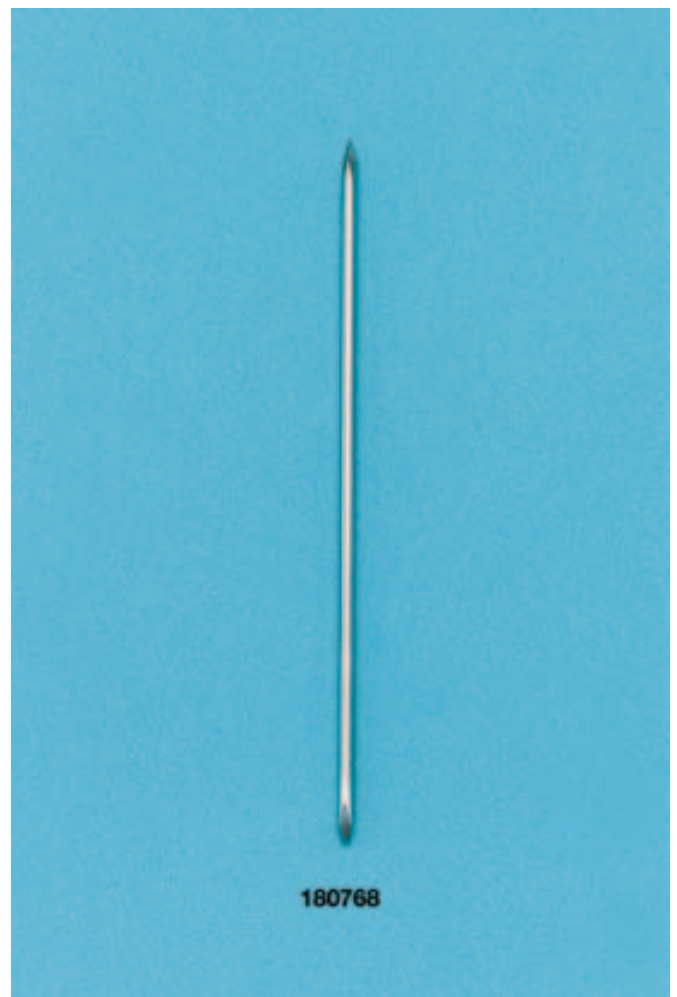
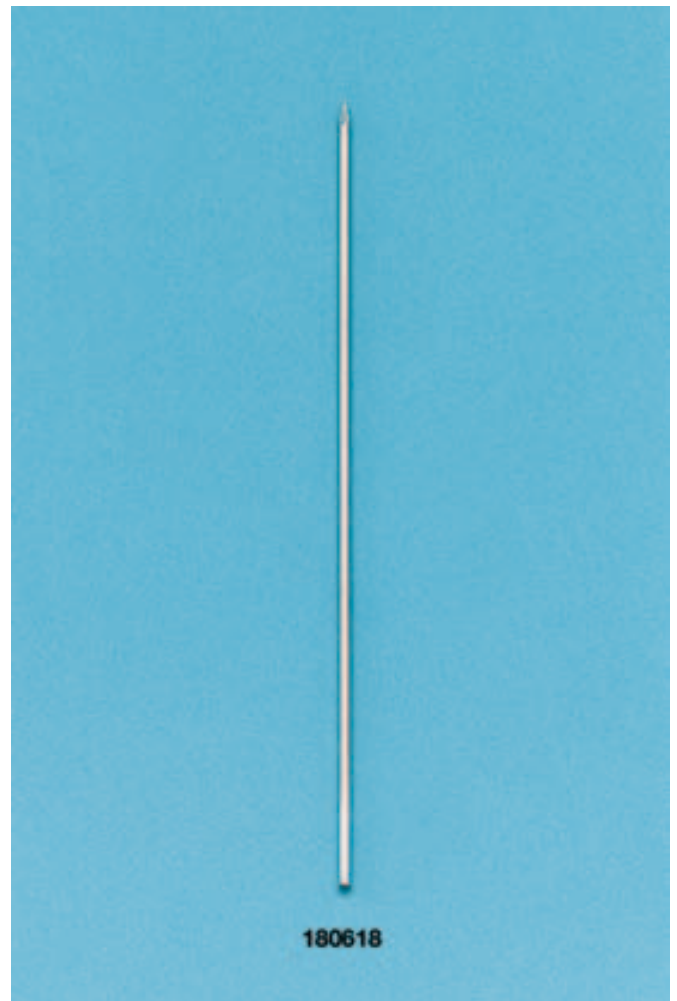

Trocar Pins, Pin Dispenser

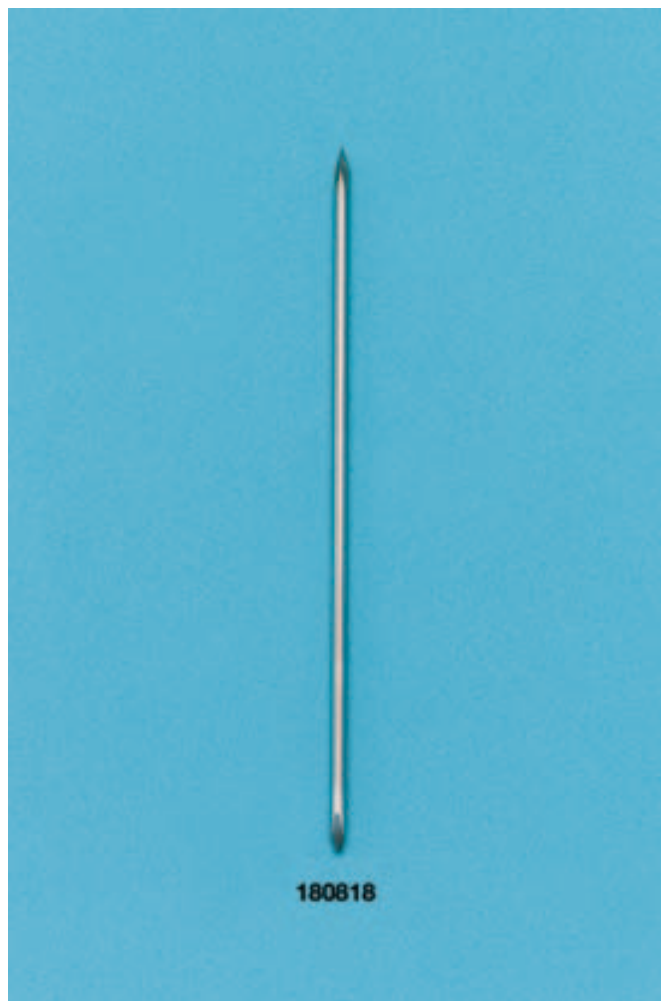

TROCAR PINS

For use with the metric system
- highest quality implant steel
- special long point
- Trocar / Trocar point
- length = 31cm
- 10/box

D = 0.8mm

180808

D = 1.0mm

180810

D = 1.2mm

180812

D = 1.4mm

180814

D = 1.6mm

180816

D = 1.8mm

180818

D = 2.0mm

180820

D = 2.2mm

180822

D = 2.5mm

180825

D = 3.0mm

180830

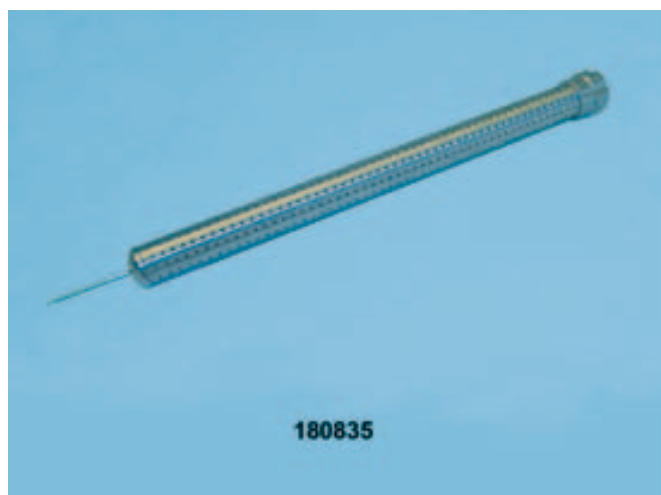

PIN DISPENSER

For 16cm pins, autoclavable

D = 0.8mm

180835

D = 1.0mm

180836

D = 1.2mm

180837

D = 1.4mm

180838

D = 1.6mm

180839

D = 2.0mm

180840

D = 2.2mm

180841

D = 2.5mm

180842

External Fixation Kit, External Fixation Clamps, External Fixation Bars

EXTERNAL FIXATION KIT – FRENCH TYPE

- economically priced kit for fracture treatment
- for small to medium cats and dogs
- easy to use
- reusable

Complete starter Kit with autoclavable bag
180006

contains:

- fixation clamp 1x2mm, 10 pcs
- fixation clamp 2x3mm, 10 pcs
- fixation clamp 2x4mm, 10 pcs
- fixation clamp 3x4mm, 10 pcs
- wrench
- pin, D = 1.0mm, L = 16cm, trocar/trocar, 10 pcs
- pin, D = 2.0mm, L = 16cm, trocar/trocar, 10 pcs
- pin, D = 3.0mm, L = 16cm, trocar/trocar, 10 pcs
- bar, D = 2mm, L = 50cm, 3 pcs
- bar, D = 3mm, L = 50cm, 3 pcs
- bar, D = 4mm, L = 50cm, 3 pcs
- Stainless Steel Gauge for pins D = 0.8mm to D = 3mm

180850

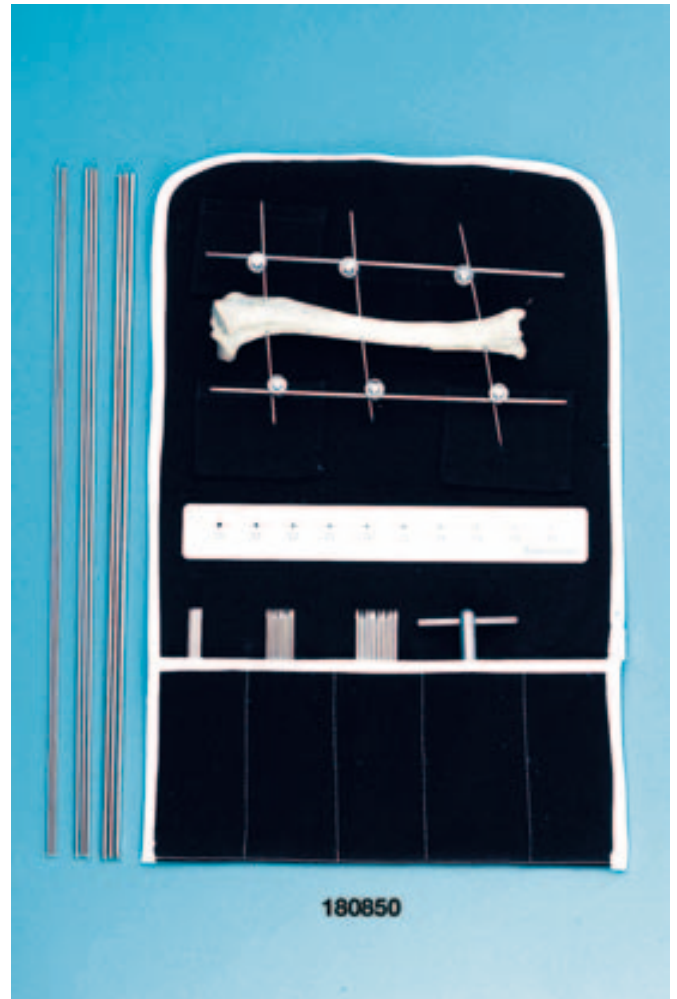

EXTERNAL FIXATION CLAMPS

1x2mm, for cats and small dogs

180852

1.5x3mm, for cats and small dogs

180860

2x3mm, for medium dogs

180853

2x4mm, for medium dogs

180854

3x4mm, for large dogs

180855

Wrench

not illustrated

180856

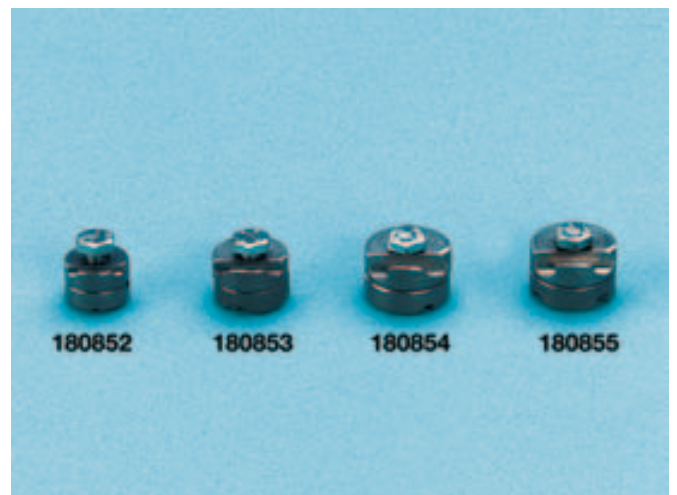

EXTERNAL FIXATION BARS

External fixation bar, D = 2.0mm, L = 50cm

180857

External fixation bar, D = 3.0mm, L = 50cm

180858

External fixation bar, D = 4.0mm, L = 50cm

180859

Stainless Steel Gauge for pins D = 0.8mm to D = 3mm

180844



Interlocking Nail System, Orthopaedic Mallets, Chucks



TITANIUM INTERLOCKING NAIL SYSTEM

D = 3.5mm, consisting of:

- 4x Cortical Screws D = 2.0mm, self tapping, L = 12mm
- 4x Cortical Screws D = 2.0mm, self tapping, L = 14mm
- 1x Interlocking Nail D = 3,5mm, L = 109mm
- 1x Interlocking Nail D = 3,5mm, L = 119mm
- 1x Interlocking Nail D = 3,5mm, L = 130mm
- 1x Screw Driver D = 1.5mm
- 1x Drill D = 1.5mm, L = 105mm
- 1x Drill D = 2.5mm, L = 105mm
- 1x Drill Guide D = 1.5mm
- 1x Drill Guide D = 4.0mm
- 1x Interlocking Nail Guide D = 3.5mm
- 1x Tray

181070

VET Eickemeyer®

Visit us on our website
www.eickemeyer.de



ORTHOPAEDIC MALLETS

HAJEK, L = 22cm, 140g

180482

BERGMANN, L = 24cm, 300g

180484

With lead insert, 180g

174818

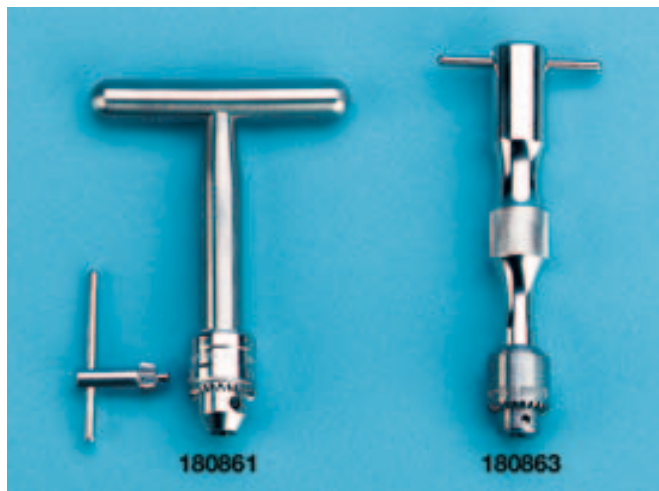

T-HANDLED JACOBS CHUCKS

- to insert bone pins
- fully cannulated
- autoclavable

15cm with key, for pins up to D = 6.35mm

180861

14cm with key, for pins up to D = 4.5mm

180863

ORTHOPAEDIC DRILL

Orthopaedic Drill Kit with extended stainless steel JACOBS chuck, charger, 2 batteries and case

- correct pin insertion with maximum control
- pure axial rotation
- infinitely variable speed
- chuck sterilisable and autoclavable

180866

Autoclavable Drill Cover with Velcro closure

180869

Extended stainless steel JACOBS chuck

- fits on standard cordless drills

180090

Rechargeable Spare Battery for 180866

180870

T-Handle for JACOBS chuck, for small bone fractures

18009001

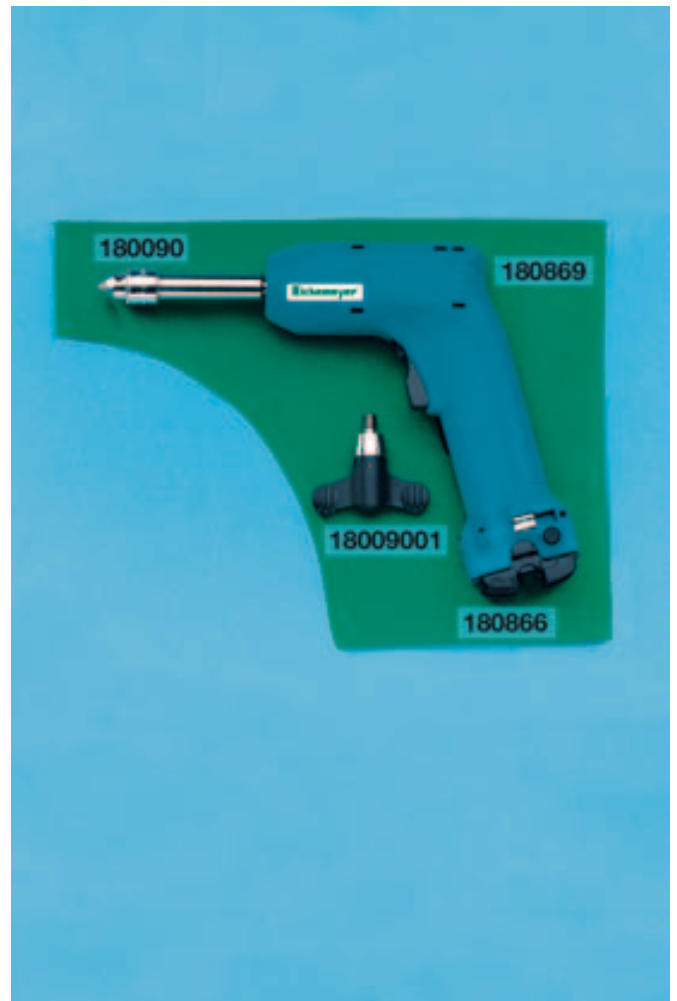

QUICK RELEASE CHUCK

- quick and easy instrument change
- autoclavable
- for drills, screwdrivers, etc
- fits for Square and AO-Shaft

180868



STERILISING CONTAINER

For pins up to 16cm

Sterilising container, 23x13x7cm, filter cloth inlays, stainless steel, with locking clamp

180843

Sterilising rack for pins up to D = 2.0mm, 17x9.2x2.5cm

180845



Sterilising Containers, Implant Cutters, K-Wire Cutter

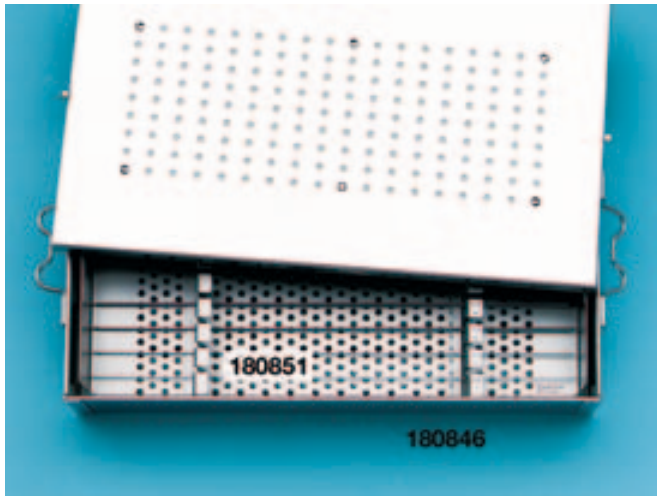

STERILISING CONTAINER

For pins up to 31cm

Sterilising container 34x20x7cm, filter cloth inlays, stainless steel, with locking clamp
180846

Sterilising rack for pins up to
D = 2.5mm, 31.5x19.5x6cm
180851



IMPLANT CUTTERS

- extremely strong
- durable
- with Tungsten Carbide inserts (TC)

21.5cm, for hard wire up to D = 2.2mm
180921

22cm, for soft wire up to D = 3.5mm and hard wire up to D = 2.5mm
180922

Plate and wire cutter up to D = 3.5mm
180924



K-WIRE CUTTER HERCULES

Approved transmission of power. Rubber jaws keep the Pin ends together after cutting

- over 40% less power required
- exchangeable TC-blades and rubber jaws

HERCULES, 23cm, TC
- for pins up to 3mm
180955

HERCULES, 18cm, TC
- for pins up to 2.2mm
180960

Spare Cutting Plates Set for Wire Cutter
180955
18095501

Spare Rubber Inserts Set for Wire Cutter
180955
18095502

Spare Cutting Plates Set for Wire Cutter
180960
18096001

K-WIRE CUTTER

42cm, heavy model, fits autoclave MELAG 23
- for pins up to 6mm
- stainless steel with Tungsten Carbide inserts
180947

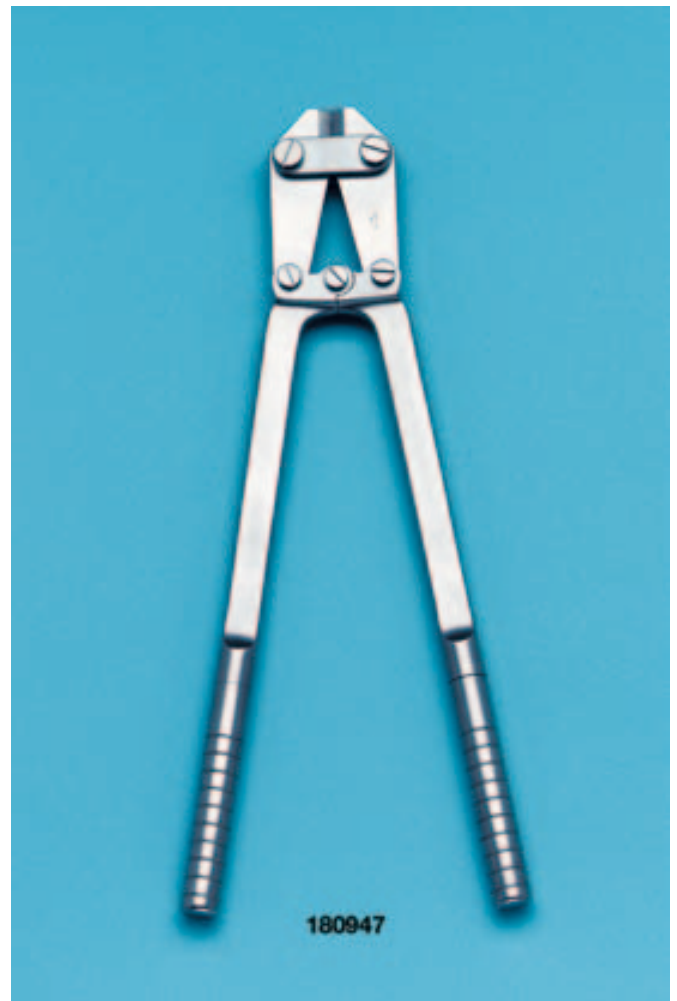

K-WIRE BENDER

For K-wires, 12cm, ID = 2.7mm
181011



WIRE EXTRACTION FORCEPS

For K-wires, 13cm
181213

For K-wires, 18cm
181218



Cerclage Wire Forceps, Cerclage Wire



CERCLAGE WIRE FORCEPS

These forceps guarantee a safe and easy tensioning of all sizes of cerclage wire

Wire tightener, 15cm, TC

Specially designed for tension band wiring and to bend pins to minimise Backing

181315

Wire cutting and bending pliers, 16cm

181316



PARALLEL ACTION PLIERS

18.5cm

- for bending and holding

- industrial finish

- will autoclave with optical deterioration

- lubricate well prior to autoclaving

181318



CERCLAGE WIRE

- highest quality implant steel

- length = 10m

- soft bone wire

D = 0.2mm

181402

D = 0.4mm

181404

D = 0.6mm

181406

D = 0.8mm for animals up to 15kg

181408

D = 1.0mm for animals up to 40kg

181410

D = 1.2mm for animals more than 40kg

181412

D = 1.5mm

181415

Wire Cutters, Orthopaedic Wire Twister, Graft Passers, Cerclage Wire Passer

WIRE CUTTERS

- curved cutting edges with notch
- serrated
- for soft cerclage wire

12cm, with Tungsten Carbide inserts

181012

12cm

181112



ORTHOPAEDIC WIRE TWISTER LOUTE

Loute wire twister

- fits all diameter cerclage wire
- easy tightening
- automatic wire cut
- 22cm length

181622



GRAFT PASSER SCHAWALDER

Specially designed instrument for cranial crucial ligament surgery
Particularly suitable for large dogs

Head diameter = 5cm, L = 18cm

181505

Head diameter = 6cm, L = 20cm

181506



CERCLAGE WIRE PASSER / INTRODUCER SET

Wire Passer, head diameter 2.5cm, L = 21cm

181521

SISMEY'S Wire Introducer

Set of wire passing and suture passing needles for different-sized bones

- handle, double ended (181551)
- 6 suture needles, large (181556 and 181566)
- 3 wire passers, small, medium, large

181550

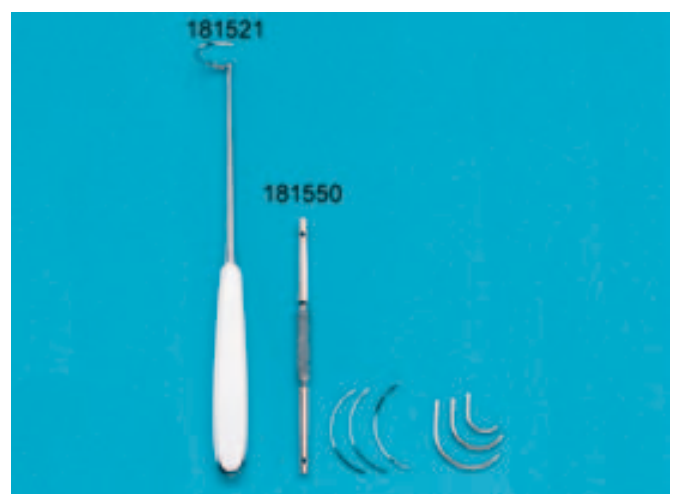

Graft Passers, CCL Staple Instrument



CURVED GRAFT PASSER

For the repair of the cranial crucial ligament by the, over-the-top' technique
- to pull the graft through the stiffler joint

Head diameter 2.0cm, L = 15.5cm

181520

Head diameter 3.0cm, L = 16.5cm

181530

Head diameter 4.5cm, L = 17.5cm

181545

Head diameter 6.0cm, L = 20.5cm

181560

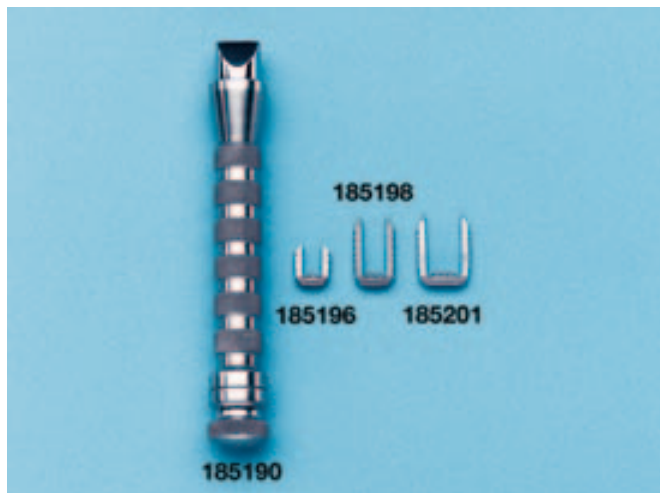

CCL STAPLE INSTRUMENT

For the fixation of the fascia lata graft to the distal femur, 3 different staple sizes

CCL Staple introducer

185190

CCL Staple, L = 15mm, W = 6mm

185196

CCL Staple, L = 23mm, W = 8mm

185198

CCL Staple, L = 23mm, W = 11mm

185201

VET Eickemeyer®

Medizintechnik für Tierärzte

Our family run business has earned a worldwide reputation for the supply of state-of-the-art veterinary equipment. For nearly 50 years Eickemeyer have become experts not just in the science of veterinary medicine, but also in how to build and grow a successful practice. We have always sought to supply the finest instruments and equipment available and where we can't find a product which meets our exacting quality criteria, we design and make our own. We take the time to listen to your needs and to find solutions to the challenges of modern veterinary medicine. After all, your success is our success.



Eickemeyer Headoffice in Tuttlingen, Germany



Eickemeyer Logistic Centre in Tuttlingen, Germany

CRANIAL CRUCIAL LIGAMENT SUTURE SYSTEM

This system helps to make an enduring fixation of the cranial crucial ligament easily and without the help of an assistant

- crimp tubes instead of a large knots
- enduring stretching by strong crimp tubes
- successfully established worldwide

Set of 1 crimp tube 10mm and Nylon 50cm
- for animals up to 10kg, sterile packed
19409501

Set of 1 crimp tube 12mm and Nylon 80cm
- for animals up to 20kg, sterile packed
19409601

Set of 1 crimp tube 12mm and Nylon 80cm
- for animals more then , sterile packed
19409701

Set of 3 crimp tubes 10mm and Nylon 50cm
- for animals up to 10kg, sterile packed
194095

Set of 3 crimp tubes 12mm and Nylon 80cm
- for animals up to 20kg, sterile packed
194096

Set of 3 crimp tubes 12mm and Nylon 80cm
- for animals more , sterile packed
194097

Nylon, 50lb, L = 50cm, sterile packed
194062

Nylon, 80lb, L = 80cm, sterile packed
194066

Nylon, 100lb, L = 80cm, sterile packed
194070

10mm crimp tube, 10/box, sterile packed
194060

12mm crimp tube, 10/box, sterile packed
194058

Crimping Forceps
not illustrated
194090

Fabella Needle, small, 6/box
not illustrated
194074

Fabella Needle, medium, 6/box
not illustrated
194076

Fabella Needle, large, 6/box
not illustrated
194078

KNEE RETRACTOR WALLACE

Length = 10cm

- allows gentle retraction between tibia and femur
- visualisation of the entire stifle joint

161710

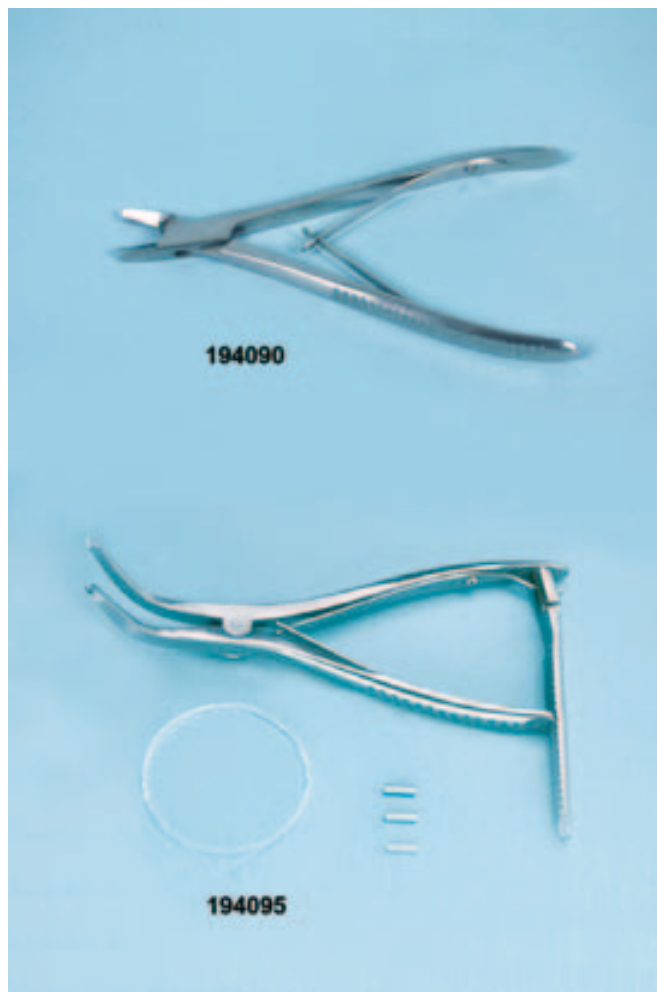

Knee Retractors, Fixing Arm, Bone Rasps

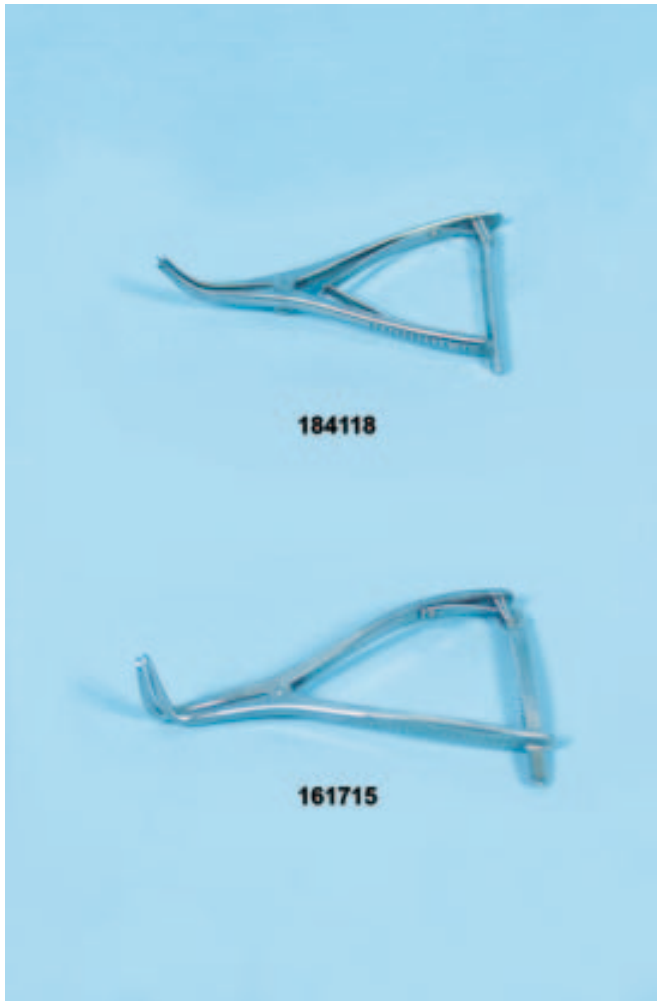

KNEE RETRACTOR INGE MODIFIED ACC. TO MEUTSTEGE

Knee Retractor, 17cm

- designed to open the stifle joint
- easy to use especially on small dogs
- ratchet lock allows the stifle to be locked open
- very delicate tips

184117

Knee Retractor, with additional slits for tightening the cranial crucial ligament

- the well-known osteotome retractor with an additional function
- the cranial crucial ligament can be fixed in a shorter time and without assistance

184118

Knee Retractor, for small joints, 8mm

- perfect for opening small incisions, as well as meniscus operations either lateral or collateral
- very delicate

164115



FIXING ARM

For easy and comfortable restraint of the extremities, during surgery, X-Ray or arthroscopy

- to locate in nearly every position
- quick fixation because of Velcro closure
- can also be used to hold endoscopes

603850



BONE RASPS

Trochlea Rasp, round, 17cm

- for deepening the trochlea groove in patella luxation
- wide range of diameters

182117

Bone rasp, 24cm, large

182124

Molar Rasp, 18cm, delicate

177318

BONE SAWS

Adjustable Bone Saw with 5 blades, 15 to 19cm

182315

Spare blades, 5/pkg.

182317

LINDEMANN, 20cm

182320

LANGENBECK, 23cm

182323

Sterile Saw Blades for STANDARD Scalpel

Handle No. 3, 10/box

182329



BONE SAW

With interchangeable saw blade, L = 16.5cm

- stepless adjustment of the saw blade

- corrugated handle guarantees a safe grip

182310

Saw blade for bone saw, L = 13cm

182311

Saw blade for bone saw, coarse, L = 13cm

182312

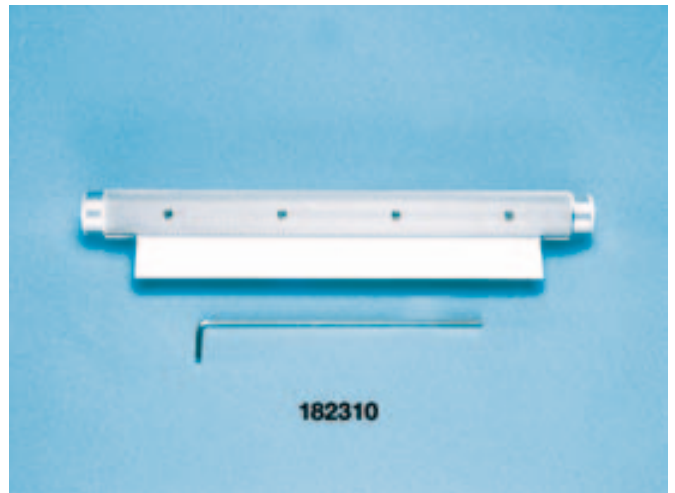

GIGLI WIRE SAW

Also works well for femoral head excision in larger dogs

Saw handle, rotational

182331

Saw wire GIGLI, 30cm

182332

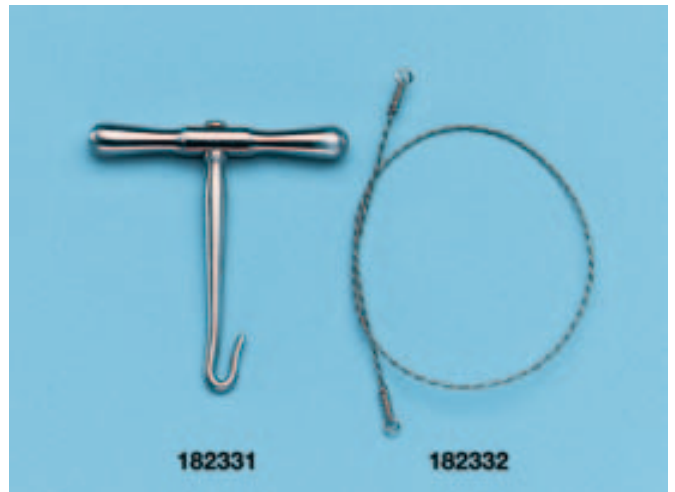

OSTEOTOME LAMBOTTE

L = 25cm, W = 8mm

182408

L = 25cm, W = 10mm

182410

L = 25cm, W = 15mm

182415

L = 25cm, W = 20mm

182420

L = 12.5cm, W = 4mm

182454

L = 12.5cm, W = 6mm

182456

L = 12.5cm, W = 8mm

182458

L = 12.5cm, W = 10mm

182460

L = 12.5cm, W = 15mm

182465

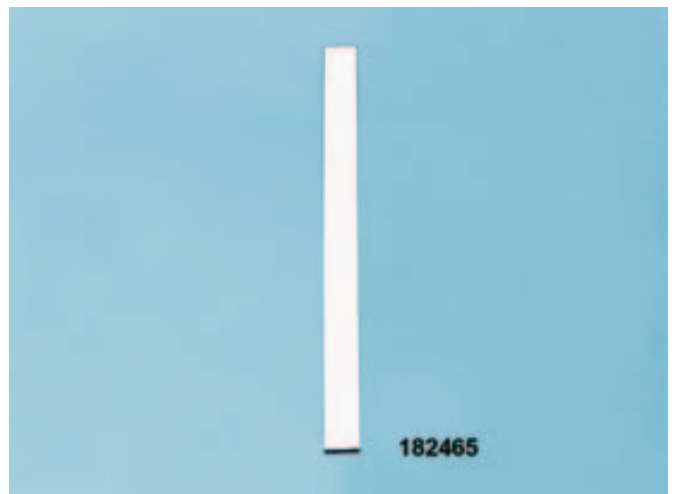

Osteotomes, Bone Retractors, Retractors, Fragment Forceps

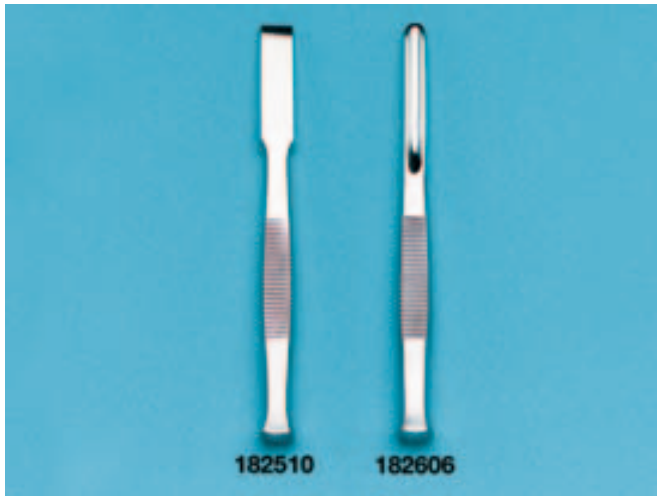

CHISEL AND GAUGES

Chisel, 14cm, width = 10mm

182510

Gauge, 14cm, width = 6mm

182606

Gauge, 14cm, width = 10mm

182610



BONE RETRACTORS

L = 15cm, W = 6mm

182705

L = 16cm, W = 8mm

182708

HOHMANN, L = 22cm, W = 10mm, for knee surgery

182710

HOHMANN, L = 27cm, W = 13mm

not illustrated

182713

Femoral head disarticulator, L = 14cm, with blade to cut the ligamentum teres

182714

HOHMANN, L = 24cm, W = 17mm

182717



RETRACTOR MEYERDING

- ideal for hip surgery

Length = 21cm, width = 50x16mm

182724

Length = 23cm, width = 75x25mm

182725



FRAGMENT FORCEPS

Length = 13.5cm

not illustrated

182813

Length = 17cm

182817

Length = 20cm

182820

Length = 14cm, with closing tips

182914

BONE HOLDING FORCEPS

With central insert for bone screws, angled jaw,
15cm
183016



BONE HOLDING FORCEPS

With ratchet and serrated jaws,
for cats and midsize dogs, 13.5cm
183014

With central insert for bone screws, 15cm
183015

SETTER Reduction Forceps, 16cm
- with serrated jaws and spin lock
183017

SETTER Reduction Forceps, 24cm
- with serrated jaws and spin lock
183020



BONE HOLDING FORCEPS

KERN-MINI, with ratchet, 17cm
183117

KERN, with ratchet, 21cm
183121

KERN-MINI, modified for small bones, with
ratchet, 17cm
183527

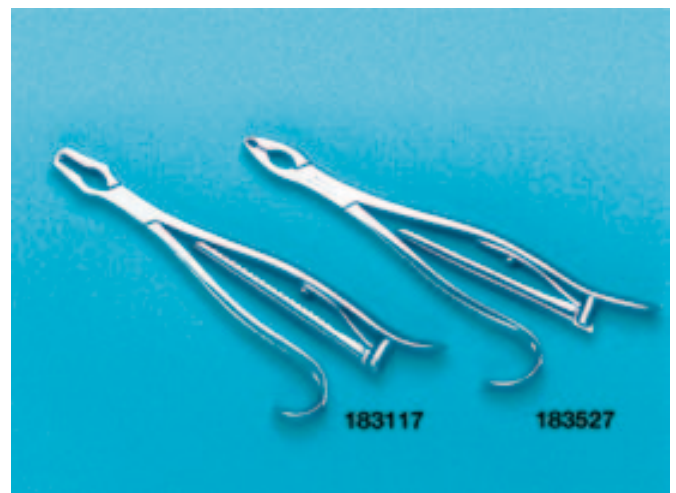

BONE HOLDING AND BONE CUTTING FORCEPS

Self-Centering Bone Holding Forceps, with spin
lock, 15cm
183415

Self-Centering Bone Holding Forceps, with spin
lock, 19cm
183419

LISTER Bone Cutting Forceps, straight, 17cm
183617



Rongeurs, Bone Laminectomy Forceps, Laminectomy Rongeurs, Meniscal Instruments



RONGEURS

LUER-FRIEDMANN, curved, 14cm
184114

LUER, curved, 14cm
184115

BOEHLER, straight, compound action, 15cm
184215

BOEHLER, curved, compound action, 15cm
184315



BONE AND LAMINECTOMY RONGEURS

Rongeur BEYER, curved, compound action, 18cm
184318

SCHNEIDEMANN Laminectomy Forceps, 15cm, laterally curved, compound action, very delicate
184414

SCHNEIDEMANN Laminectomy Forceps, 15cm, laterally curved, compound action
184415

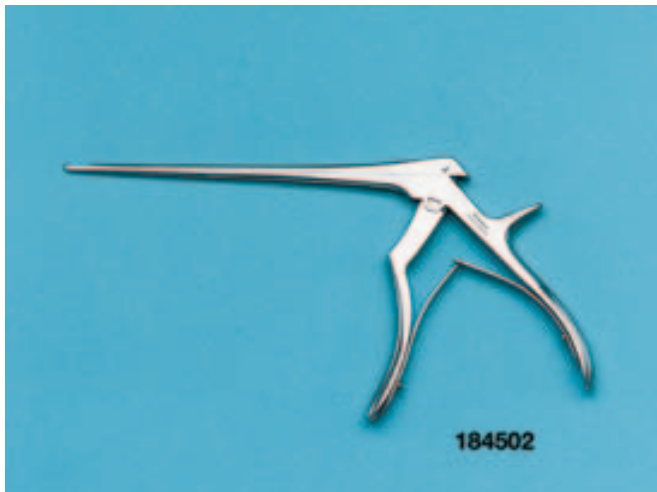

LAMINECTOMY RONGEURS FERRIS-SMITH-KERRISON

Traditional design in top-level quality

2mm shank, 18cm, 40° upward cutting jaw
184502

3mm shank, 18cm, 40° upward cutting jaw
184503



MENISCAL INSTRUMENTS

PRIEUR-SUMNER-SMITH pattern
Very efficient use of the limited space within the canine stifle

Meniscus Forceps, 13cm
184813

Meniscus Knife, 17cm
184817

BONE BIOPSY NEEDLE

With mandrin, for taking bone marrow samples

ID = 2.0mm, OD = 3.0mm, L = 17cm

184903

ID = 3.0mm, OD = 5.0mm, L = 17cm

184905



MINI BONE PLATES

- for screws with 1.5 and 2.0mm diameter

- width = 5.0mm

- thickness = 1.0mm

4-holes, length = 22mm (AESCULAP)

187604

5-holes, length = 27mm (AESCULAP)

187605

6-holes, length = 32mm (AESCULAP)

187606

7-holes, length = 37 mm (AESCULAP)

187607

8-holes, length = 42mm (AESCULAP)

187608

4 holes, length = 22mm (EICKEMEYER)

98187604

5 holes, length = 27mm (EICKEMEYER)

98187605

6 holes, length = 32mm (EICKEMEYER)

98187606

7 holes, length = 37mm (EICKEMEYER)

98187607

8 holes, length = 42mm (EICKEMEYER)

98187608

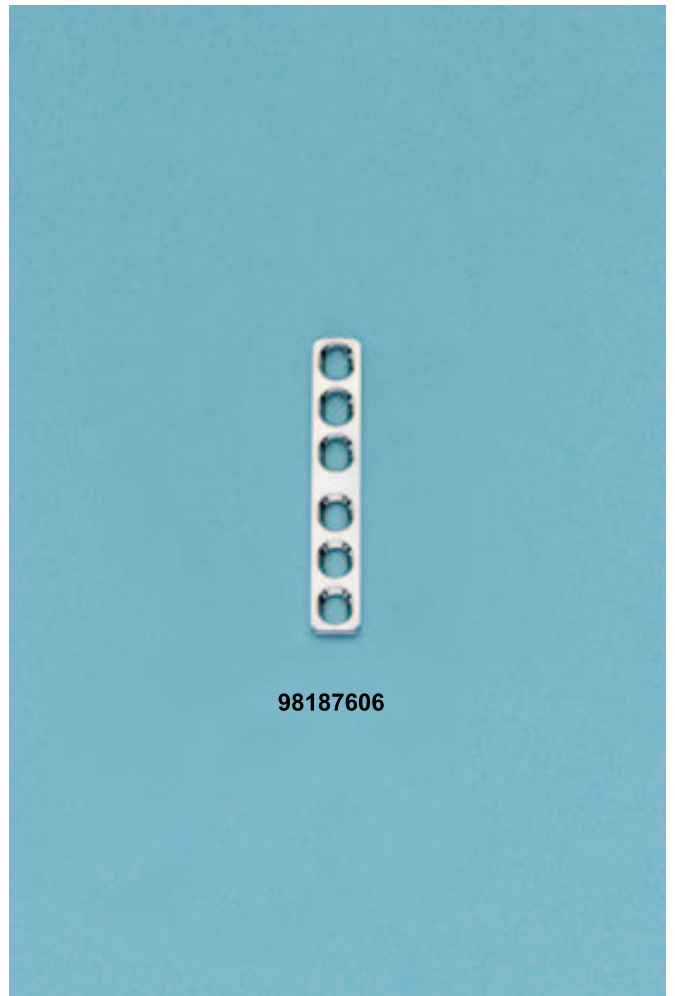

Mini Compression Plates

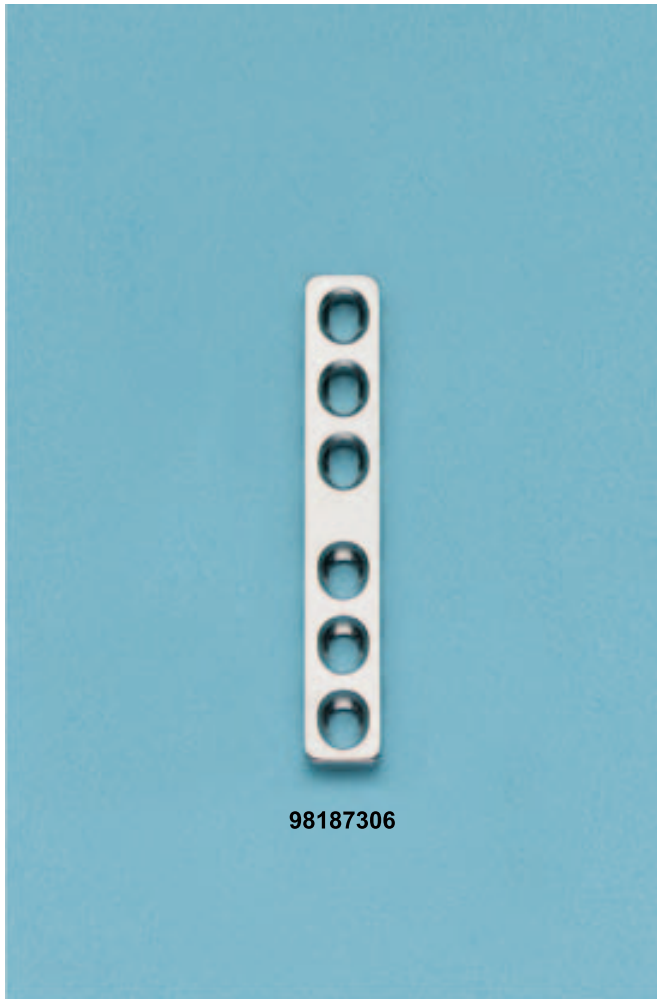

98187306

MINI COMPRESSION PLATES

- for screws with 2.0mm diameter
- width = 5.0mm
- thickness = 2.0mm

2 holes, length = 12mm (EICKEMEYER)

98187302

4 holes, length = 22mm (EICKEMEYER)

98187304

6 holes, length = 32mm (EICKEMEYER)

98187306

8 holes, length = 42mm (EICKEMEYER)

98187308

10 holes, length = 52mm (EICKEMEYER)

98187310



98187324

MINI COMPRESSION PLATES

- for screws with 2.7mm diameter
- width = 8.0mm
- thickness 2.6mm

14 holes, length = 112mm

187324



98187505

MINI COMPRESSION T-PLATE

- for screws with 1.5 and 2.0mm diameter
- width = head = 12.0mm / shaft = 5.0mm
- thickness = 1.0mm

4 holes, length = 18mm

187505

4-holes, T-shaped, length = 18mm, for screws with D = 1.5 and 2.0mm (EICKEMEYER)

98187505

MINI FRAGMENT PLATES

- with round holes
- curved profile
- for screws with 2.7mm diameter
- width = 7.0mm
- thickness = 1.0mm

2-holes, length = 17mm (AESCULAP)
187702

3 holes, length = 25mm (AESCULAP)
187703

4 holes, length = 33mm (AESCULAP)
187704

6 holes, length = 49mm (AESCULAP)
187706

8 holes, length = 65mm (AESCULAP)
187708

10 holes, length = 81mm (AESCULAP)
187710

3-holes, length = 25mm (EICKEMEYER)
98187703

4-holes, length = 33mm (EICKEMEYER)
98187704

8-holes, length = 65mm (EICKEMEYER)
98187708

6-holes, length = 49mm (EICKEMEYER)
98187706

10-holes, length = 81mm, (EICKEMEYER)
98187710

COMPRESSION PLATES / LC-DCP PLATES

- low contact (LC)
- for screws with 2.7mm diameter
- width = 8.0mm
- thickness = 2.5mm

4-holes, length = 36mm
98187614

6-holes, length = 52mm
98187616

8-holes, length = 64mm
98187618

10-holes, length = 80mm
98187620

12-holes, length = 96mm
98187622

14-holes, length = 112mm
98187624

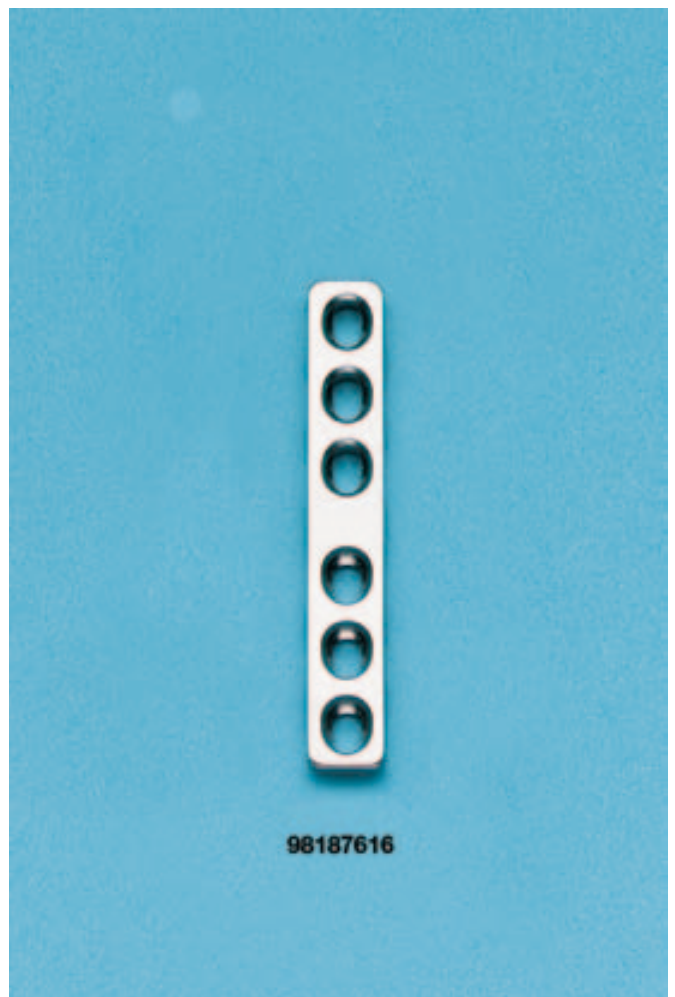
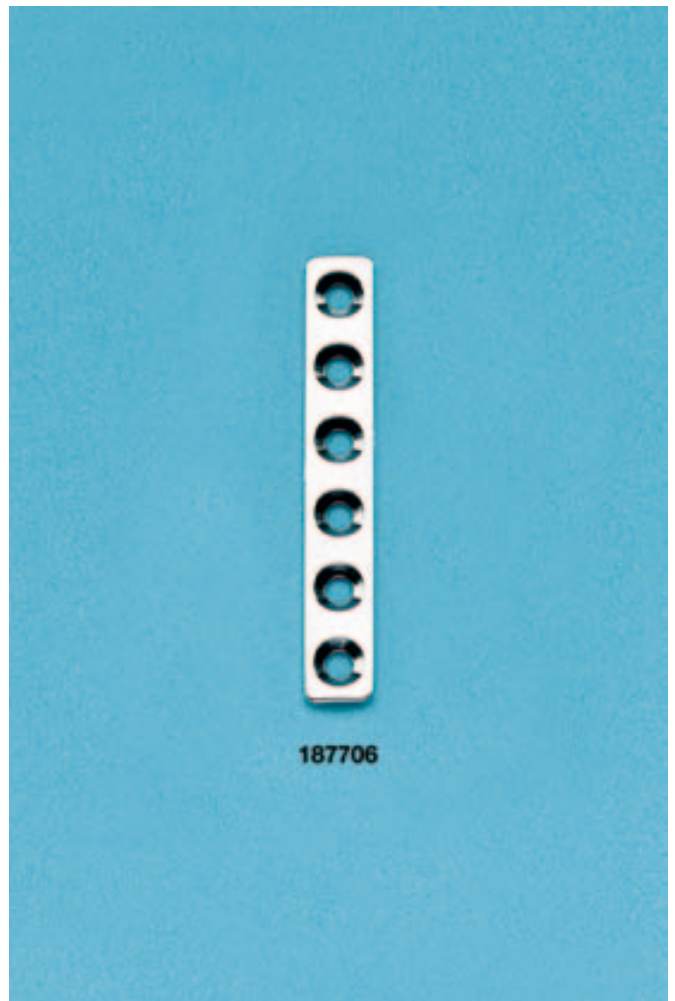

Extension Plates, Compression Plates



98187377

EXTENSION PLATES

- for screws with 2.7mm diameter
- width = 8.0mm
- thickness = 2.5mm

7 holes, length = 70mm

98187377

8 holes, length = 80mm

98187378

7 holes, length = 80mm

98187387

8 holes, length = 90mm

98187388

7-holes, length = 90mm

98187397

8-holes, length = 100mm

98187398

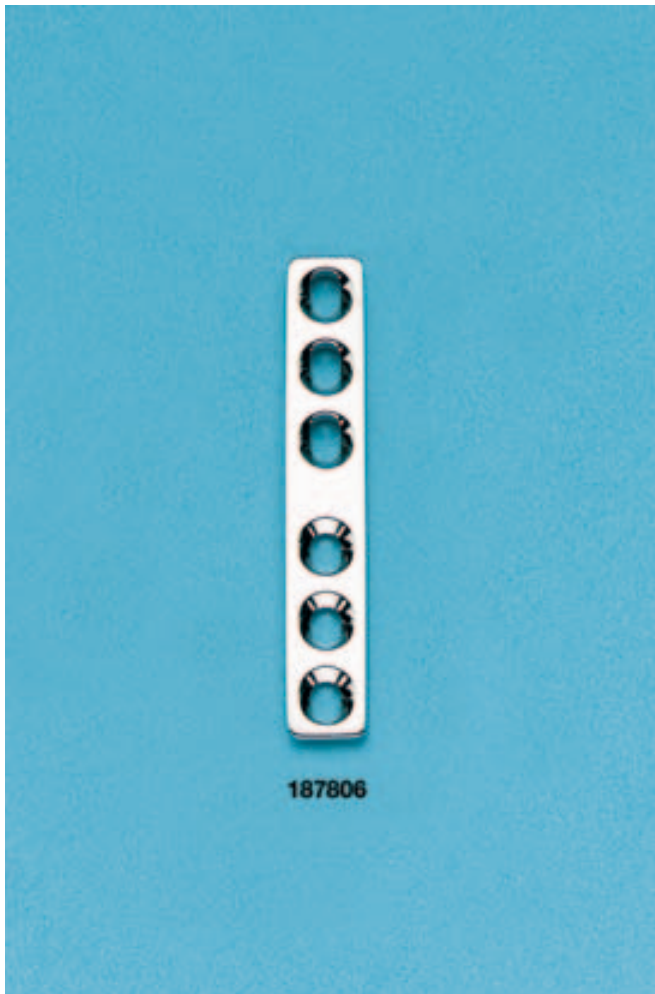

187806

COMPRESSION PLATES

- for screws with 2.7mm diameter
- width = 8.0mm
- thickness = 2.0mm

4-holes, length = 36mm (AESCULAP)

187804

5-holes, length = 44mm (AESCULAP)

187805

6-holes, length = 52mm (AESCULAP)

187806

7-holes, length = 60mm (AESCULAP)

187807

8-holes, length = 68mm (AESCULAP)

187808

9 holes, length = 76mm

187809

10 holes, length = 84mm

187810

12 holes, length = 100mm

187812

4 holes, length = 36mm

98187804

5 holes, length = 44mm

98187805

6 holes, length = 52mm

98187806

7 holes, length = 60mm

98187807

8 holes, length = 68mm

98187808

9-holes, length = 76mm, (EICKEMEYER)

98187809

10-holes, length = 84mm, (EICKEMEYER)

98187810

12-holes, length = 100mm, (EICKEMEYER)

98187812

MINI FRAGMENT T-PLATE

- round holes
- for screws with 2.7mm diameter
- width = 7.0mm
- thickness = 1.0mm

5-holes, length = 32mm, (AESCULAP)
187905

5 holes, length = 32mm, (EICKEMEYER)
98187905

COMPRESSION T-PLATES

- thickness = 1.5mm

4 holes, length = 35mm, width: 5.0mm,
for screws with 2.0mm diameter
98187514

5 holes, length = 36mm, width = 5.0mm,
for screws with 2.0mm diameter
98187515

6 holes, length = 52mm, width = 8.0mm,
for screws with 2.0mm diameter
98187516

4 holes, length = 60mm, for screws with 2.7mm
+ 3.5mm diam.
98187524

6 holes, length = 60mm, for screws with 2.7mm
+ 3.5mm diam.
98187536

heavy duty, 10 holes, length = 135mm,
for screws with 3.5mm diam.
98187540



98187905



98187514

VET Eickemeyer®

Quality products
for the veterinary profession
since 1961

Compression Plates, Broad Compression Plates

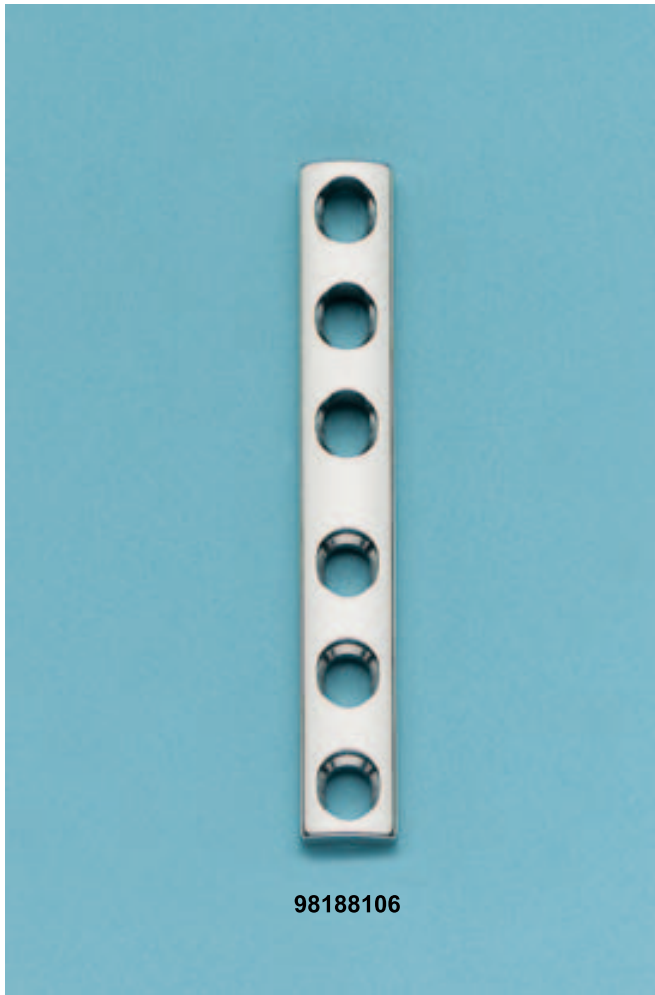

98188106

COMPRESSION PLATES

- curved profile
- for screws with 3.5 and 4.0mm diameter
- width = 10.0mm
- thickness = 3.0mm

4 holes, length = 50mm (AESCULAP)

188104

5 holes, length = 62mm (AESCULAP)

188105

6 holes, length = 74mm (AESCULAP)

188106

7 holes, length = 86mm (AESCULAP)

188107

8 holes, length = 98mm (AESCULAP)

188108

10 holes, length = 122mm (AESCULAP)

188110

12 holes, length = 146mm (AESCULAP)

188112

4 holes, length = 50.0mm

98188104

5 holes, length = 62.0mm

98188105

6 holes, length = 74.0mm

98188106

7 holes, length = 86.0mm

98188107

8 holes, length = 98.0mm

98188108

10 holes, length = 122.0mm

98188110

12 holes, length = 146.0mm

98188112

BROAD COMPRESSION PLATES

- for screws with 3.5 and 4.0mm diameter
- width = 10.0mm
- thickness = 3.6mm

9 holes, length = 110mm

98188159

10 holes, length = 122mm

98188160

11 holes, length = 134mm

98188161

12 holes, length = 146mm

98188162

13 holes, length = 158mm

98188163

14 holes, length = 170mm

98188164

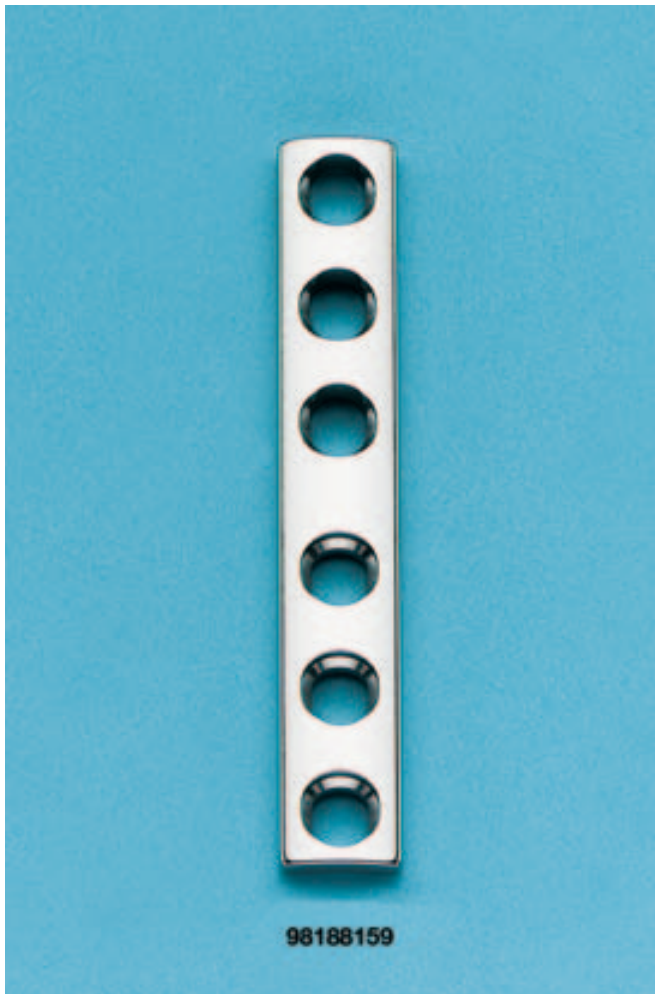

98188159

Broad Compression Plates, Cuttable Plates, Broad Extension Plates

COMPRESSION PLATES

- for screws with 4.5mm diameter

- width = 12.0mm

- thickness = 4.0mm

4 holes, length = 71mm (AESCULAP)

188204

5 holes, length = 87mm

188205

6 holes, length = 103mm

188206

7 holes, length = 119mm (AESCULAP)

188207

8 holes, length = 135mm (AESCULAP)

188208

9 holes, length = 151mm (AESCULAP)

188209

10 holes, length = 167mm (AESCULAP)

188210

11 holes, length = 183mm (AESCULAP)

188211

12 holes, length = 199mm (AESCULAP)

188212

4 holes, length = 71mm

98188204

5 holes, length = 87mm (EICKEMEYER)

98188205

6-holes, length = 103mm (EICKEMEYER)

98188206

7 holes, length = 119mm

98188207

8 holes, length = 135mm

98188208

9 holes, length = 151mm

98188209

10 holes, length = 167mm

98188210

11 holes, length = 183mm

98188211

12 holes, length = 199mm

98188212

CUTTABLE PLATES

Width: 7mm

For screws with 2.0mm diameter,

length: 300mm, thickness: 1.2mm

98188320

For screws with 2.7mm diameter,

length = 300mm, thickness = 1.5mm

98188327

EXTENSION PLATES

- Extension: 30mm

- for screws with 4.5 and 6.5mm diameter

- width = 1.6mm

- thickness = 5.0mm

8-holes, length = 135mm, (AESCULAP)

188408

8 holes, length = 135mm (EICKEMEYER)

98188408

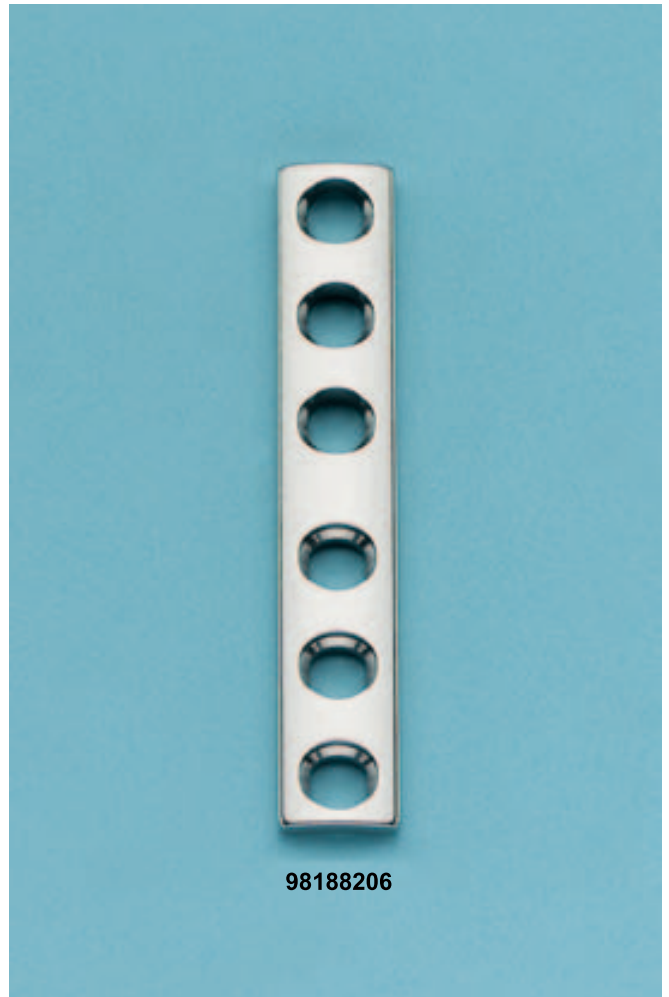

Reconstruction Plates, Acetabular Plates

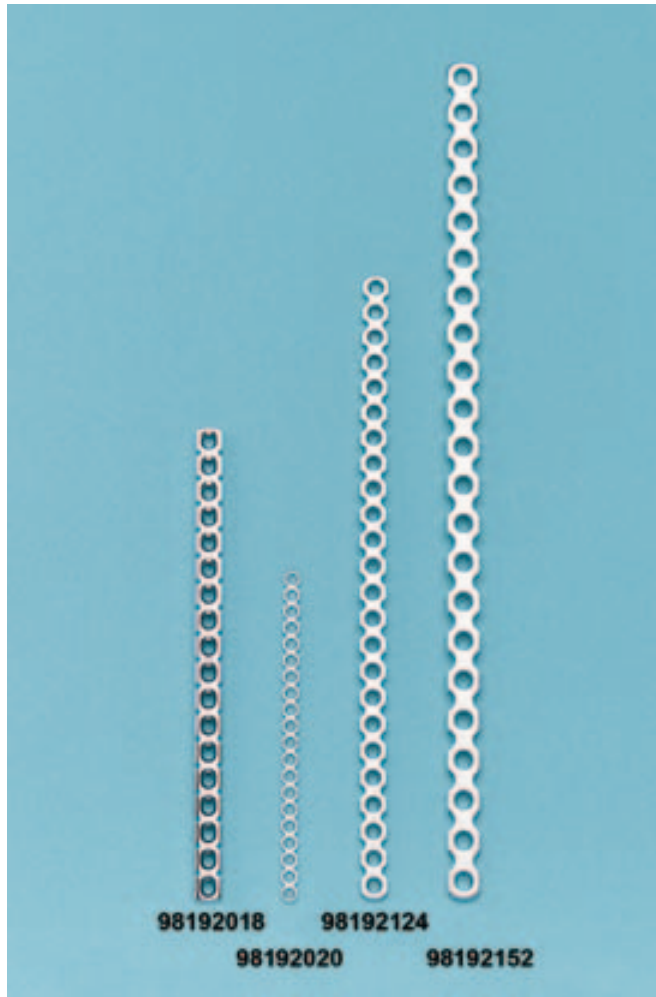

RECONSTRUCTION PLATES

Designed for easy contouring

18 holes, length = 144mm, for screws with 2.7mm diameter, width = 8.0mm, thickness: 3.0mm

98192018

24 holes, length = 192mm, for screws with 2.7mm diameter, width = 7.5mm, thickness: 2.5mm

98192124

20 holes, length = 100mm, for screws with 2.0mm diameter, width = 5.0mm, thickness: 1.0mm

98192020

22 holes, length = 262mm, for screws with 3.5mm diameter, width = 9.5mm, thickness: 2.0mm

98192152



ACETABULAR PLATES

Length = 31mm

6 holes, for screws with 1.5mm diameter, width = 5mm, thickness = 1.5mm

98192304

4 holes, for screws with 2.7 and 3.5mm diameter, width = 8mm, thickness = 2.0mm

98192308

6 holes, for screws with 2.7 and 3.5mm diameter, width = 8mm, thickness = 2.0mm

98192309

TPLO SAW BLADES

Fits on all standard Oscillating Saws

TPLO Saw Blade R = 18mm

192909

TPLO Saw Blade R = 22.5mm

192910

TPLO Saw Blade R = 30.0mm

192911



192910

TPLO JIG

Aluminium blue anodized

- to maintain bone alignment during TPLO

- TPLO jig arms permits flexibility for different breeds

192915

TPLO Rotation Gauge Pack with 10 pcs

192981



192915

TPLO SAW BLADE

- fits to OrthoVet and ELAN Vet

Macro flexible cable, 160cm

(210cm upon request)

195025

Macro Line transversal saw, w/o blades for TPLO sawblades

delivery without sawblades

195026



195025

195026

OSTEOTOMY GAUGE SET FOR TPLO

Simplifies the marking and cutting of the appropriate wedge, proximally and distally

Set 9 to 22

192980



192980

TPLO Plates, Pancarpal Arthrodesis Plates, Pantarsal Plates

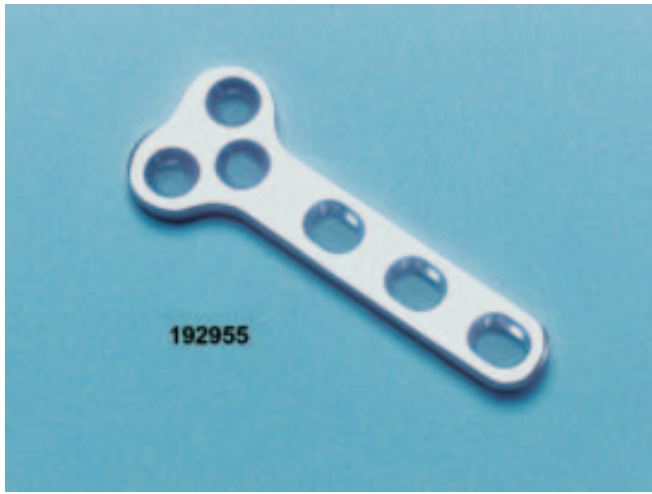

TPLO-PLATES

- especially for tibia plateau levelling operation
- shaft with gliding holes for 3.5mm screws
- head with round holes for 3.5mm and 4.0mm screws
- degenerative joint disease changes are minimal

Length = 39mm

192939

Length = 55mm

192955

Length = 77mm

192977



PANCARPAL ARTHRODESIS PLATES

2.0/2.7mm, self compressing, length = 73mm

98193110

2.0/2.7mm, with round holes, length = 75mm

98193112

2.7/3.5mm, self compressing, length = 100mm

98193120

2.7/3.5mm, with round holes, length = 102mm

98193122

3.5/3.5mm, self compressing, length = 140mm

98193130

3.5/3.5mm, with round holes, length = 140mm

98193132



PANTARSAL PLATES

2.7/3.5mm Pantarsal Plate, right

192800

2.7/3.5mm Pantarsal Plate, left

192801

FEMUR CONDYLAR PLATES

For cats, 44mm, right, length: 40mm
- for screws with 2.0mm diameter

98190796

For cats, 44mm, left, length: 40mm
- for screws with 2.0mm diameter

98190797

For dogs, right, length: 110mm
- for screws with 3.5mm diameter

98190798

For dogs, left, length: 110mm
- for screws with 3.5mm diameter

98190799



Visit our Online-Shop
www.eickemeyer.de

TPO-PLATES

For screws with 3.5mm diameter

TPO-Plate, small

192983

TPO-Plate, large

192982

TPO-Plate, small, 30° left, curved

192986

TPO-Plate, small, 30° right, curved

192987

TPO-Plate, large, 30° left, curved

192984

TPO-Plate, large, 30° right, curved

192985



Y-PLATES

Y-Plate large, left for screws with
2.7mm up to 4.5mm

192990

Y-Plate large, right for screws with
2.7mm up to 4.5mm

192991

Y-Plate medium, left for screws with
2.7mm up to 4.5mm

192992

Y-Plate medium, right for screws with
2.7mm up to 4.5mm

192993

Y-Plate small, left for screws with
2.0mm up to 3.0mm

192994

Y-Plate small, right for screws with
2.0mm up to 3.0mm

192995



Plate Bending Forceps, Bone Plate Benders, Depth Gauges

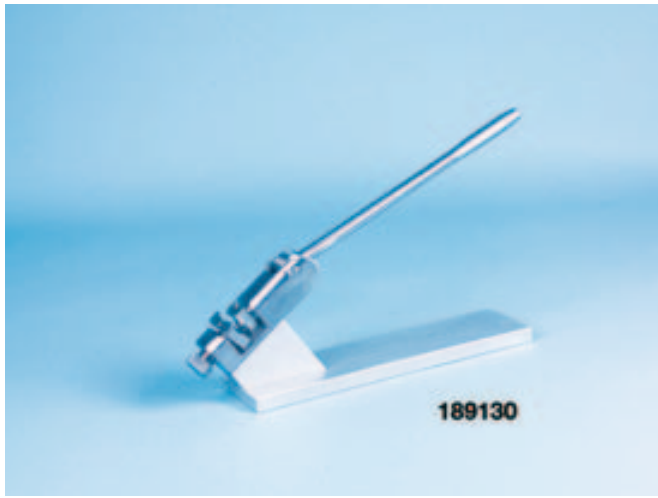

BONE PLATE BENDING PRESS

For easy and safe bending of bone plates,
For screws with diameter 2.7mm, 3.5mm and
4.5mm

- fits into MELAG autoclave

189130



PLATE BENDING FORCEPS

Plate bending forceps for 2.7 / 3.5mm plates
not illustrated

189135

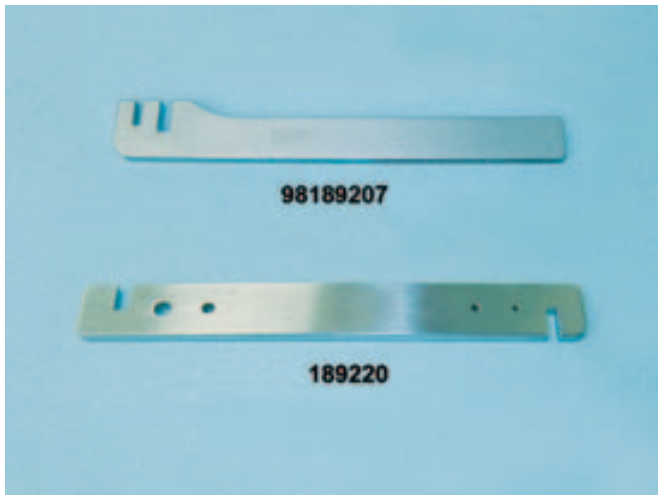

BONE PLATE BENDING IRON

For small bone plates

for plates with D = 3.5 and 2.7mm

98189206

for plates with D = 2.7mm and 3.5mm

not illustrated

98189207

- length = 20cm

- for 3.5mm bone plates

189220

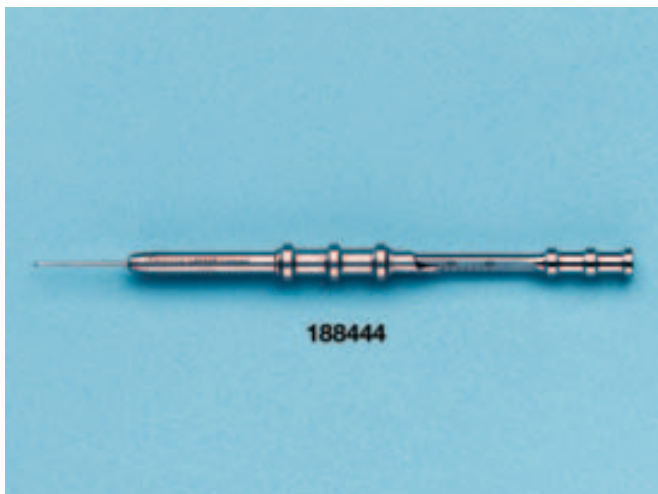

DEPTH GAUGES

Accurate measurement of hole depth

Range = 6–24mm, length = 14cm

188442

Range = 6–40mm, length = 15cm

188444

Range = 10–60mm, length = 22cm

188447

6 - 26mm, 15cm (EICKEMEYER)

not illustrated

98188442

6 - 40mm, 15cm (EICKEMEYER)

not illustrated

98188444

QUICK RELEASE TAP HANDLES

- specially designed for delicate procedures
- allows fingertip control

T-Bar Tap Handle for instruments with 4 square fit (Aesculap)

188605

Tap Handle for instruments with dental fit (Aesculap)

188607

with 4 square shaft (EICKEMEYER)

98188605

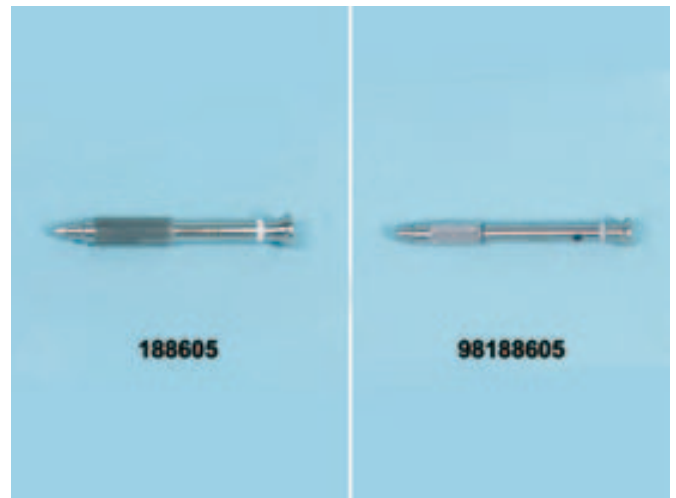

DRILL GUIDE / SLEEVES

Drill guide for Drills with D = 1.1 and 1.5mm

188811

Load /neutral guides for drills with D = 2.0mm, 3/1 holes

188820

Load /neutral guides for drills with D = 2.5mm, 3/1 holes

188825

Drill guide for compression plates, for drills with D = 2.0mm

188920

Drill guide for compression plates, for drills with D = 2.5mm

188925

Mini drill guide, for drills with 1.1mm and D = 1.5mm

98188811

Triple drill guide / Sleeve for drills with D = 2.0mm, 3-/1-holes

98188820

for self compressing bone plates with D = 2.0mm, 3/1 holes(EICKEMEYER)
D = 2.0mm, 3/1 holes(EICKEMEYER)

not illustrated

98188920

Triple drill guide / Sleeve for drills with D = 2.5mm, 3-/1-holes

98188825

for self compressing bone plates with D = 2.5mm , 3/1 holes(EICKEMEYER)
not illustrated

98188925



Cortical Screws

CORTICAL SCREWS by EICKEMEYER or AESCULAP

- pack of 5 pcs

d = 1.5mm



L = 6mm	98185206
L = 7mm	98185207
L = 8mm	98185208
L = 9mm	98185209
L = 10mm	98185210
L = 11mm	98185211
L = 12mm	98185212
L = 14mm	98185214
L = 16mm	98185216
L = 18mm	98185218
L = 20mm	98185220

AESCULAP

185206
185207
185208
185209
185210
185211
185212
185214
185216
185218
185220



98185210

d = 2.0mm



L = 6mm	98185306
L = 8mm	98185308
L = 10mm	98185310
L = 12mm	98185312
L = 14mm	98185314
L = 16mm	98185316
L = 18mm	98185318
L = 20mm	98185320
L = 22mm	98185322
L = 24mm	98185324

AESCULAP

185306
185308
185310
185312
185314
185316
185318
185320
185322
185324



98185310

d = 2.7mm



L = 8mm	98185408
L = 10mm	98185410
L = 12mm	98185412
L = 14mm	98185414
L = 16mm	98185416
L = 18mm	98185418
L = 20mm	98185420
L = 22mm	98185422
L = 24mm	98185424
L = 28mm	98185428

AESCULAP

185408
185410
185412
185414
185416
185418
185420
185422
185424
185428



98185410

CORTICAL SCREWS by EICKEMEYER or AESCULAP

- pack of 5 pcs

d = 3.5mm

L = 10mm	98185510
L = 12mm	98185512
L = 14mm	98185514
L = 16mm	98185516
L = 18mm	98185518
L = 20mm	98185520
L = 22mm	98185522
L = 24mm	98185524
L = 26mm	98185526
L = 28mm	98185528
L = 30mm	98185530
L = 32mm	98185532
L = 36mm	98185536
L = 40mm	98185540
L = 45mm	98185545
L = 50mm	98185550

AESCULAP

185510
185512
185514
185516
185518
185520
185522
185524
185526
185528
185530
185532
185536
185540
185545
185550

**98185516****d = 4.5mm**

L = 14mm	98185714
L = 16mm	98185716
L = 18mm	98185718
L = 20mm	98185720
L = 22mm	98185722
L = 24mm	98185724
L = 26mm	98185726
L = 28mm	98185728
L = 30mm	98185730
L = 32mm	98185732
L = 34mm	98185734
L = 36mm	98185736
L = 38mm	98185738
L = 40mm	98185740
L = 42mm	98185742
L = 44mm	98185744
L = 46mm	98185746
L = 48mm	98185748
L = 50mm	98185750
L = 52mm	98185752
L = 54mm	98185754
L = 56mm	98185756
L = 58mm	98185758
L = 60mm	98185760

AESCULAP

185714
185716
185718
185720
185722
185724
185726
185728
185730
185732
185734
185736
185738
185740
185742
185744
185746
185748
185750
185752
185754
185756
185758
185760

**98185724**

Orthopaedic Kits

SCREW SET

Includes Sterilizing Container
188010

1.5 MM SCREWS

98185207	4	L = 7 mm
98185208	4	L = 8 mm
98185209	4	L = 9 mm
98185210	4	L = 10 mm
98185211	4	L = 11 mm
98185212	4	L = 12 mm
98185213	4	L = 13 mm
98185214	4	L = 14 mm
98185216	4	L = 16 mm

2 MM SCREWS

98185306	4	L = 6 mm
98185308	4	L = 8 mm
98185310	4	L = 10 mm
98185312	4	L = 12 mm
98185314	4	L = 14 mm
98185316	4	L = 16 mm
98185318	4	L = 18 mm
98185320	4	L = 20 mm
188011	1	Screw Rack 1.5/2.0 mm (gold)
188012	1	Screw Rack 2.7 (red)
188013	1	Screw Rack 3.5 mm (silver)

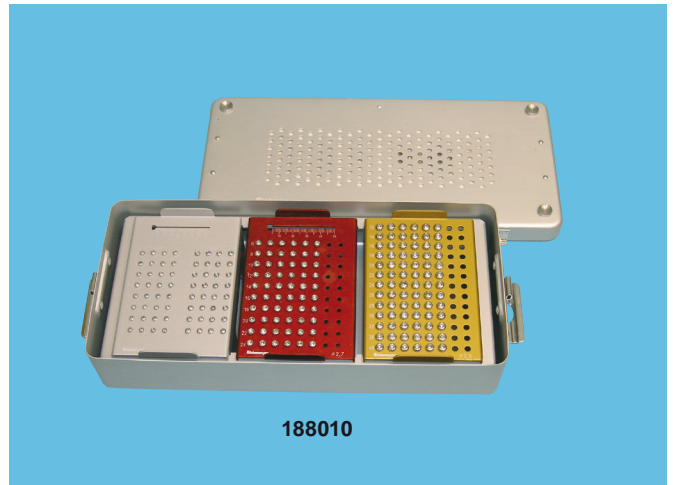

188010

2.7 MM SCREWS

98185406	8	L = 6 mm
98185408	8	L = 8 mm
98185410	8	L = 10 mm
98185412	8	L = 12 mm
98185414	8	L = 14 mm
98185416	8	L = 16 mm
98185418	8	L = 18 mm
98185420	8	L = 20 mm
98185422	8	L = 22 mm
98185424	8	L = 24 mm

3.5 MM SCREWS

98185510	8	L = 10 mm
98185512	8	L = 12 mm
98185514	8	L = 14 mm
98185516	8	L = 16 mm
98185518	8	L = 18 mm
98185520	8	L = 20 mm
98185522	8	L = 22 mm
98185524	8	L = 24 mm
98185526	8	L = 26 mm
98185528	8	L = 28 mm
98185530	8	L = 30 mm
98185532	8	L = 32 mm

PLATE SET 1.5–3.5 MM

Including Sterilizing Container
Rack for Bone Plates (3) and Trays
10 Additional Plate Fixation Pins
188020

MINI BONE PLATES, SELF-COMPRESSING, For Screws with 1.5 and 2.0 mm diameter Width: 5 mm, Thickness: 1 mm

98187604	14 holes,	L = 22 mm
98187605	15 holes,	L = 27 mm
98187606	16 holes,	L = 32 mm
98187607	17 holes,	L = 37 mm
98187608	18 holes,	L = 42 mm

MINI BONE PLATES WITH ROUND HOLES for Screws with 2.7 mm diameter Width: 7 mm, Thickness: 1 mm

98187704	14 holes,	L = 33 mm
98187706	16 holes,	L = 49 mm
98187708	18 holes,	L = 65 mm

SMALL BONE PLATES, SELF-COMPRESSING, For Screws with 2.7 mm diameter, Width: 8 mm, Thickness 2 mm

98187804	14 holes,	L = 36 mm
98187805	25 holes,	L = 44 mm
98187806	26 holes,	L = 52 mm
98187807	27 holes,	L = 60 mm
98187808	38 holes,	L = 68 mm
98187809	29 holes,	L = 76 mm
98187810	310 holes,	L = 84 mm
98187812	212 holes,	L = 100 mm

BONE PLATES, SELF-COMPRESSING, For Screws with 3.5 and 4.0 mm diameter, Width 10 mm, Thickness 3 mm

98188105	15 holes,	L = 64 mm
98188106	26 holes,	L = 75 mm
98188107	27 holes,	L = 86 mm
98188108	28 holes,	L = 98 mm
98188110	310 holes,	L = 122 mm
98188112	212 holes,	L = 146 mm

MINI T-PLATES WITH ROUND HOLES, Width: 7 mm, Thickness: 1 mm

98187905	15 holes, L = 32 mm
----------	---------------------

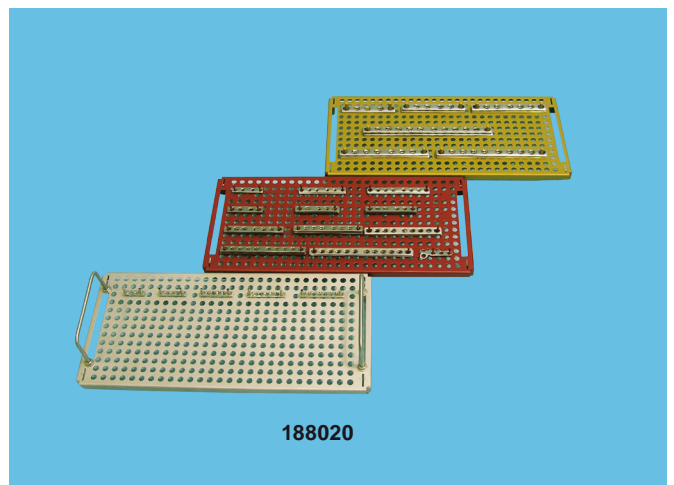

188020

INSTRUMENT SET

Includes Sterilizing Container
and Trays
188000



DRILLS

- 98186111 2 d = 1.1 mm
- 98186115 2 d = 1.5 mm
- 98186120 2 d = 2.0 mm
- 98186125 2 d = 2.5 mm
- 98186127 2 d = 2.7 mm
- 98186135 1 d = 3.5 mm

TAPS

- 98186315 2 For Screws 1.5 mm
- 98186320 2 For Screws 2.0 mm
- 98186427 1 For Screws 2.7 mm
- 98186435 1 For Screws 3.5 mm

DRILL GUIDE SLEEVES

- 98188811 1 Mini Drill Guide, for drills 1.1 mm and 1.5 mm
- 98188820 1 Mini Drill Guide, for drills with 2.0 mm diameter, 3-/1 holes
- 98188825 1 Mini Drill Guide, for drills with 2.5 mm diameter, 3-/1 holes

DRILL GUIDE FOR COMPRESSION PLATES

- 98188920 1 For Drills with d = 2.0 mm
- 98188925 1 For Drills with d = 2.5 mm

PROTECTION SLEEVE

- 98189435 1 For Drills and Taps up to D = 3.5 mm

SCREW DRIVERS

- 98187215 1 For Cortical Screws with D = 1.5 and 2.0 mm
- 98187225 1 For Cortical Screws with D = 2.7 and 4.0mm
- 98189206 1 Bending Iron, 3.5/2.7 mm, 14 cm
- 98189207 1 Bending Iron, 14 cm



188000

INSTRUMENTS

- 98166118 1 Raspatory Handle 18 cm, 6 mm, sharp
- 98182813 1 Bone Fragment Reduction Forceps, 13.5 cm
- 98182820 1 Bone Fragment Reduction Forceps, 20 cm
- 98183014 2 Bone Holding Forceps 13.5 cm
- 180482 1 Hajek
- 182456 1 Lambotte, 12.5 cm, 6 mm
- 182460 1 Lambotte, 12.5 cm, 10 mm
- 182465 1 Lambotte, 12.5 cm, 15 mm
- 98182710 2 Bone Retractor, 22 cm, 10 mm

DRILL GUIDE SLEEVES

- 98189320 1 For Drills with d = 2.0 mm
- 98189327 1 For Drills with d = 2.7 mm

DEPTH GAUGE

- 98184444 1 6–40 mm
- 98188442 1 6–26 mm

K-WIRE AND CERCLAGE SET

Includes Sterilizing Container
and Sorting Rack
188030



K-WIRE, TROCAR/TROCAR POINT 16 CM, 10/BOX

- 180758 1 d = 0.8 mm
- 180760 1 d = 1.0 mm
- 180762 1 d = 1.2 mm
- 180764 1 d = 1.4 mm
- 180766 1 d = 1.6 mm
- 180768 1 d = 1.8 mm
- 180770 1 d = 2.0 mm

CERCLAGE WIRE, SOFT, ROLL WITH 10 M

- 181402 1 d = 0.2 mm
- 181404 1 d = 0.4 mm
- 181406 1 d = 0.6 mm
- 181408 1 d = 0.8 mm
- 181410 1 d = 1.0 mm
- 181412 1 d = 1.2 mm
- 181415 1 d = 1.5 mm

INSTRUMENTS

- 181011 1 K-Wire Bending Instrument
- 181315 1 Wire tightener, 15 cm, TC
- 180922 1 Pin Cutter up to d = 3.5 mm, (soft wire) or d = 2.5 mm (hard wire), 22 cm, TC

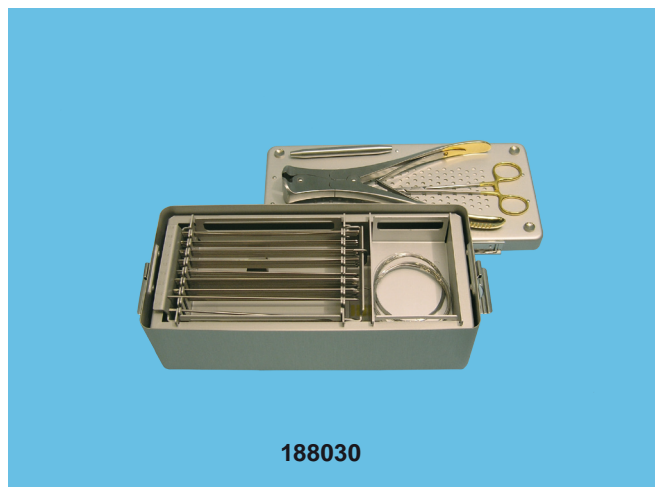

188030

VET **Eickemeyer**®









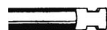

Medizintechnik für Tierärzte

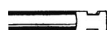

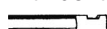

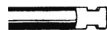
Continuing Education Centre

Drills, Taps, Counter Sinks, Screw Drivers

	Shaft	Screw Ø	Drills Ø	AESCULAP		E		
Drills for throughhole	with dental shaft	1.5	1.5	186015				
		2.0	2.0	186020				
	with round/square shaft	1.5	1.5	186115		98186115		
		2.0	2.0	186120		98186120		
		2.7	2.7	186127		98186127		
		3.5	3.5	186135		98186135		
		4.5	4.5	186145		98186145		
Drills for core hole	with dental shaft	1.5	1.1	186011				
			2.0	1.5	186015			
		2.7	2.0	186020				
	with round/square shaft	1.5	1.1	186111		98186111		
		2.0	1.5	186115		98186115		
		2.7	2.0	186120		98186120		
		3.5	2.5	186125		98186125		
		4.5	3.2	186132		98186132		
Taps	with dental shaft	1.5		186315				
			2.0		186320			
	with round/square shaft	1.5				98186315		
		2.0				98186320		
		2.7		186427		98186427		
		3.5		186435		98186435		
		4.0		186440		98186440		
4.5		186445		98186445				
Counter sink	with dental shaft	1.5/2.0		186615				
								
		with round/square shaft	2.7/3.5/4.0		186727		98186727	
4.5				186745		98186745		
Screw drivers	with dental shaft	1.5/2.0		186915				
								
		with round/square shaft	2.7/3.5		187025			
4.5				187035				
with hard press handle			1.5/2.0		187215		98187215*	
		2.7/3.5		187225		98187225*		
		4.5		187235		98187235*		
Screw Holding Sheat		1.5/2.0		185970				
		2.7/3.5		185980				

*incl. sleeve

Screw Racks, Trans Ilias Nut, Drill Guide / Tissue Protector Sleeves, Drill Insert Sleeves

SCREW RACKS

For screws with D = 1.5/2.0mm, 1.5mm screws from 7 to 16mm, 4 each; 2.0mm screws from 6 to 20mm, 4 each

188011

For screws with D = 2.7mm, 2.7mm screws from 6 to 24mm, 8 each

188012

For screws with D = 3.5mm, 3.5mm screws from 12 to 40mm, 8 each

188013



TRANS – ILIAL SCREWS AND NUTS

For the both sided iliosaceal luxation in cats
- for 2.7mm screws with 44–50mm length

185450

Cortical screw, D = 2.7mm, length = 44mm
not illustrated

98185444

Cortical screw, D = 2.7mm, length = 46mm
not illustrated

98185446

Cortical screw, D = 2.7mm, length = 48mm
not illustrated

98185448

Cortical screw, D = 2.7mm, length = 50mm
not illustrated

98185450

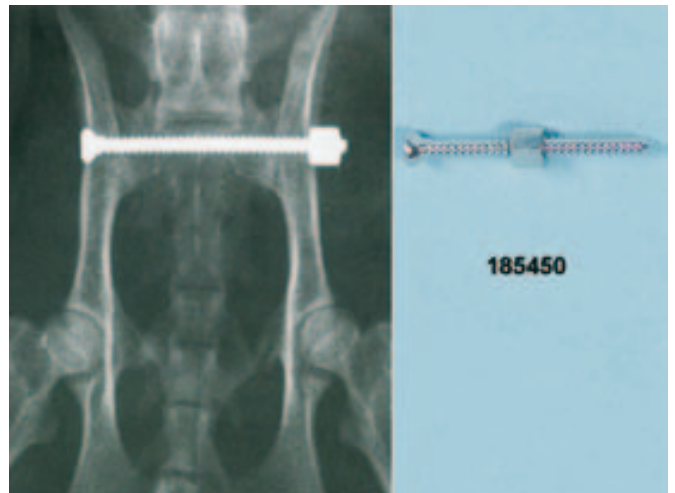

DRILL GUIDE / TISSUE PROTECTOR SLEEVES

Protection Sleeve for drills/taps up to
D = 3.2mm

189432

Protection Sleeve for drills/taps up to
D = 3.5mm

189435

Protection Sleeve for drills/taps up to
D = 4.5mm

189445

Pointed drill guide, for drills with
D = 3.5mm

189535

Pointed drill guide, for drills with
D = 4.5mm

189565

Aiming device d = 3.5mm (EICKEMEYER)

98189535

DRILL INSERT SLEEVE

Centre smaller drills for lag screws placement

for drills with D = 2.0mm

189320

for drills with D = 2.7mm

189327

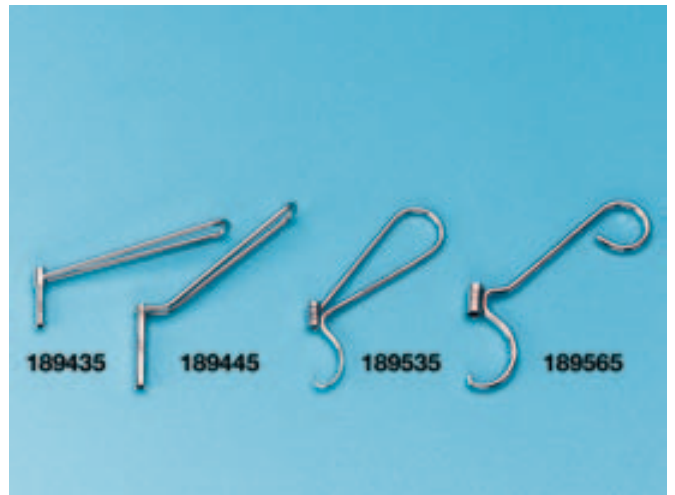

No-Contact-Plates

Osteosynthesis with No-Contact plate (NCP) – A new biological implant system!

This new method of a biological fracture treatment – the No-Contact Plate – describes a new monocortical bone plate system with no contact to the bone. Experimental studies which compared this new method with the established Dynamic Compression Plate (DCP) – osteosynthesis at models and tibia of dead dogs revealed similar results. In the clinical trial, fractures of the femur and the tibia were treated with the NCP. The healing time of the fractures was half the time compared to fractures treated with the DCP. No avascularisation or necrotic defects of periost or cortical bone were seen under the plate.

Set for Screws with D = 2.0mm 192400

192418	10	Corticall Screws, with cone thread, lengthh 8mm
192420	10	Corticall Screws, with cone thread, lengthh 10mm
192422	10	Corticall Screws, with cone thread, lengthh 12mm
192404	1	No-Contact-Platte, width 5.3mm, 4 holes
192406	1	No-Contact-Platte, width 5.3mm, 6 holes
192408	1	No-Contact-Platte, width 5.3mm, 8 holes
192410	1	No-Contact-Platte, width 5.3mm, 10 holes
192490	3	Drill sleeve
192492	1	Drill
192494	1	Screw driver with handle
192496	1	Screw holding forceps
192497	5	KIRSCHNER Wire, trocar point, 1.8x150mm
192498	1	Tray



Set for Screws with D = 3.5mm 192500

192520	10	Corticall Screws, with cone thread, lengthh 10mm
192522	10	Corticall Screws, with cone thread, lengthh 12mm
192514	10	Corticall Screws, with cone thread, lengthh 14mm
192516	10	Corticall Screws, with cone thread, lengthh 16mm
192518	10	Corticall Screws, with cone thread, lengthh 18mm
192504	1	No-Contact-Platte, width 10mm, 4 holes
192506	1	No-Contact-Platte, width 10mm, 6 holes
192508	1	No-Contact-Platte, width 10mm, 8 holes
192510	1	No-Contact-Platte, width 10mm, 10 holes
192590	2	Drill sleeve
192592	1	Twist drill, for quick release
192594	1	Screw driver with handle
192596	1	Screw holding forceps
192597	5	KIRSCHNER Wire, trocar point
192598	1	Tray



NON-CONTACT PLATE

- extension 25mm
- for screws with 3.5mm diameter
- width = 10mm
- thickness = 3.2mm

4 holes, length = 27mm

192504

6 holes, length = 37mm

192506

8 holes, length = 47mm

192508

10 holes, length = 57mm

192510

NCP-CORTICAL SCREWS

- with conical thread
- self tapping
- D = 3.5mm

Length = 10mm

192520

Length = 14mm

192514

Length = 16mm

192516

Length = 18mm

192518



Bone Cement, Lubra-Plates, Spinal Instruments, Toggle Pin Instrumentation



BONE CEMENT CERAFIX H

- sterile packed
- rapid set cement
- extremely durable

CERAFIX H, Pack with 40g
190748

Mixing cup, autoclavable, blue, 280ml
190741

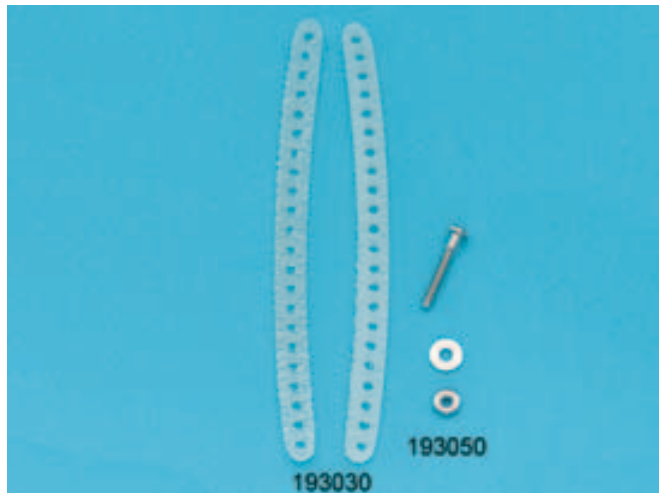

LUBRA-PLATES

- easy and safe fixation of spinal fractures
- autoclavable

9.5cm, small, pair

193010

14cm, medium, pair

193020

20cm, large, pair

193030

Screw with washer and nut for LUBRA plates
193050

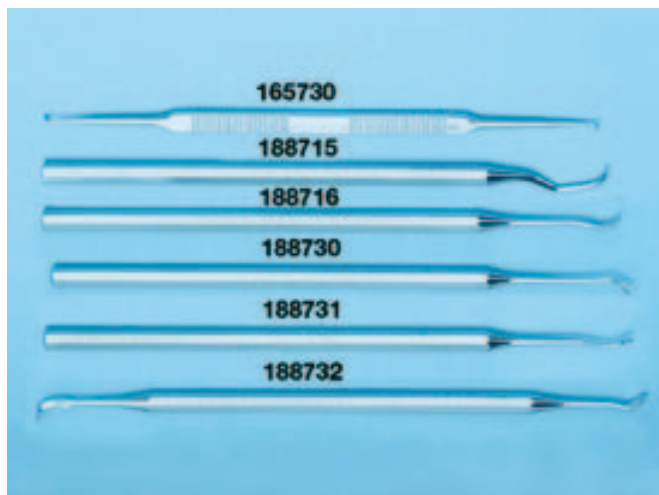

SPINAL INSTRUMENTS

Curette HOUSE, 1.0 / 1.2mm, 15cm, especially for spinal disease surgery

165730

Sharp hook, 15cm

188715

Blunt hook KASA, 15cm

188716

Intervertebral disc scoop, right

188730

Intervertebral disc scoop, left

188731

Intervertebral disc scoop, CUMINE, double ended

188732

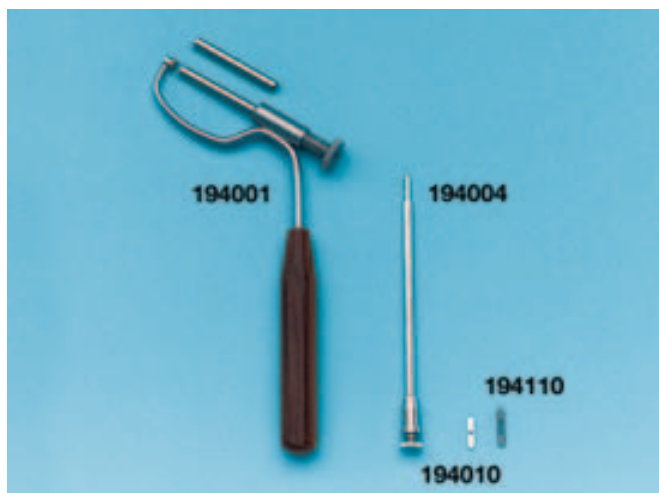

TOGGLE PIN INSTRUMENTATION WALLA

Special drill guide WALLA with two sleeves (short and long)

194001

Drill guide WALLA, with mandrin

194004

Toggle pins WALLA, small, 10/pkg.

194010

Toggle pins WALLA, large, 10/pkg.

194110

ORTHOPAEDIC WASHER

D = 7.0mm, for 2.7–3.5mm screws

185907

D = 11.0mm, for 3.5–4.5mm screws

185911

ORMROD-SCHMITT

181416



SPIKEY WASHERS

Stainless steel

For screws with 2.7mm diameter, OD: 8.0mm,
ID: 4.0mm

191892

For screws with 3.5mm, OD: 13.5mm, ID:
4.0mm

191893

For screws with 4.5mm, OD: 14mm, ID: 5.0mm

191894

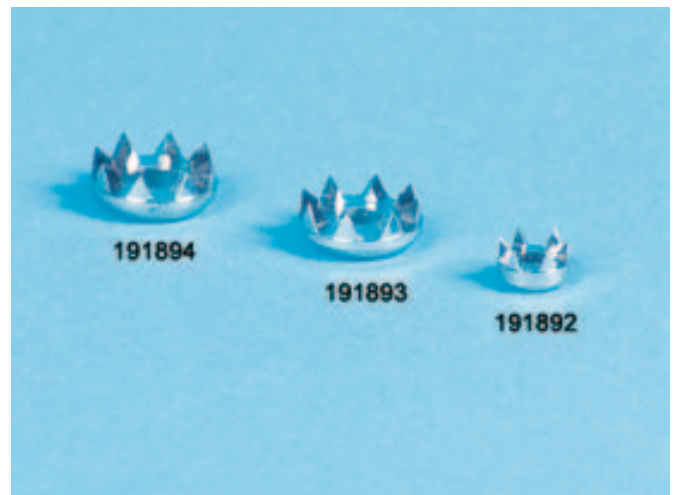

VET Eickemeyer®

Your reliable source for
innovative products

Electrosurgery Set OrthoVET



ELECTROSURGERY SET ORTHOVET

Electrosurgery Set OrthoVET incl. foot control, flexible micro cable, handpiece and JACOBS chuck

- powerful and silent
- infinite variable speed
- flexible micro cable, length = 175cm, autoclavable
- ideal for drilling, introduction of bone pins and screwing
- right/left turn
- fully cannulated handpiece
- universal JACOBS chuck for instruments with shank up to 4.0mm diameter

195060

Intra angle piece, no key needed for tightening, transmission 1:2, up to 36000 rpm

- especially for spinal surgery

19760201

Oscillating Saw compatible with OrthoVet

19600001

AESCULAP ELECTRO-SURGERY MOTOR ELAN-VET-LINE

- The ELAN-VET-LINE combines modern technology with practical application
- providing more power for precise application
 - high-speed and high torque
 - smooth running
 - electronic brake
 - improved visibility of system status by new indication elements
 - universal for drilling, sawing, reaming and shaving in just one system
 - right/left turn

195001

Special Oil for handpiece GA 59, 50 ml, for the care of your flexible micro cable and handpieces

not illustrated

195059

PNEUMATIC SURGICAL MOTOR SYSTEM MINILAN

- For small animal surgery
- micromotor, easy to handle
 - smooth motion
 - powerful (100 Watt output)
 - infinitely variable speed control from 0–20.000 rpm
 - forward and reverse gear
 - intracoupling (suitable for all small animal handpieces)
 - smooth starting
 - optimised air circulation seal

198410

ACCESSORIES FOR MINILAN

Connection hose between MINILAN and foot control with quick-air-stop coupling, length = 3m, autoclavable

198401

Foot Switch for infinitely variable speed control

198402

Connection hose, for air supply and extraction with quick-air-stop coupling, autoclavable

198403



195001

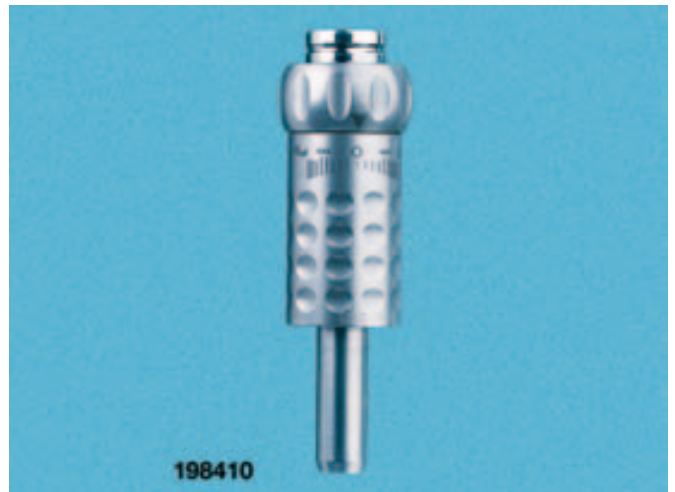

198410

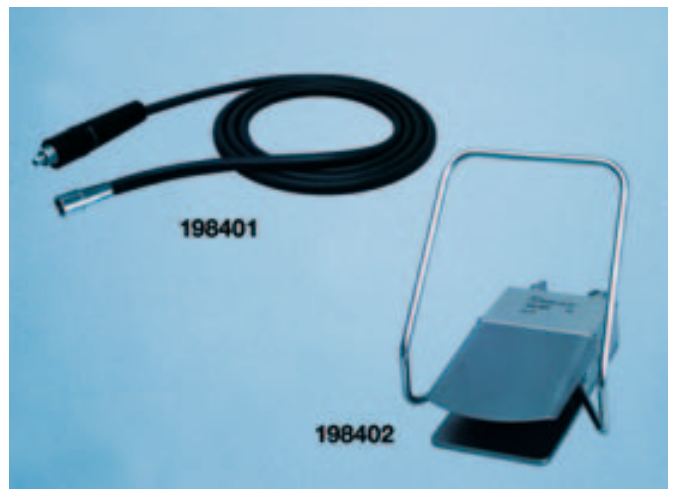

198401

198402

Accessories for ELAN-VET-LINE and MINILAN, Hand Pieces, Oscillating Saw

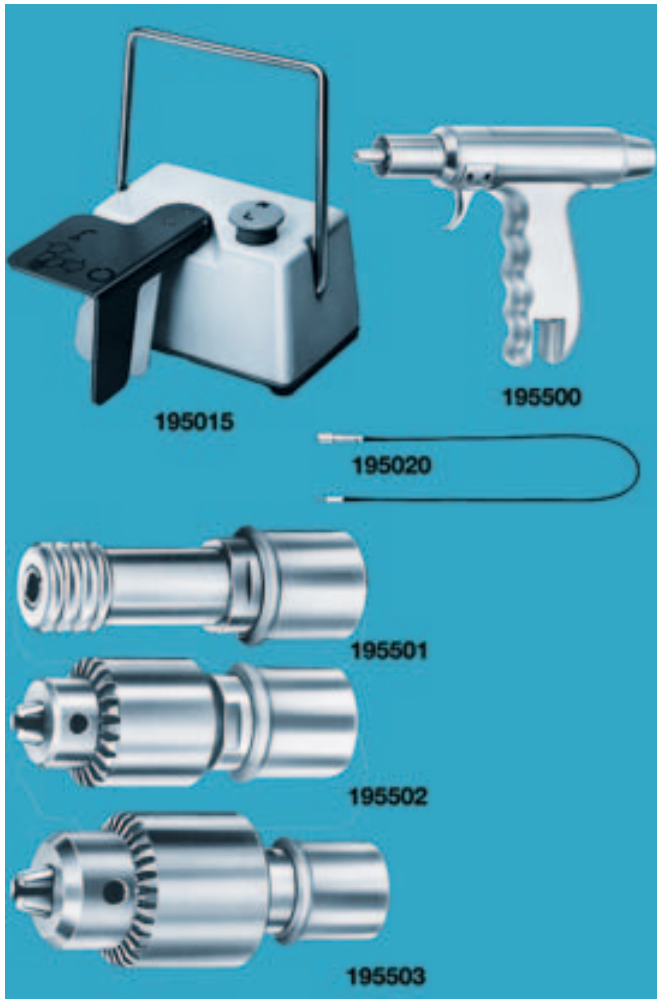

ELAN-VET-LINE AND MINILAN ACCESSORIES

One power system for all professional surgical procedures

Foot Switch with moveable lever for ELAN-VET-LINE

195015

Flexible micro cable for ELAN-VET-LINE, length = 180cm, autoclavable

195020

Hand piece with forward and reverse gear, fully cannulated

195500

Quick release chuck for 4 square shanks

195501

Universal JACOBS chuck for instruments with shanks up to 4mm diameter, with key

195502

Universal JACOBS chuck for instruments with shanks up to 6.35mm diameter, with key

195503

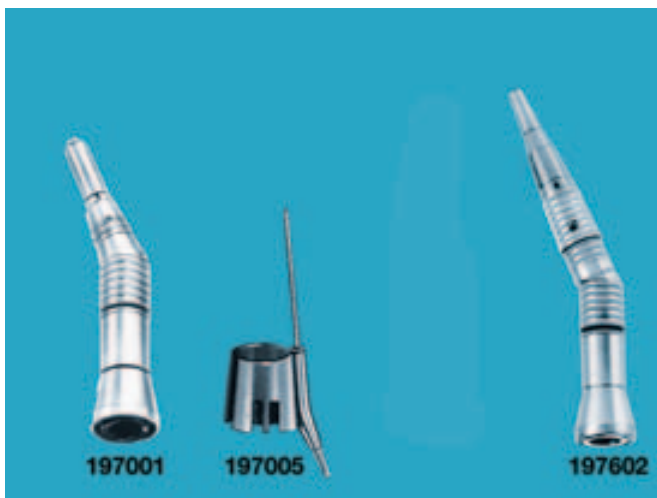

HAND PIECES FOR ELAN-VET-LINE AND MINILAN

- quick exchange

Intra-angle handpiece, transmission 1:1, 0-22000 rpm

197001

Spray nozzle with clamp for 197001

197005

Intra-angle handpiece, transmission 1:2, 0-36000 rpm 0-36000 rpm

197602



OSCILLATING SAW

- 18.000 mpm

- surgical blade swivels up to 75°

Oscillating Saw for flexible micro cable, w/o blades

196000

SAW BLADES

Width = 10mm, length = 60mm

196010

Width = 20mm, length = 60mm

196020

Width = 10mm, length = 75mm

196110

Width = 20mm, length = 75mm

196120

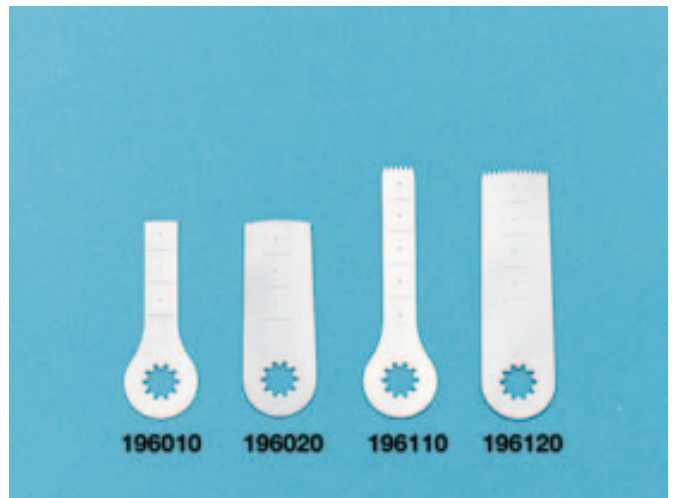

SURGICAL BURS

- length = 70mm

- with round shaft, D = 2.3mm

Head size: D = 3.1mm

197831

Head size: D = 4.0mm

197840

Head size: D = 5.0mm

197850

Head size: D = 6.0mm

197760

Head size: D = 7.0mm

197770



SURGICAL SUCTION DEVICE ECONOMY

Economically priced Surgical Suction Device

- high suction power

- up to 20 l/min

- up to 80% max vacuum

- complete with 2 litre suction glass and cover

- 2m surgical suction tube (autoclavable)

199080

Suction tube ID = 7mm, autoclavable

(sold by the meter)

199087



Surgical Suction Devices, Suction Tips, Canine and Feline Mouth Gags, Catching Net



306050

ELECTRIC SUCTION PUMP

- suction power up to 25 l/min
 - vacuum up to -650 bar
 - suction tube DI = 6mm, length = 1.25m
 - with suction glass 1000ml
 - portable
- 306050**



199219

199230

SUCTION TIPS

Attach to most suction pumps

Curved, length = 19cm

199219

FERGUSSON, D = 3.0mm

199230

FERGUSSON, D = 5.0mm

199250

YANKAUER disposable suction set, curved
Tubus: 200cm, 6.0x8.5mm Handpiece: 22cm,
4.5x6.5mm
not illustrated

455520



200206

200205

WEDGE MOUTH GAGS

- anatomic design for secure placement
- soft and pliable for cats and dogs
- radiolucent
- autoclavable

For dogs

200206

For cats

200205

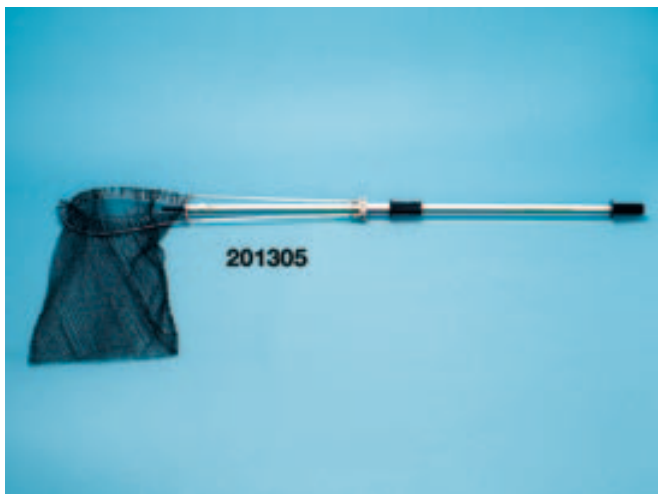

201305

CATCHING NET

For small pets and cats

- designed for safe and easy handling of animals
- constructed of tough nylon webbing
- easy to open and close
- Length = 150 cm

201305

QUICK RELEASE DOG SNARE

Length = 149cm

- quick-release mechanism
- pull handle to tighten, turn handle to lock and release
- plastic coated cable to avoid injuries
- durable and lightweight aluminium construction

201012

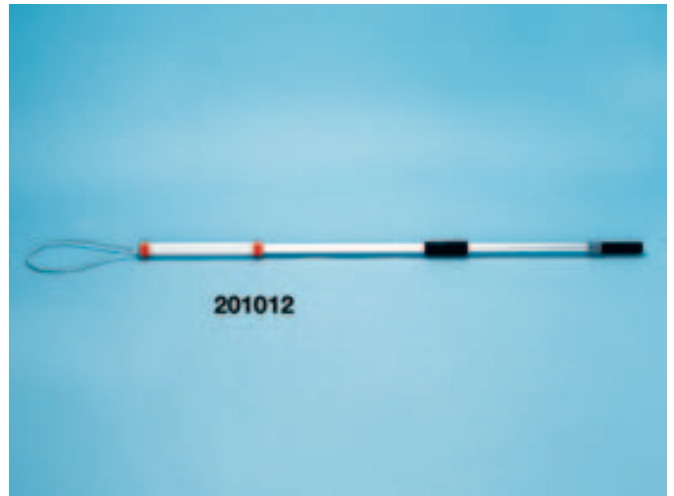

CAT CATCHER

Length = 76cm

- easy restraint of cats at a safe distance
- reinforced aluminium
- curved, plastic covered jaws to minimise discomfort

200570

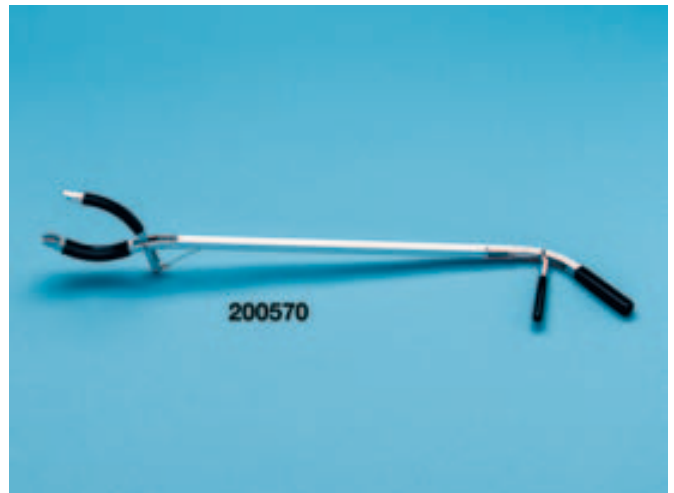

RESTRAINT GLOVES

Pair of strong leather, double thickness gloves

- heavy-duty material
- increased padding
- 40cm length for extra protection

201500



RESTRAINT GLOVES

Pair of strong leather gloves

- length = 30cm

20150001



Cat Trap, Restraining Equipment

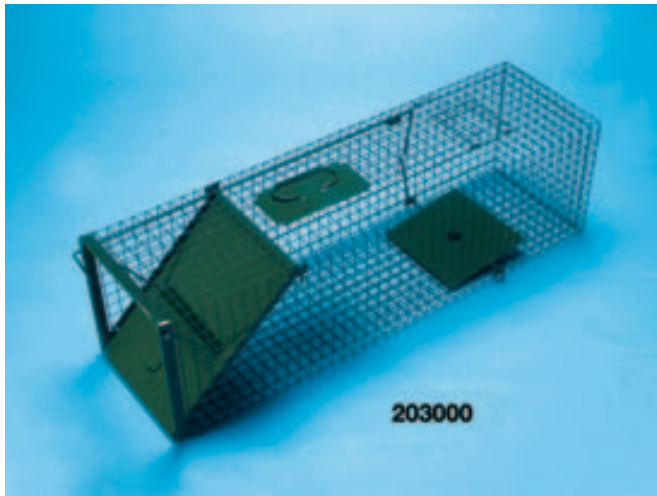

CAT TRAP

- Animal friendly Trap
 - zinc plated, solid metal construction
 - easy to operate
 - safe
 - dimensions: L = 100cm, W = 28cm, H = 28cm
- 203000**



NOSE TWITCH FOR HORSES

- Wooden, 21.5cm
- 211121**
- Light metal, 37cm
- 211137**
- Plastic, 40cm
- 211140**

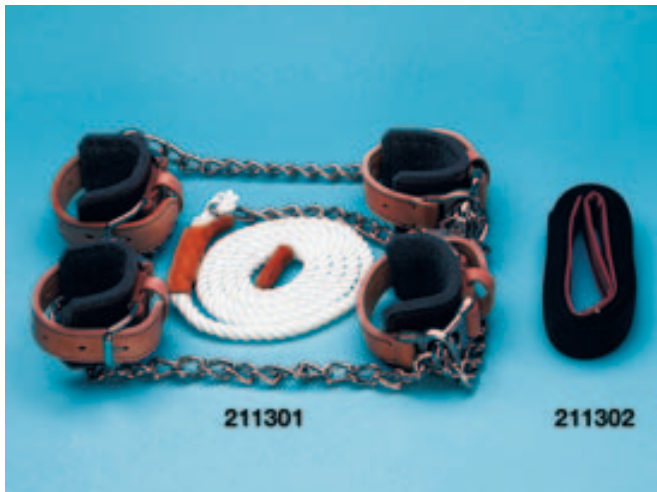

EQUINE RESTRAINT EQUIPMENT BERLIN MODEL

- Easy and safe restraint of the horse during treatment and examination
 - with 4 soft-padded leather cuffs
 - heavy duty buckles
 - easy adjustment
- 211301**
- Fixation band, polyester, length = 9m, width = 5cm
- 211302**



ANAESTHETIC MACHINE EICKEMEYER

Anaesthetic Machine EICKEMEYER for small animals with reconditioned ISOFLURANE Vaporizor

Complet set with:

- absorber soda lime canister
- flowmeter (0.4–4.4 litre/min)
- mobile stand with mounting support for a 10 litre oxygen cylinder
- Bain Circuit for small animals (less then 7kg)
- patient tubing
- 2 litre rebreathing bag
- table top or floor stand model available

Floor Stand Model

213095

Trolley model with new isoflourane TEC3-style vaporizor

213075

Tray for oxygen concentrator

213098

Tray attachment for monitoring devices

213099

Table top model with new isoflourane TEC3-style vaporizor

not illustrated

213076

Table Top Model

213096

Wall mount for anaesthesia machine

213094

Anaesthesia Machine



212005

ANAESTHESIA MACHINE MARTRX VMS ISO

Anaesthesia machine VMS stand model, TEC3 -style vaporizer including:

- Flowmeter 0.2–4 L/min
- transparent soda lime canister (1500 cc)
- pop-off valve
- Pressure gauge
- Oxygen bypass
- moveable stand with 5 castors

212005

Wall mounted model

212007

With EICKEMEYER stand including tray for oxygen cylinder

212009



212010

ANAESTHESIA MACHINE MATRX VMS PLUS

Stand model with TEC3 – style vaporizer including:

- Flowmeter 0.2–4 L/min
- transparent soda lime canister (1500 cc)
- pop-off valve
- Pressure gauge
- Oxygen bypass
- 2nd vaporizer attachable (optional)
- 2nd flowmeter attachment (optional)
- moveable stand with 5 casters
- tray for monitoring devices
- gas evacuation system optional

212010

equipped with EICKEMEYER stand, including holder for 2 separate

212012

Anaesthetic Machines for Small Animals, Anaesthesia Machine, Oxygen Concentrator

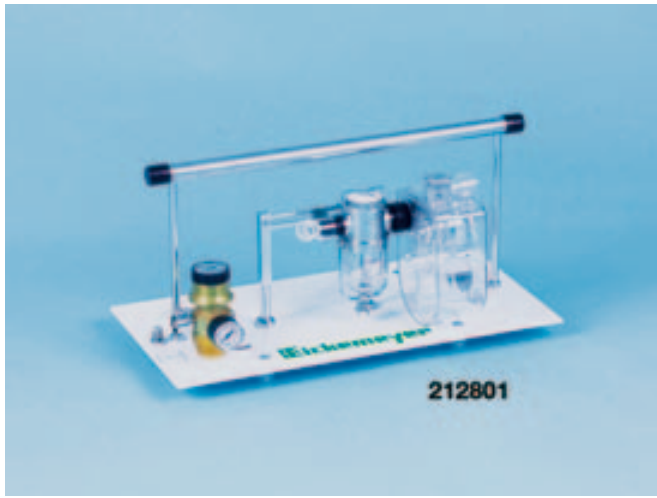

ANAESTHETIC MACHINE MEDVET FOR SMALL ANIMALS

- With universal vaporizer, closed circuit system with low-flow
- complete set with tubing and breathing bag
 - closed circuit with transparent CO₂ absorber
 - universal vaporizer
 - economical
 - portable
 - small dimensions
- 212801**



ANAESTHESIA MACHINE RESEARCH FOR LAB ANIMALS

- With reconditioned isoflurane vaporizer (while supply lasts)
- ideal for all animals up to 3kg
 - simple to operate
 - reliable
 - Flowmeter 0–5 lpm
 - compact
- 213086**
- With Isoflurane TEC3 – style vaporizer
- 213087**



OXYGEN CONCENTRATOR OXYVET

- transfers ambient air into oxygen
 - produces up to 95% pure oxygen, up to 5 litre/min
 - almost maintenance free
 - noise free operation
 - can be adapted to fit all major anaesthetic systems
 - also may be used in critical care
 - mobile with 4 castors
 - including flowmeter and humidifier for oxygen therapy
 - dimension: W = 400 H = 700 D = 350
- 213180**

Y Piece to connect an oxygen concentrator to anaesthesia machines and oxygen dose simultaneously

213185

OXYGENCONCENTRATOR OXYVET EASY

- transfers ambient air into oxygen (45 db (A))
 - produces up to 93% pure oxygen, up to 5 l/min
 - maximum output reached after 3 mins of operation
 - attachable to all major anaesthesia machines including flowmeter and humidifier used for oxygen therapy
 - 3 years warranty
- 213170**



213170

VENTILATOR FOR SMALL ANIMALS SAV 2500

Can be connected on all Anaesthetic Machines with closed and open circuits

- electronically controlled
- time cycled
- pressure controlled
- assures constant volume for each delivered breath
- easy to operate
- ensures safe anaesthesia
- adapts easily to anaesthetic circuits with out-of-circuit vaporisers

213015

Paediatric bellow assembly 0–300ml especially for small animals less than 7kg

213017



213015

Ventilator, Reduction Valves, Central Gas Supplying System, Oxygen Emergency Kit



VENTILATOR FOR SMALL ANIMALS

- For assisted and controlled breathing.
- for animals from 1 to 65kg
 - microprocessor electronically ventilates the patient if spontaneous respiration does not occur
 - sets breathing parameters automatically after entering patient's weight
 - can also be used with masks
 - versatile: critical care ventilation or anaesthetic delivery unit (with vaporizer)
 - assures ideal oxygen level
 - rechargeable battery

213011



MEDICAL REDUCTION VALVE

- Keyless connection to all DIN bottles
- with flow control

212704

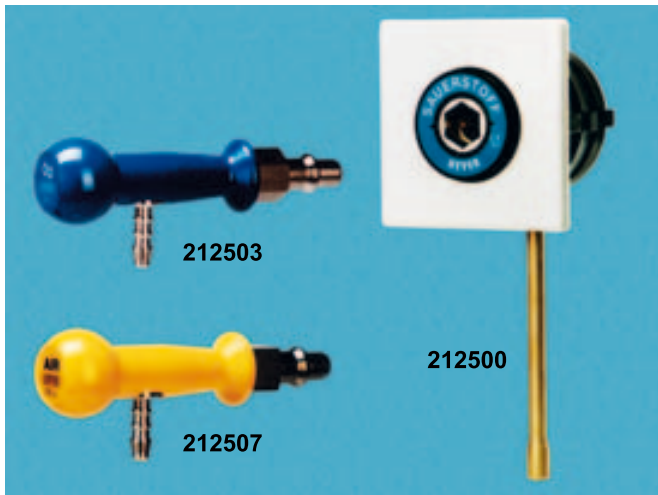

CENTRAL GAS SUPPLYING SYSTEM

Oxygen, recessed
212500

Compressed air, recessed
not illustrated
212505

Compressed air, surface
not illustrated
212506

Oxygen connector
212503

Compressed air connector
212507



OXYGEN EMERGENCY KIT FOR SMALL ANIMALS

- mobile
- with 2 litre oxygen cylinder
- carrying case

Model I, with Reduction Valve 4 LPM
219013



LARGE ANIMAL ANAESTHETIC MACHINE LAVC-2000D

- with BIRD respirator for spontaneous, assisted and/or controlled ventilation
- Flowmeter (0–10 litre/min)
- O₂-Bypass
- flush valve
- pressure gauge
- two 160cm corrugated breathing tubes
- inhaler Y-piece with 4 adapters (18/20/25/30mm)
- optional foal kit (see below)
- with 30 litre breathing bag

Anaesthetic Machine LAVC-2000 D-2, with each one reconditioned ISOFLURANE and HALOTHANE vaporizer
21320001

With new ISOFLURANE vaporizer
21320201

Utility tray for LAVC-2000D, 700x280x15mm
213205

Anaesthetic Machines for Large Animals



LARGE ANIMAL ANAESTHETIC MACHINE LAVC-2000

- with BIRD respirator for spontaneous, assisted and/or controlled ventilation
- Flowmeter (0–10 litre/min) – Bypass
- flush valve
- pressure gauge
- two 160cm corrugated breathing tubes
- inhaler Y-piece with 4 adapters (18/20/25/30mm)
- optional: foal kit (see below)
- with 30 litre breathing bag

With new ISOFLURANE vaporizer
213201



LARGE ANIMAL ANAESTHETIC MACHINE LAPD-1000

- Flowmeter (0–10 litre/min)
- pressure gauge
- patient circuit with Y-piece and 4 adapters (18/20/25/30mm)
- O₂-Bypass
- with 30 litre breathing bag

With TEC3-Style ISOFLURANE vaporizer
213101

Large animal ventilator LAVC 3000
connectable to all major anaesthesia machines
not illustrated
213120



FOAL BREATHING CIRCUIT KIT

Conversion kit for LAVC-2000 to foal ventilator
213220

Small circuit with adapters for foal conversion
213221



ACCESSORIES FOR LARGE ANIMAL ANAESTHETIC MACHINES

Breathing circuit, grey
215710

Y-piece, plastic, large
E213200159

LARGE ANIMAL BREATHING CIRCUIT

Floor stand for large animal breathing circuit

213022

Foal Set for large animal breathing circuit

213025



LARGE ANIMAL BREATHING CIRCUIT MATRIX VML

Anaesthesia machine VML Stand model,
including:

- large soda lime cannister (5200 cc)
- large volume patient tubing with Y-piece
- 30 l breathing bag
- pressure gauge
- Flowmeter (1–10 l/Min)
- mobile stand

212020

Anaesthesia machine VML, as above, with
EICKEMEYER stand and oxygen bottle holder,
not illustrated

- including FEC3-style vaporizer

212021



Vaporisers



213261

EICKEMEYER ISOFLURO VAPORISER

ISOFLURANE Vaporizer

- calibrated dial (0.5%–5% at 0.5% intervals)
- with key filling
- temperature/flow compensated vaporiser
- large sight glass for easy liquid level checks
- with safety lock
- laser-calibrated (0.25 to 5%)

213261

Selectatec Connector

not illustrated

222227

Sevoflurane vaporizer with key filling

not illustrated

213271



222225

RECONDITIONED VAPORISER

Reconditioned DRAEGER ISOFLURANE Vaporizer

- with certificate
- accurate and reliable
- with key filling

222225



222226

VAPORISER CONVERSION

We convert your Vaporizer from HALOTHANE to ISOFLURANE

Including calibration

222222

Pivoting connection for DRAEGER Vaporizer 19.1 or 19.3

- to connect on a used DRAEGER Anaesthetic Machine

222226

SAFETY KEY FILLER FOR NARCOTIC

Fits only on special bottles and vaporizers with key filling system

- with anti-polluting plug
- allows you to rapidly fill your vaporizer

Safety Key Filler for ISOFLURANE (purple)
213246

Safety Key Filler for SEVOFLURANE
213247



CYLINDER CART

White, for one 10 litre O₂-Cylinder
213465



ACTIVE ANAESTHETIC GAS SCAVENGE SYSTEM

- For better conditions in the surgery room
- the active scavenge system provides a safe, cost effective method of ensuring health and safety of the staff in the operating theatre
 - the system exhausts all anaesthetic waste gases without depleting oxygen and anaesthetics from the anaesthetic machine
 - normal anaesthetic protocols need not be altered
 - easy to install

213480

Scavenger tubing per meter
212729



ANAESTHETIC GAS FILTER

- removes excess halogenated gases from the operating theatre
- absorbs up to 200g anaesthetic gas (lasts 20–25 hours)
- easily adaptable

213485



Endotracheal Tubes

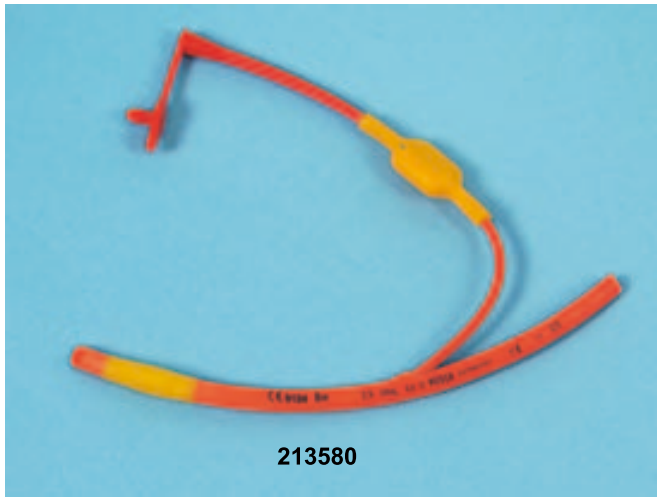

ENDOTRACHEAL TUBES, RED RUBBER WITH INFLATABLE CUFF

- curved, easy to introduce
- bevel tip

ID = 2.5mm, OD = 5.5mm, CH 12
213525

ID = 3.0mm, OD = 6.0mm, CH 14
213530

ID = 3.5mm, OD = 7.0mm, CH 16
213535

ID = 4.0mm, OD = 7.5mm, CH 18
213540

ID = 4.5mm, OD = 8.0mm, CH 20
213545

ID = 5.0mm, OD = 8.5mm, CH 22
213550

ID = 5.5mm, OD = 9.0mm, CH 24
213555

ID = 6.0mm, OD = 10.0mm, CH 26
213560

ID = 6.5mm, OD = 10.5mm, CH 28
213565

ID = 7.0mm, OD = 11.0mm, CH 30
213570

ID = 7.5mm, OD = 11.5mm, CH 32
213575

ID = 8.0mm, OD = 12.0mm, CH 34
213580

ID = 8.5mm, OD = 12.5mm, CH 36
213585

ID = 9.0mm, OD = 13.0mm, CH 38
213590

ID = 9.5mm, OD = 14.0mm, CH 40
213595

ID = 10.0mm, OD = 14.5mm, CH 42
213600

ID = 10.5mm, OD = 15.0mm, CH 44
213610

ID = 11.0mm, OD = 15.5mm, CH 46
213611

ID = 12.0mm, OD = 16.0mm, CH 50
213612

ID = 13.0mm, OD = 17.0mm, CH 54
213613

ID = 14.0mm, OD = 20.0mm, CH 58
213614

ENDOTRACHEAL TUBE, SILICONE-LATEX, WIRE RE-ENFORCED WITH CUFF

- wire re-enforcement prevents from kinking
- conforms to body contours
- high resistance to deterioration
- transparent

ID = 3.0mm, OD = 5.0mm, w/o cuff
213830

ID = 3.5mm, OD = 6.0mm, w/o cuff
213835

ID = 4.5mm, OD = 7.0mm
213845

ID = 5.5mm, OD = 8.5mm
213855

ID = 6.0mm, OD = 9.0mm
213861

ID = 7.0mm, OD = 10.0mm
213871

ID = 8.0mm, OD = 12.0mm
213881

ID = 9.0mm, OD = 13.0mm
213891

ID = 10.0mm, OD = 15.0mm
213810

PVC ENDOTRACHEAL TUBE

- crystal clear
- cuff inflation valve for Luer and Luer lock
- flat, non traumatic tip
- with connector

ID = 2.5mm

214025

ID = 3.0mm

214030

ID = 3.5mm

214035

ID = 4.0mm

214040

ID = 4.5mm, with cuff

214045

ID = 5.0mm, with cuff

214050

ID = 5.5mm, with cuff

214055

ID = 6.0mm, with cuff

214060

ID = 6.5mm, with cuff

214065

ID = 7.0mm, with cuff

214070

ID = 7.5mm, with cuff

214075

ID = 8.0mm, with cuff

214080

ID = 8.5mm, with cuff

214085

ID = 9.0mm, with cuff

214090

ID = 9.5mm, with cuff

214095

ID = 10.0mm, with cuff

214101

ID = 10.5mm, with cuff

214102

ID = 11.0mm, with cuff

214103

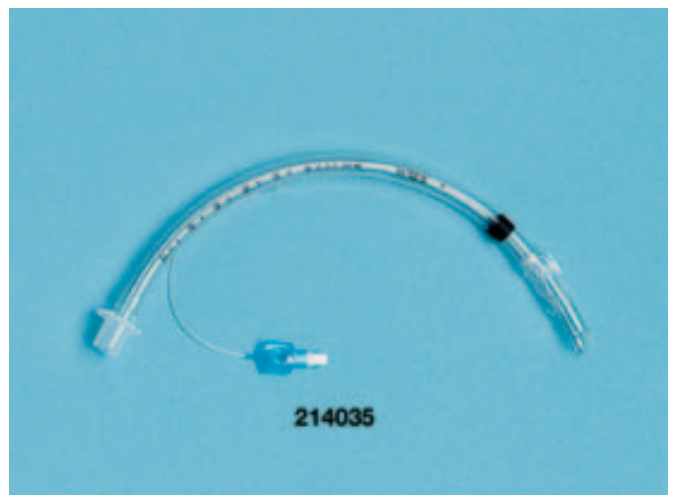
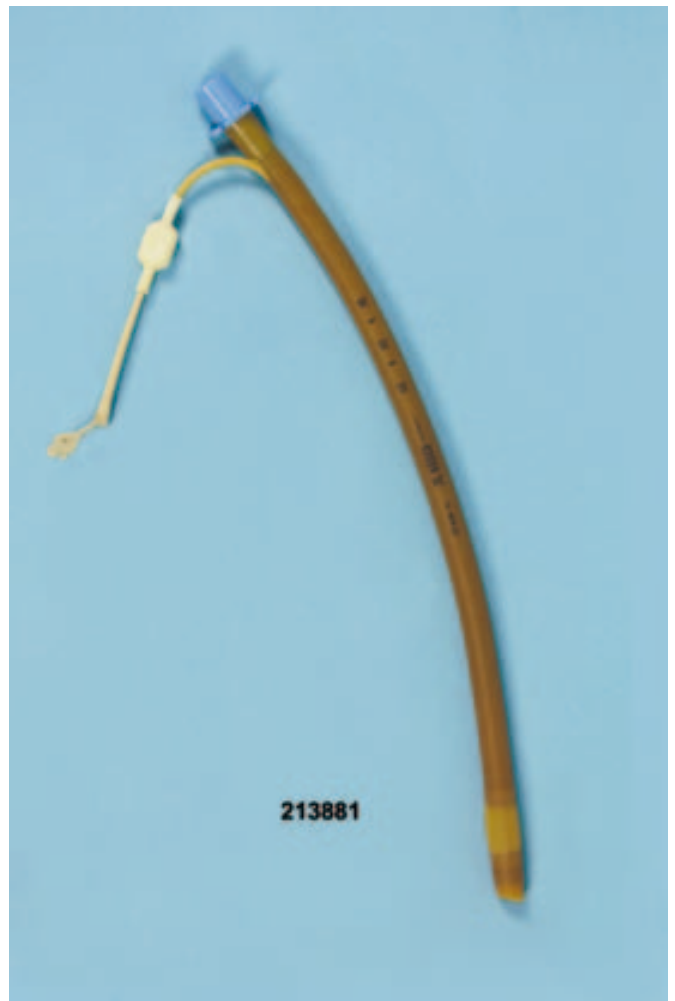

Connector Set, Connectors

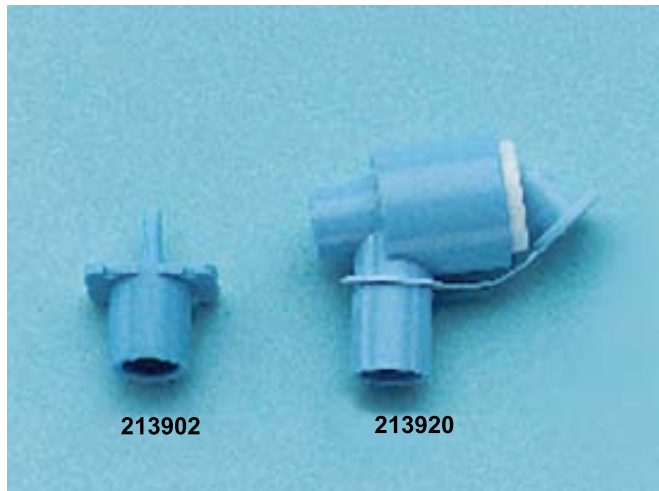

CONNECTOR-SET FOR ENDOTRACHEAL TUBES

2.5–11.0mm, with SWIVEL-Connector
213901

CONNECTORS FOR ENDOTRACHEAL TUBES

- fits to 15mm standard Y-piece
- durable plastic
- adapter size fits tracheal tube inner diameter

2.5mm
213902

3.0mm
213903

3.5mm
213935

4.0mm
213904

4.5mm
213945

5.0mm
213905

5.5mm
213955

6.0mm
213906

6.5mm
213965

7.0mm
213907

7.5mm
213975

8.0mm
213908

8.5mm
213985

9.0mm
213909

9.5mm
213995

10.0mm
213910

10.5mm
213911

11.0mm
213912

15mm
213913

SWIVEL-Connector
213920

Intubation stylets for tracheal tubes
D = 2.6mm, length = 40cm
214126

D = 4.3mm, length = 45cm
214143

D = 5.6mm, length = 50cm
214156

Display Rack for Endotracheal Tubes, Tracheal Tubes, Endotracheal Tubes for Horses

DISPLAY RACK FOR ENDOTRACHEAL TUBES

Designed to dry and hold 15 endotracheal tubes in place by their connectors
- with two hooks for rebreathing bags
- made of stainless steel
213900

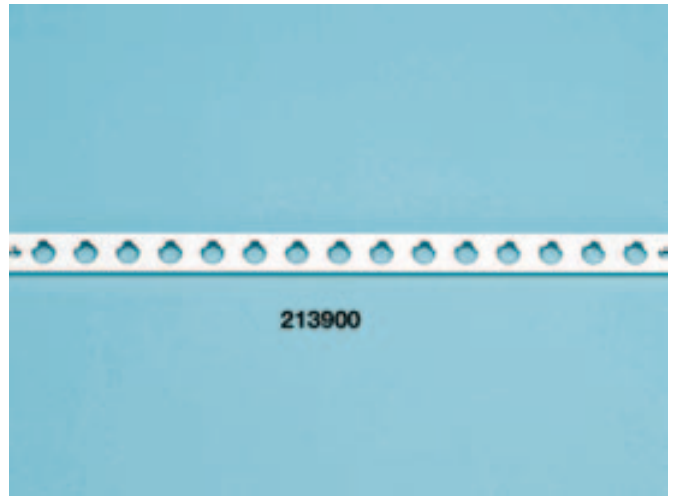

PLASTIC TRACHEAL TUBE FOR SMALL ANIMALS

With obturator for easy insertion
- for long term or temporary use

D = 6mm

214106

D = 10mm

214110



TRACHEAL TUBE FOR HORSES

PAPE pattern

214621



ENDOTRACHEAL TUBE FOR LARGE ANIMALS AND HORSES

- red soft rubber
- strong cuff (appx. 15cm length) with cuff inflator (silicon) and pilot balloon

ID = 18mm, for calves and foals

214218

ID = 25mm, for cattle and horses

214225

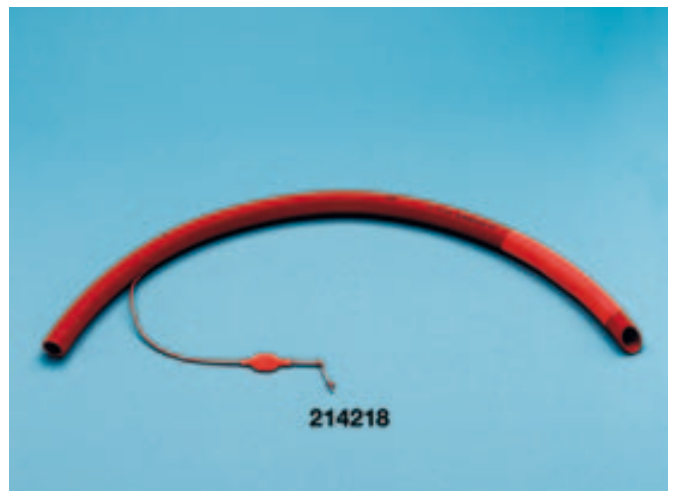

Endotracheal Tubes for Horses, Connectors, Equine Mouth Gags, Teething Ring



214320

ENDOTRACHEAL TUBES ROESCH, RED RUBBER

ID = 20mm, for large calves and foals

214320

ID = 25mm, for cattle and horses

214325

ID = 30mm, for cattle and horses

214330



214501

CONNECTORS FOR ENDOTRACHEAL TUBES

For oversized tracheotubes

12mm

214501

14mm

214502

16mm

214503

18mm for large animal Anaesthetic Machines

214518

20mm/22mm for large animal Anaesthetic Machines

214519

26mm for large animal Anaesthetic Machines

214521

30mm for large animal Anaesthetic Machines

214522

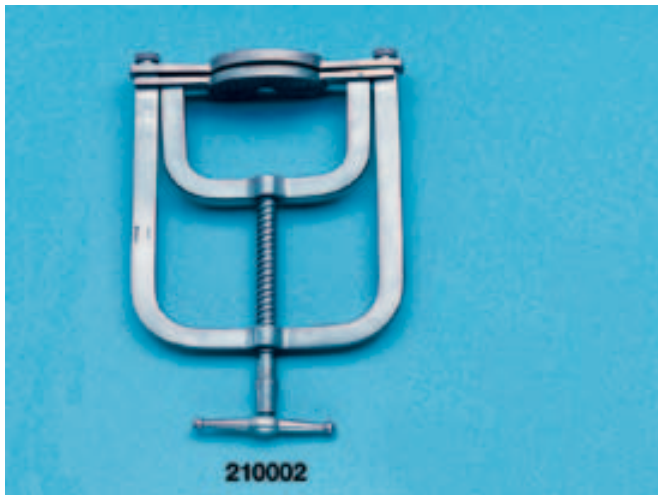

210002

GUENTHER-HEPKE EQUINE MOUTH GAG

- for anaesthetised horses

- opening: 12cm

210002



214001

TEETHING RING

ID = 50mm, height = 70mm, length = 100mm, for horses

- heavy duty plastic construction

- protection of the tracheal tubes

214001

Diagnostic Lamp, Curved Bulb Holder, Laryngoscopes

DIAGNOSTIC LAMP

- ideal for intubation of small animals
- practical for examination of throat, nose, ears and eyes

Diagnostic lamp, includes 2 spatulas (flat and pointed)

214210

Spare spatula, pointed

214212



CURVED BULB HOLDER

For HEINE 3.5V Battery Handle

- 3 different spatula attachments available
- for intubation of small animals

301255

Tongue spatula, narrow, short

301261

Tongue spatula, narrow, long

301262

Tongue spatula, wide, long

301263

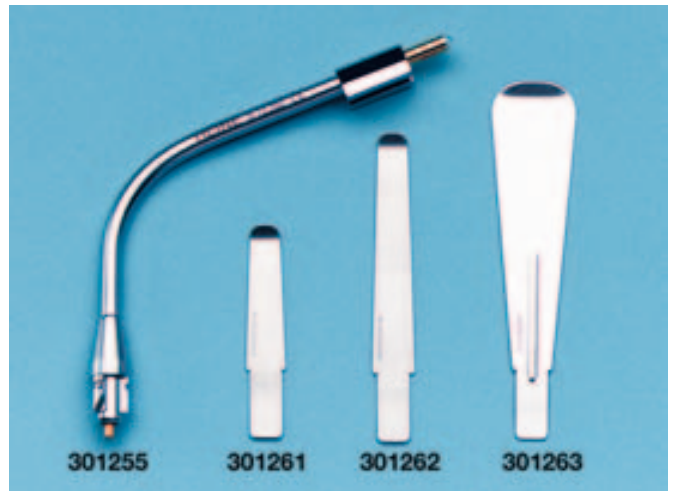

HEINE LARYNGOSCOPE WITH FIBER OPTICS

Laryngoscope handle with rechargeable batteries, 3.5V halogen

301436

Fiber optic laryngoscope spatula, size 2, length = 130mm, width at distal end 16mm

301412

Fiber optic laryngoscope spatula, size 3, length = 160mm, width at distal end 16mm

301413



Laryngoscopes, Accessories for Tracheal Tubes, Anaesthesia Masks



LARYNGOSCOPE ECONOMY

- FREIBURGER model, including spatula and battery handle
- spatula: length = 145mm, width = 15mm (distal end)
 - brilliant illumination
 - sturdy
 - economically priced
 - with batteries
- 301450**



ACCESSORIES FOR TRACHEAL TUBES

- Silicon Spray 500ml
214600
- Tracheal Cuff Inflator to inflate equine tracheotubes
214605



SMALL ANIMAL ANAESTHESIA MASKS

- durable clear plexiglass
- with rubber diaphragms
- excellent seal
- quick release

- Small
214801
- Medium
214802
- Large
214803
- Spare diaphragm, small
214810
- Spare diaphragm, medium
214812
- Spare diaphragm, large
214813

VET Eickemeyer®

Large variety of surgery-
and examination tables

SMALL ANIMAL ANAESTHESIA MASKS

- durable clear plexiglass
- with rubber diaphragms
- excellent seal

Size 1, D = 47mm, ID = 25mm

214901

Size 2, D = 57mm, ID = 33mm

214902

Size 3, D = 63mm, ID = 40mm

214903

Size 4, D = 90mm, ID = 38mm

214904

Size 5, D = 135mm, ID = 72mm

214905

Spare diaphragm, size 1

214911

Spare diaphragm, size 2

214912

Spare diaphragm, size 3

214913

Spare diaphragm, size 4

214914

Spare diaphragm, size 5

214915



VET Eickemeyer®

Visit us on our website
www.eickemeyer.de

REBREATHING BAGS

- black rubber
- with hang up hook for drying
- antistatic

0.5 litre

215005

0.75 litre

215007

1.0 litre

215010

1.5 litre

215015

2.0 litre

215020

3.0 litre

215030

4.0 litre

215040

5.0 litre

215050

15.0 litre, for foals, w/o hang up hook

215115

30.0 litre, for horses, w/o hang up hook

215130



Anesthesia accessories, Anaesthetic Set, ULMER Fixator



ANAESTHESIA ACCESSORIES

Transparent parallel breathing circuit with Y-Piece and female ends (ID = 22mm)

212718

Rubber tube for patients less than 7kg (ID = 15mm)

212805

Rubber tube, length = 1m, diameter = 22mm, for small animal circuit

215507

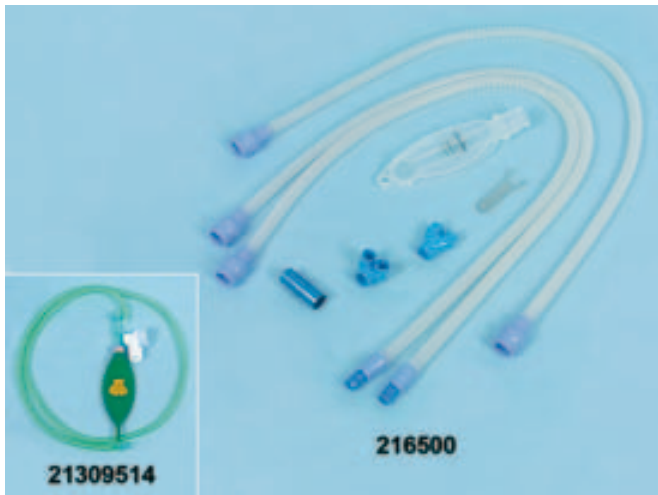

ANAESTHESIA ACCESSORIES

ULMER Anaesthetic Set for small animals, made of SILKOMED

216500

Mapleson Bain Circuit (open system) for patients less than 7kg.)

Complete with 0.5 l breathing bag, pop-off valve, connector to anaesthesia machine

21309514



ANAESTHETIC SET FOR SMALL ANIMALS

AYRES-T-PIECE for small animals up to 7kg

- connect to standard anaesthetic systems

- open circuit

- low resistance

216000



ULMER FIXATOR

Supporting device for breathing tubes

Perfect for fixing tubes, cables of monitors and electrosurgical devices

215300

Anaesthetic System NarkoPet, Rebreathing Bags, Soda Lime

ANAESTHETIC SYSTEM NARKOPET

Anaesthetic Tube, small, additional for Set
214630
- dimensions: D = 90x170mm
214632



REBREATHING BAG COMBIBAG

Necessary in every clinic
- from 500ml (for cats and small dogs) up to
1200ml breathing volume
- critical care ventilation
- with pressure control valve
- autoclavable
215160



SODA LIME

Changes colour from white to violet as soda
lime is exhausted

5.0 ltr. canister
215205



Pulsoxymeter



PULSOXYMETER OXYVET EASY

- mobile, battery operated unit
- large LCD-screen
- Pulsrange from 25–254 bpm
- complete with tongue clip sensor
- optional PC transfer kit

321600

Data-Management-Kit for 321600 and 321650
(software CD and connecting cable)

321654

Tongue clip sensor for 321600, 321650, 321810
321651



PULSOXYMETER OXYVET EASY PLUS

- high resolution colour LCD-screen
- large, easy to read LCD display with SPO₂,
Heartrate and Pulse strength
- user selectable alarm limits
- adjustable alarm volume
- battery operated (up to 36 hrs)
- including tongue clip sensor
- infrared PC-connection optional
- puls range 18–300 bpm

321650

Rechargeable battery for 321650

321652

Charger base for 321652

321653

PULSOXYMETER OXYVET DIGITAL

Mobile hand-held unit with rechargeable battery

- large LED display for both pulse rate and SpO₂
- pulse range 20–350 bpm
- infinitely adjustable high and low alarms for pulse and SpO₂
- digital processing to eliminate most interference e.g. tremors, shaking etc.
- with 2 sensors: lingual clip and rectal sensor
- controls and displays designed for simplicity and ease of use

321408



321408

COMBINED PULS-OXYMETER AND ECG OXYVET-CARDIO

Including respiration and temperature measurement

- large, easy to read LCD display with SPO₂, Heartrate and Pulse strength, ECG, respiration rate and body temperature
- user selectable alarm limits
- state-of-the-art digital signal processing
- including tongue and tail wrap sensor
- Heartrate from 20 to 350 bpm
- 3 or 5 lead ECG
- Trends signalling for temperature and respiration rate
- battery or mains operated
- compact and lightweight
- printer optional (321802)

321800

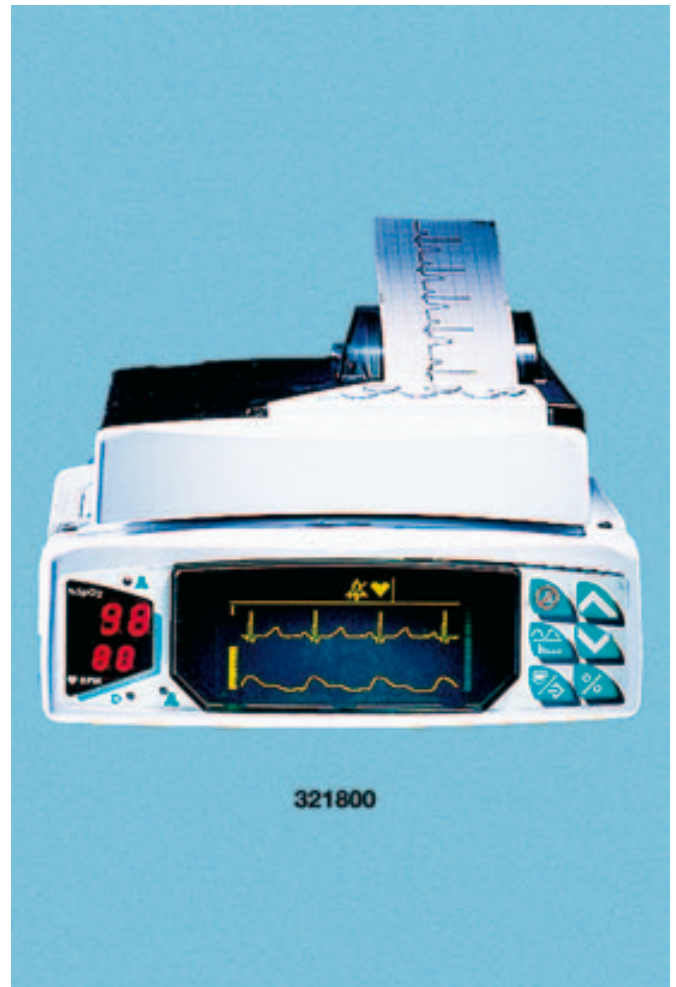

321800

Combined Monitors, Capnometer



OXYVET TEMP

- Combined Monitor for Pulse-Oximetry, Temperature and Respiration Rate
- large and easy to read display showing all parameters
- plethysmographic wave form displayed
- infinite adjustable alarms, audible pulse sound, visual pulse strength bar
- highly compact and portable design
- protective rubber boot
- with lingual clip, rectal sensor, temperature probe and respiratory sensor
- pulse range 20–350 bpm
- mains- or battery powered (mains adaptor included)

321500



COMBINED PULSXOYMETER AND ANAESTHETIC AGENT MONITOR CAPNOVET MULTIAGENT

- large, easy to read LCD display with CO₂, anesthetic agent, exhaled agent and respiration rate
- plethysmographic display of exhaled CO₂
- for Halthan, Isoflurane, Sevoflurane
- patented side stream technology
- user selectable alarm limits

321400

State of the art continuing education centre in Tuttlingen, Germany



Since 1985 almost 10.000 veterinary professionals from all over the world have attended our courses.



Theory lectures, practical demonstrations and hands-on veterinary seminars in full operating theatre facilities provide the maximum learning in the minimum time.



321390

CAPNOVET PRO

Combined Capnometer and Digital Pulse-Oximeter

- specifically developed software for veterinary applications
- easy-to-read back-lit LCD display shows heart rate, respiration rate, inspired CO₂, ETCO₂ and SpO₂
- infinitely adjustable visual and auditory alarms
- provides wave forms, numeric values and on-screen trending
- sidestream technology accommodates intubated and non-intubated patients
- incl. tongue clip sensor
- protective rubber boot
- battery operated
- lightweight, only 630g
- optional: spare battery (No. 32139001) and mains adaptor (No. 32139002)

321390

Rechargeable battery for CAPNOVET PRO

32139001

Charger base for 32139001

32139003

Moisture-Trap for CAPNOVET PLUS, 5/box

E32170001

Combined Monitors



CAPNOVET PLUS

Combined Pulse Oximeter and Capnometer with high resolution vacuum fluorescent display and lingual clip and rectal sensor. The CAPNOVET PLUS offers crisp, clear waveforms with large numerics for maximum visibility. With the optional addition of pulse oximetry and FiO_2 , the lightweight, portable CAPNOVET PLUS has the flexibility to meet the needs of today's demanding environments

- intelligent capnography
- simplified menu structure
- monitoring of both intubated and non-intubated patients of all sizes due to sidestream technology
- patented moisture removal system
- pulse rate: 20–350 bpm
- SpO_2 range: 0–100%

321700

Sample line, length = 1.2m, 10/box

321377

Sample line, length = 2.4m, 10/box

321378

Connector-Set for small animals with Luer

- for tracheotubes with ID = 2/2.5/3/3.5/4mm

321382

CO_2 Absorber for CAPNOVET-PLUS 2/box

E32170002

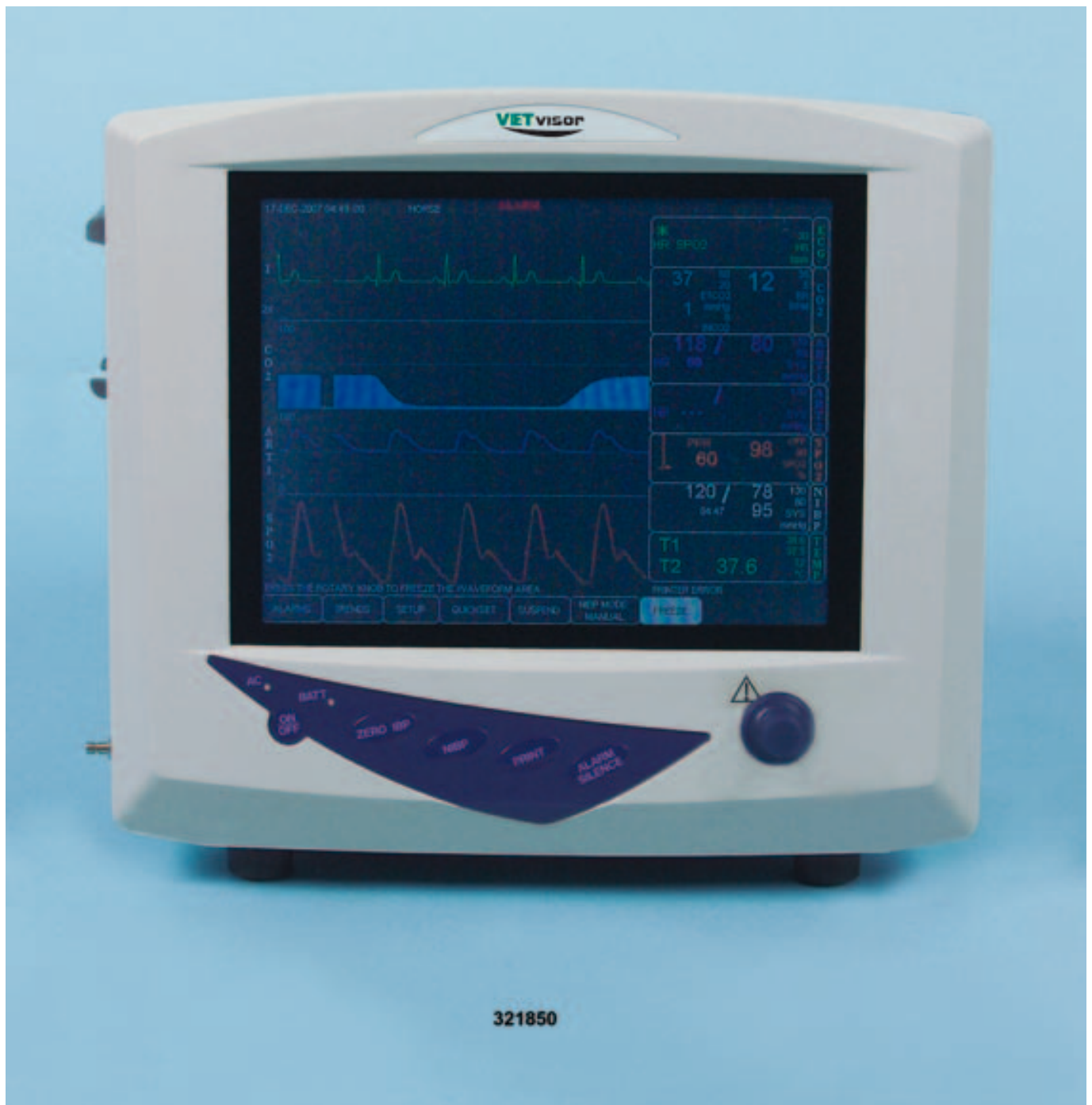

HIGH END MULTI-PARAMETER-MONITOR VETVISOR

VetVisor light

321840

Combines ECG, invasive and non-invasive blood pressure, temperature, CO₂, SpO₂, heart and respiration rate

- End Tidal CO₂ with sidestream technology (also suitable for small animals)
- displays plethysmographic wave form of end tidal CO₂ values
- digital SpO₂ especially developed for veterinary use
- 3/5 lead ECG with display of the heart rate, dual temperature and respiration rate
- invasive and non-invasive blood pressure
- on-screen trending of all monitored parameters
- intuitive point and click user-interface
- data storage via flash-card possible
- 4-trace, 10.4" active matrix colour TFT display, built-in printer
- user selectable alarm limits all parameters
- mains or battery powered
- network compatible
- integrated handle enhances portability
- compact dimensions: 340x310x180mm, weight = 6.8kg

321850

Paper for printer 4/box

321855

Sensors for Pulse Oximeters, Anaesthesia Monitoring

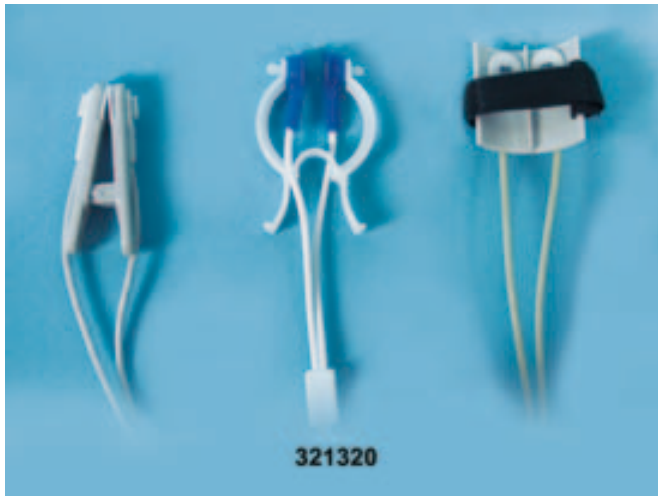

SENSORS FOR PULSE OXIMETER

- especially designed for veterinary use
- fits all animals
- fits on 321408, 321800, 321500, 321400, 321390, 321700, 321850, 321860

Lingual Sensor

321330

Nasal C-Sensor, small, for foals

321320

Tail-Wrap-Sensor

321340



VETVISOR EASY

- Multi-Parameter-Monitor with ECG, non-invasive blood pressure, pulse-oximetry, Temperature, Respiration Rate
- user selectable alarm limits
 - state-of-the-art digital signal processing
 - Pulse strength indicator
 - 3 channel ECG
 - Temperature
 - Non-invasive blood pressure measurements (3 cuff sizes included)
 - large 8.4" colour display
 - battery or mains operated

321810

- Multi-Parameter-Monitor with ECG, non-invasive Blood pressure, Pulsoxymetry, Temperature, Respiration Rate
- user selectable alarm limits
 - state-of-the-art digital signal processing
 - Pulse strength indicator
 - 3 channel ECG
 - Temperature
 - Non-invasive blood pressure measurement (3 cuff sizes included)
 - large 8.4" colour display
 - battery or mains operated

321810V110

RESPIRATORY MONITOR RESPIVET

With new improved charging system,
SWIVEL Connector and Sensor

- indicates reliable apnea
 - sensor is placed inside the anaesthetic circuit
 - sterile
 - alarmstop with photo eye (no contact)
 - compact
 - long lasting battery
 - displays when battery is low
- 217100**



217100

AUDIO PATIENT MONITOR

Audio patient monitor with oesophagus
stethoscope to monitor heart- and respiration
sounds

- easy and reliable monitoring
- includes 3 Oesophageal stethoscopes
(D = 4/6/8mm)
- battery or mains operated

217600

Oesophageal Stethoscope D = 4mm, CH 12

217604

Oesophageal Stethoscope D = 6mm, CH 12

217606

Oesophageal Stethoscope D = 8mm, CH 24

217608



217600

Ultrasonic Doppler, Blowtube Systems



ULTRASONIC DOPPLER BLOOD FLOW DETECTOR

- Reliable and precise non invasive blood pressure measuring for small animals
- acoustical monitoring of blood flow during anaesthesia
- place probe over peripheral artery

Ultrasonic Doppler 811B, with Probe and Charger

217300

Sphygmomanometer with two Cuffs (width = 5.0cm and 7.5cm) for small animals

- in application with Doppler 217300

217301
Blood Pressure Cuff, width = 1.9cm, for small cats

not illustrated

217307

Blood Pressure Cuff, width = 3.3cm, for cats and small dogs

not illustrated

217308

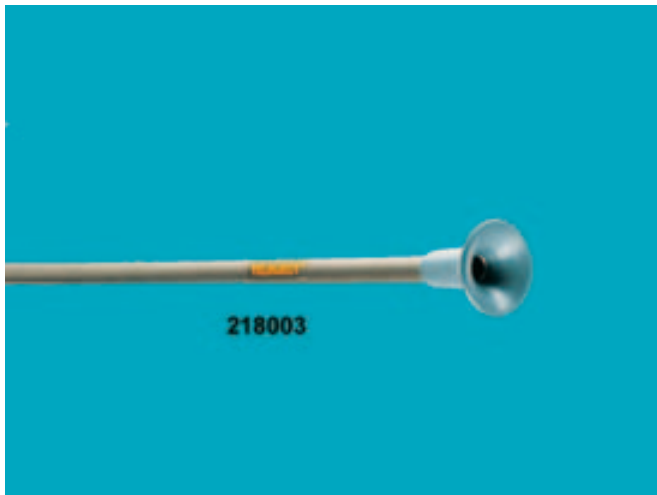

TELINJECT BLOWTUBES

- including 10 syringes, 3.0ml, with needle 1.1x38mm
- with mouth piece

Blowtubes Set, length = 1m, distance = 5m

218003

Blowtubes Set, length = 2x1m, distance = 12m

218103

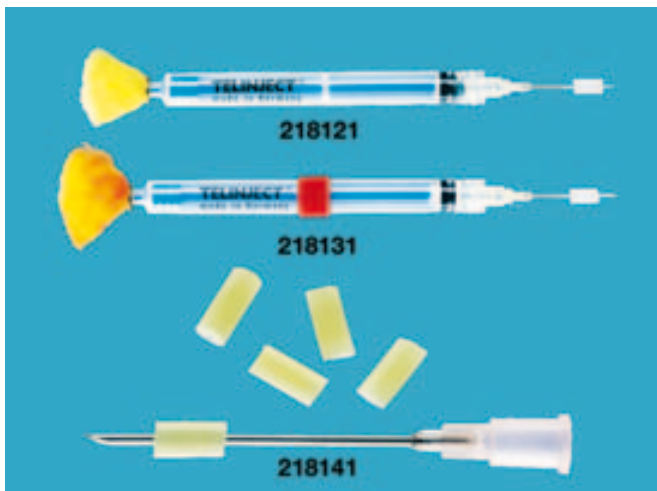

SYRINGES AND NEEDLES FOR TELINJECT BLOW TUBE SYSTEM

Lightweight syringe, 2ml, w/o needle (yellow)

218121

Lightweight syringe 3ml, w/o needle (orange)

218131

Needle for blowtubes, 0.9x25mm

218140

Needle for blowtubes, 1.1x30mm

218138

Needle for blowtubes, 1.1x38mm

218141

Needle for blowtubes, 1.2x38mm

218142

TELINJECT BLOWGUN VARIO

For large animals

- lightweight
- distance up to 25m
- easy targeting
- including pump

218200



SYRINGES AND NEEDLES FOR TELINJECT BLOWGUN VARIO

Syringe 3ml, w/o needle (red)

218204

Needle, 1.5x30mm

218205

Needle, 1.5x38mm

218206

Needle, 1.5x38mm

218207

VARIO-Kit, incl. 10 syringes, needles and accessories

218210

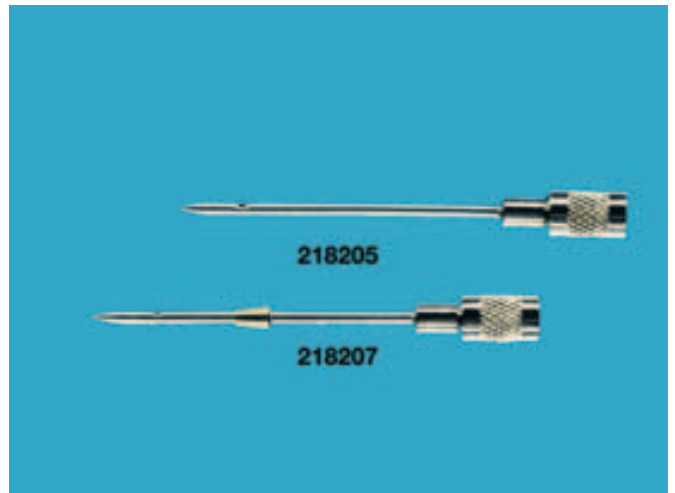

PROFESSIONAL-INHALATION SYSTEM FOR HORSES

Ultrasonic-Inhalator "Air-one"

- high nebulisation
- clear mask
- easy application of the mask
- compact and sturdy housing
- removable valves
- incl. wall mount

219270

INHALATION MASK FOR HORSES

Heavy duty transparent plastic

small

219251

medium

not illustrated

219254

large

not illustrated

219256



Collars, Rack for Collars, Plexiglas Collars



BUSTER CLIC COLLAR

- fully transparent material allows all-round vision
- soft and flexible
- improved quick and simple closing system
- 10/box

5cm for rodents

220105

7.5cm

220107

10cm

220110

12.5cm

220112

15cm

220115

20cm

220120

25cm

220125

30cm

220130

40cm

220140

Combi pack with 20 pcs, includes: 2x7.5 / 3x10 / 3x12.5 / 3x15 / 3x20 / 3x25 / 3x30cm

220190

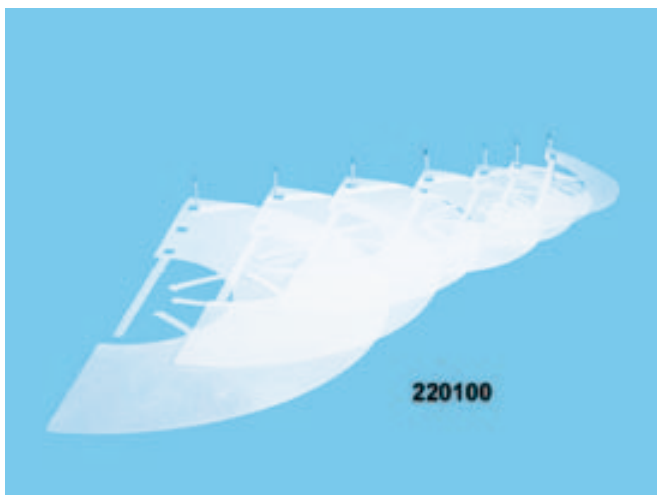

STAINLESS STEEL RACK FOR COLLARS

For orderly storage of the collars according to size

220100

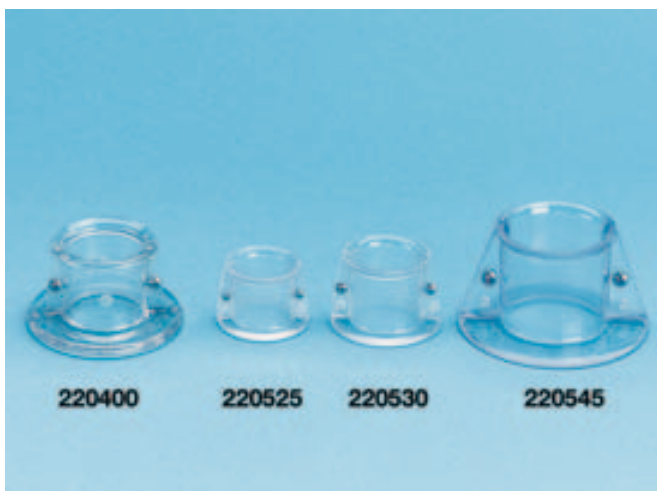

PLEXIGLAS COLLARS FOR PARROTS

- sturdy plexiglas construction
- protect wounds
- easy to apply
- long lasting

For grey parrots, ID = 35mm, height = 4cm

220400

For parrots, ID = 25mm, height = 3cm

220525

For parrots, ID = 30mm, height = 3.5cm

220530

For macow parrots, ID = 45mm, height = 5cm

220545

Bird Collars, Equine Neck Cradle, Battery Handles, Rechargeable Handle

BIRD COLLARS

Prevents the bird from picking feathers and wounds

- easy to apply
- set of 15pcs, includes:
5x8cm, 5x10cm, 3x14cm and 2x20cm

220215



NECK CRADLE

For horses, wooden

- restrains and protects the horse
- easy to apply

222000



HEINE RECHARGEABLE HANDLE SYSTEM BETA NT

HEINE NT 200 Charger for two Handles

- for all HEINE rechargeable handles
- constant automatic charging
- reduced charging time, increased battery life
- cannot be over-charged
- w/o handle

302500

HEINE BETA NT 3.5V Rechargeable Handle

302535

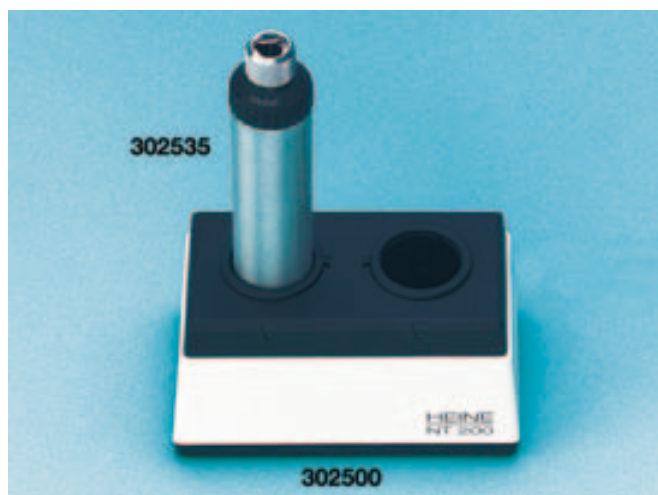

RECHARGEABLE HANDLE HEINE BETA R 3.5V

- ideal for outdoor practice
- can be charged on any wall outlet

302635

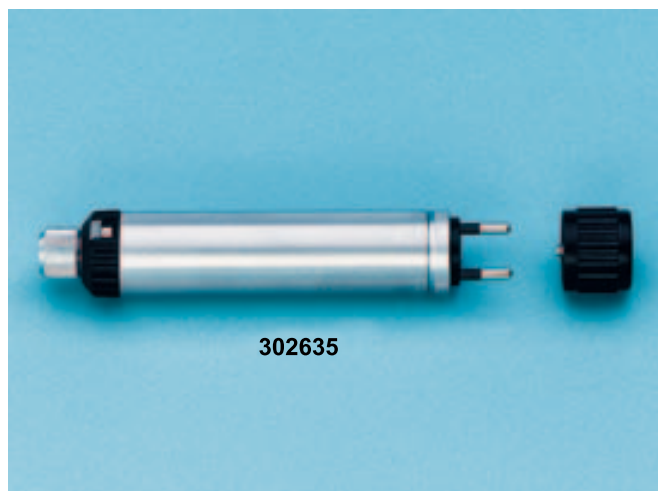

Battery Handles, Slit Illumination Head, Speculas



HEINE BATTERY HANDLE MODULES

Handle module for BETA handle system

302400

Extension for Beta handle module to convert in 3.5V handle

not illustrated

302405

Bottom insert for battery handle module (2.5V), *not illustrated*

302425

Bottom insert for battery handle module (3.5V)

302435

Battery for BETA NT 3.5V handle

302436

Long-lasting lithium ion rechargeable battery for BETA NT 3.5V handle

- continuous use up to 120 minutes

302437

Bottom insert to charge directly on every 220V wall outlet

302637

VET Eickemeyer®

Visit our Online-Shop
www.eickemeyer.de



HEINE SLIT ILLUMINATION HEAD

Ideal for catheterisation, foreign body removal, etc.

- solid metal construction

- 3.5V fiber optic illumination

- multi-coated, scratch-resistant swivel lens with 2x magnification

- double bayonet lock for specula

300035

Spare Swivel Lens with 2x magnification

300080



VETERINARY SPECULA, SANALON

- light weight, very durable

- easy to clean with standard germicides

- long-lasting, positive fit to the otoscope

- fits to Slit Illumination Head No. 300035

D = 2.2 x40mm

300122

D = 2.8 x40mm

300128

D = 3.5 x40mm

300135

D = 4.5 x40mm

300145

D = 5.5 x40mm

300155

Set of 5 pieces

300160

Speculas, Vaginal Specula, Spreadable Specula, Otoscope Set

VETERINARY SPECULA, METAL

- satin finished metal
- sturdy, virtually unbreakable

D = 4x 57mm

300357

D = 6x 65mm

300365

D = 7x 90mm

300390

D = 10x 150mm

300395

D = 6x 65mm, slitted

300460

D = 7x 90mm, slitted

300470

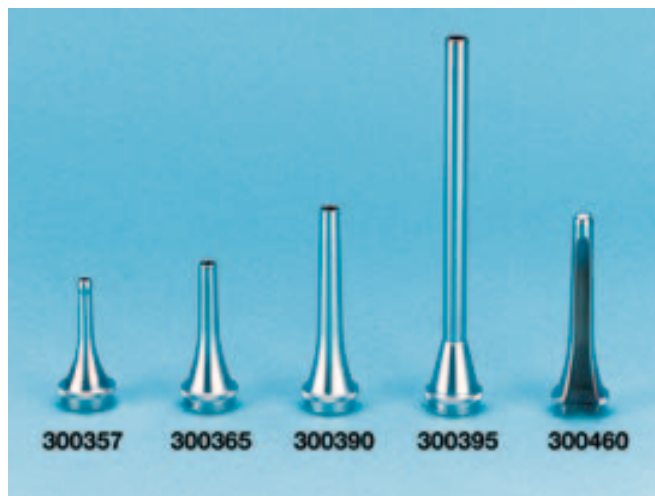

CANINE VAGINOSCOPE HANNOVER TYPE

- ideal for uterine culture swab
- with blunt trocar
- fits to Slit Illumination Head No. 300035

Set of 3 pieces (D = 8, 10 and 15mm)

300403

D = 8mm

300408

D = 10mm

300410

D = 15mm

300415

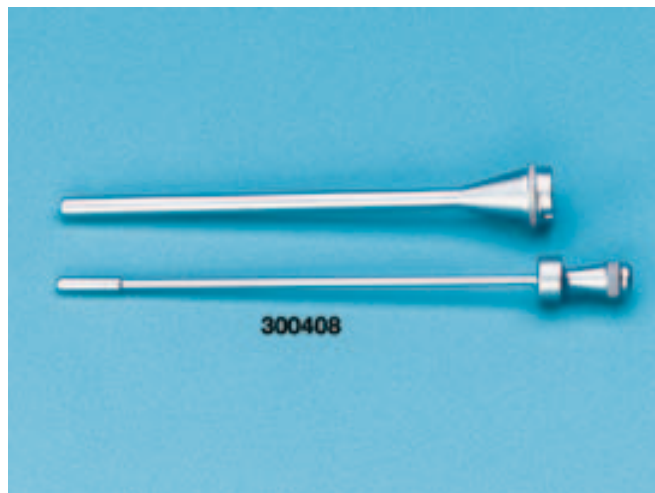

SPREADABLE SPECULA

60mm, extra small specially designed to remove foreign bodies from ears

- fits to Slit Illumination Head No. 300035

300501

100mm, for general examination, also usable as a vaginoscope

- with ratchet and spring
- fits to Slit Illumination Head No. 300035

not illustrated

300502



OTOSCOPE SET ECONOMY

For daily use, contains:

- handle with 2 batteries
- otoscope head
- 3 specula's with D = 0.4 / 0.5 / 0.6mm, length = 4.5cm
- best price performance

300551



Otoscope Head, Veterinary Diagnostic Set, Vaginoscopes

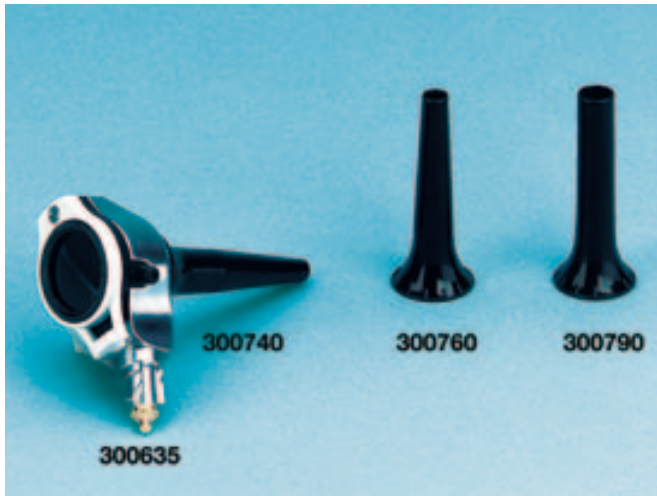

HEINE BETA 200 VET OTOSCOPE HEAD

- 3.5V fiber optic illumination
- large, scratch-resistant, swivelling glass viewing window with 3x magnification
- durable metal body, matte chrome-plated
- reusable Sanalon specula

300635

Veterinary long speculum,
D = 4 length: = 61mm

300740

Veterinary long speculum, D = 6 length = 61mm

300760

Veterinary long speculum, D = 9, length: 61mm

300790

Set of 3 pieces (D = 4, 6, and 9mm)

300703



VETERINARY DIAGNOSTIC SET

G 150 complete with BETA R 3.5V handle,
rechargeable in every 220V wall outlet

301635

G 150 complete with BETA R 3.5V handle and
battery charger base
not illustrated

301535



VETERINARY DIAGNOSTIC SET

G 148 complete with BETA R 3.5V handle,
rechargeable in every 220V wall outlet

301835

G 148 complete with BETA R 3.5V handle and
battery charger base
not illustrated

301735

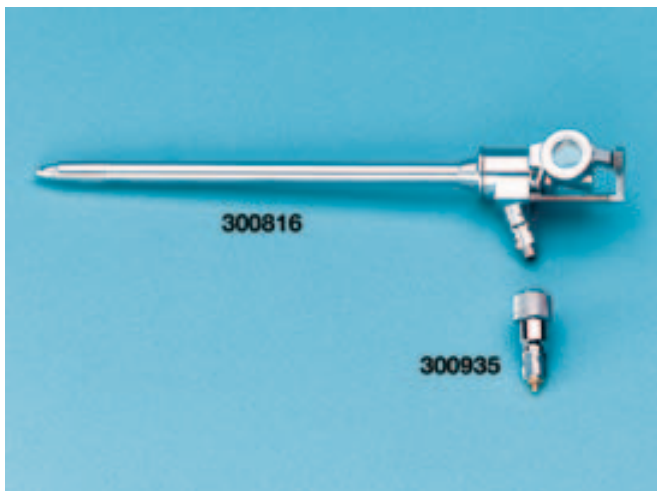

CANINE ENDOSCOPE

Ideal for vaginal and rectal examination, can
also be used as a gastroscope

- brilliant halogen illumination for good visualisation
- with blunt trocar
- can be connected to fibre light cable

D = 11.4 length = 200mm

300811

D = 16 length = 250mm

300816

D = 20 length = 300mm

300820

Adaptor for fibre optic instruments, to connect
with HEINE 3.5V Battery Handles

300935

RIGID ENDOSCOPE FOR SMALL ANIMALS AND HORSES

- precision optic, brilliant colours
- rod lens system
- 30° viewing angle allows greater field of view
- application areas: rhinoscopy, arthroscopy
- soakable
- autoclavable endoscopes on request

D = 1.9mm, length = 10cm, 30° Optic
30421901

D = 2.7mm, length = 11cm, 30° Optic
30432701

D = 2.7mm, length = 18cm, 30° Optic
30422701

Arthroscope for horses, D = 4.0mm, length:
18cm, 30° Optic
304340

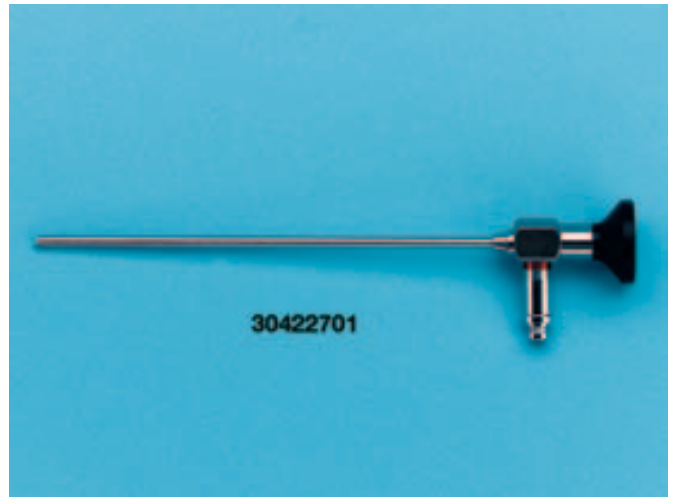

LAPAROSCOPES FOR MINIMAL INVASIVE SURGERY

- E.g. for laparoscopic surgery on bitches
- brilliant colours
 - rod lens system
 - precision optic
 - best visualisation

D = 10mm, length = 33cm, 30° Optic
305000

D = 10mm, length = 66cm, 0° Optic,
- specially for equine use
305010

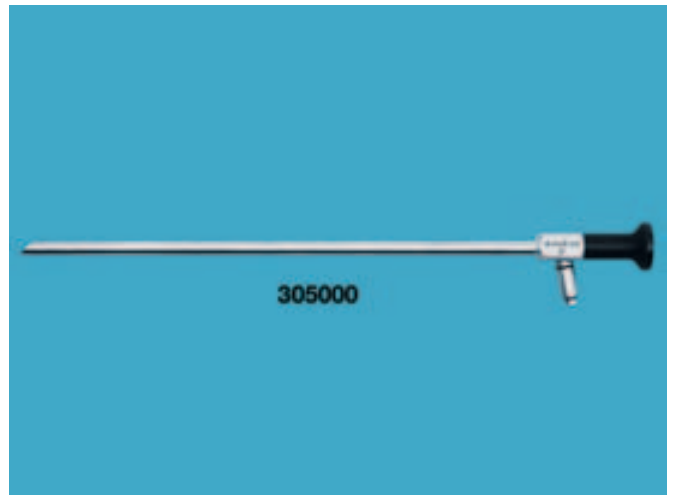

OPERATING SHEATH WITH INSTRUMENT CHANNEL

- with 2 ball valves for suction and flush
- with one blunt trocar
- integrated working channel for flexible forceps up to D = 1.8mm
- ideal for rhinoscopy and otoscopy on cats and dogs

For endoscopes with D = 2.7mm and
length = 11cm
30472802



Otoscope Sheath, Endoscope Sheaths, Arthroscopy Instruments

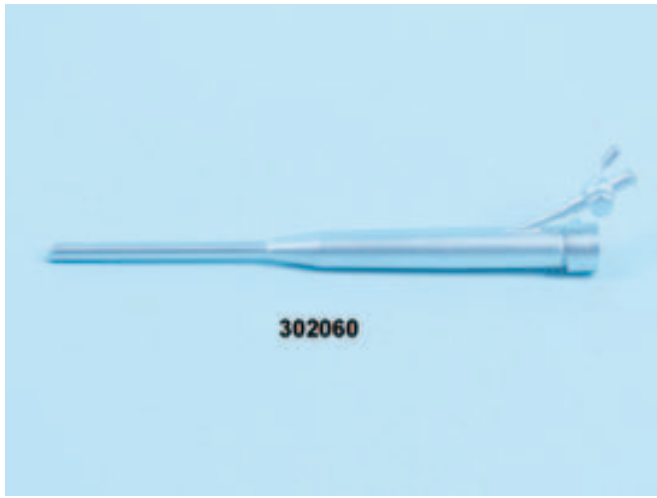

OTOSCOPE SHEATH

- Perfect for examination, removing foreign bodies and taking biopsies
- Luer lock with closure for flushing the ear
- robust and durable
- rounded edges
- with high flow

D = 5mm (distal end), with working channel
D = 2mm, length = 18cm, for rigid endoscope
No. I30422701

302060

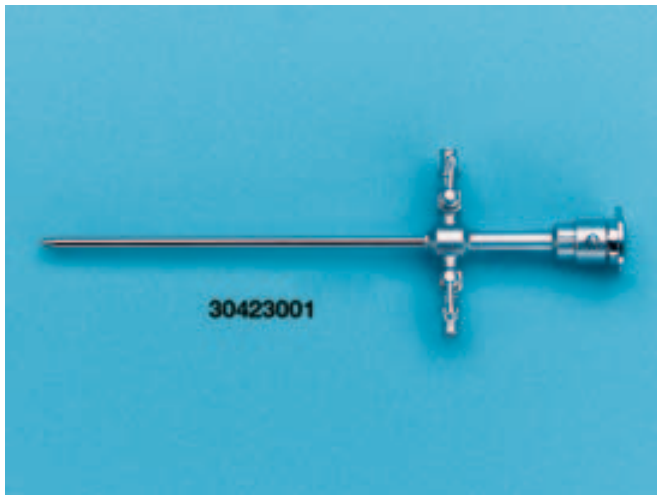

ARTHROSCOPY SHEATHS

- high flow
- with stopcock
- Luer lock
- with one blunt and one sharp trocar

For endoscopes with D = 1.9mm, length = 10cm
30431901

For endoscopes with D = 2.7mm, length = 11cm
30433001

For endoscopes with D = 2.7mm, length = 18cm
30423001

For endoscopes with D = 4.0mm, length = 18cm
304345

Instrument-working-sheath, D = 5.5mm

- easy to use
 - for arthroscopic procedures
 - protects your endoscope
- not illustrated*

304732

VET Eickemeyer®

Our service – Your benefit

Our skilled instrument makers can fully inspect your instruments and take the necessary steps to return them to an excellent working condition.



ARTHROSCOPY INSTRUMENTS

Spoon Forceps, OD = 2.7mm, working length: 12.5cm

304742

Hook Scissors, OD = 5mm, straight, working length = 13cm

304743

Universal Grasping Forceps, OD = 2.7mm, working length = 12cm

304745

Biopsy Forceps, D = 3.4mm, working length = 13cm, handle with ratchet

304515

ARTHROSCOPY INSTRUMENTS

Fits through instrument working channel

Hook, 2mm

304755

Curette with round hole, delicate

304759

Curette, delicate

304758

Circular knife, straight, 3.5mm

304536

Knife for endoscopy, extremely sharp

304756

Knife, double-edged, very sharp

304757

Elevator, 2.8mm

304761

Meniscus knife

304760

Hook knife

304762

Knife, retrograde, very sharp

304738

Hand milling cutter

304744

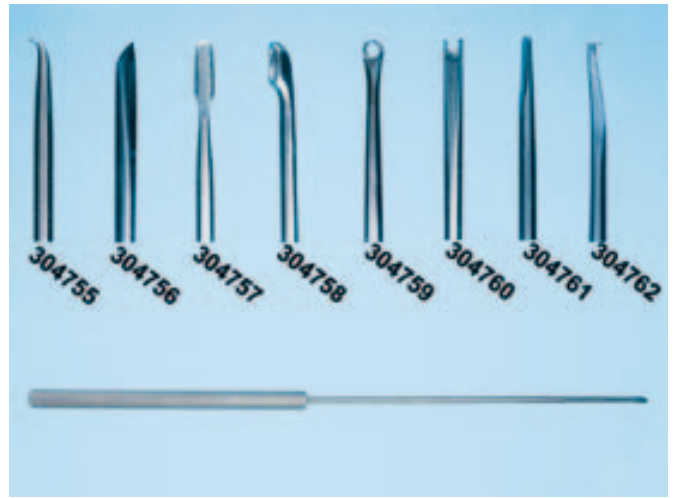

SUCTION- AND IRRIGATION PUMP MIC

Pump for silicone tube, with foot switch, demonstration model

305150

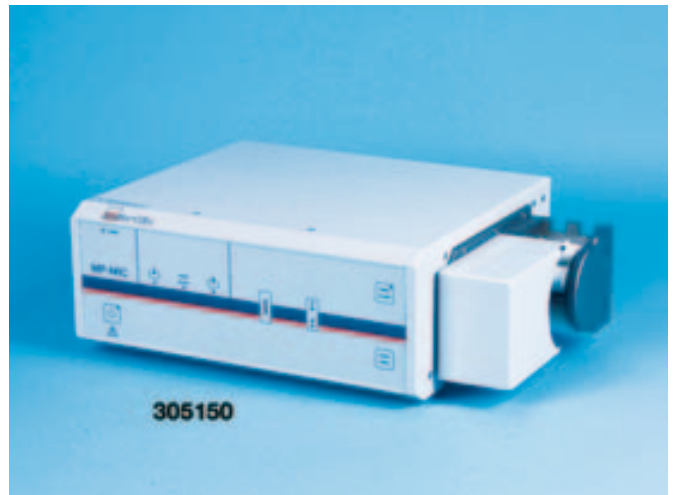

ARTHROSCOPY INSTRUMENTS FOR HORSES

Extra strong sheaths guarantees the long life for your instruments.

- Length = 23 cm

Hook and retractor, 3.5mm

304535

Chisel, straight, 4mm

304564

Chisel, 6mm

304563

Special knife, heavy model

304561

Elevator, curved, 6mm

304562

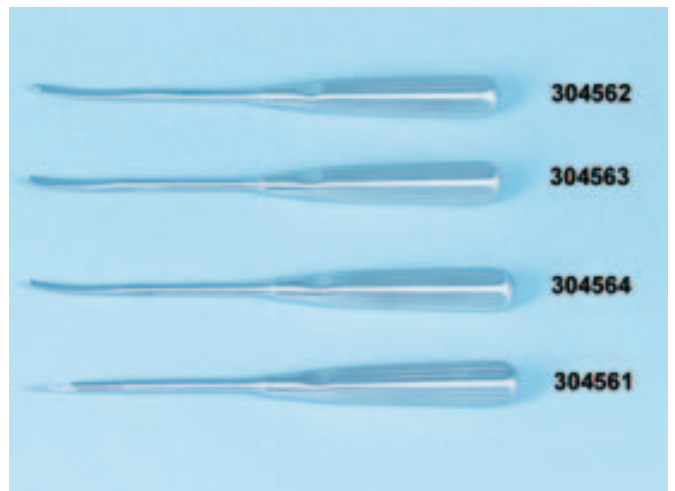

Arthroscopy Instruments, Pressure Infusor, Rigid Endoscopes



ARTHROSCOPY CURETTES FOR HORSES

Extra strong sheaths guarantees the long life for your instruments.

Length = 23.5 cm

Suction curette, straight, oval spoon
6.5x3.8mm, with suction hole (Luer lock)

304565

Suction curette, straight, oval spoon,
5.0x2.8mm, with suction hole (Luer lock)

304566

Spoon, oval, 3.0x2.0mm

304567

Spoon, oval, 5.0x3.0mm

304568

Spoon, oval, 7.0x5.0mm

304569

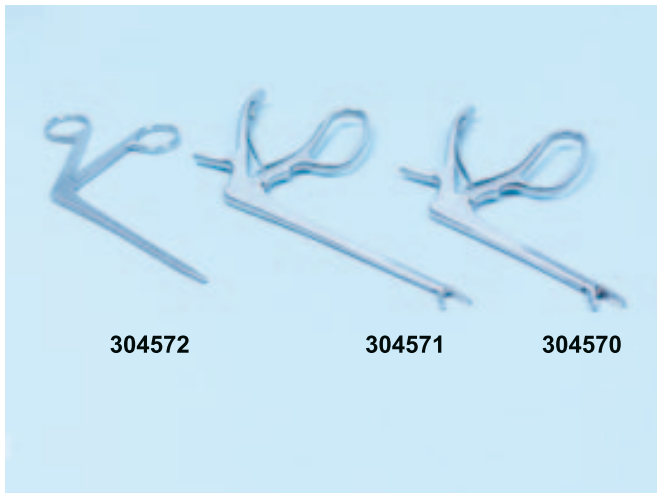

ARTHROSCOPY RONGEURS FOR HORSES

Extra strong

Hook scissors 4x10mm, length = 150mm, very sturdy

304574

Rongeur, 3x10mm, length = 180mm, very sturdy

304570

Rongeur, 5x10mm, length = 140mm, very sturdy

304571

WAGNER modified, heavy model, shaft-length = 9cm, mouth 5x7mm

184705

Rongeur "Chip-Remover", 5x15mm, length = 12cm, with teeth

304572



PRESSURE INFUSION CUFFS

For Veterinary Arthroscopy

- with pressure gauge
- for collapsible IV bags
- IV bag fits inside mesh and nylon bag

For infusion bag 500–1000ml, with hand pump

402040

For infusion bag 3000ml, with hand pump

402043

For infusion bag 3000ml, with foot pump

402045

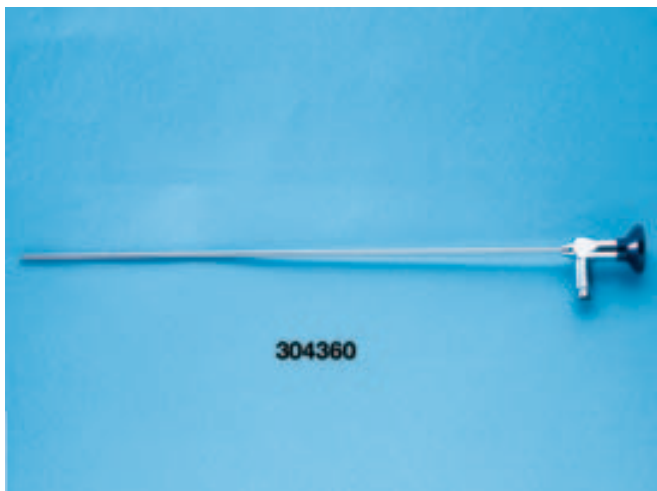

RIGID ENDOSCOPE

Especially designed for artificial inseminating bitches

D = 4mm, length = 36cm, 30° optic

304360

Sheath, Pressure Infusor, Inflow Cannula, Sheaths and Trocars

SHEATH WITH ALBARRAN STEERING ARM

For Endoscope No. 304360

- with working channel
- with two cocks
- with one blunt and one sharp trocar

304365

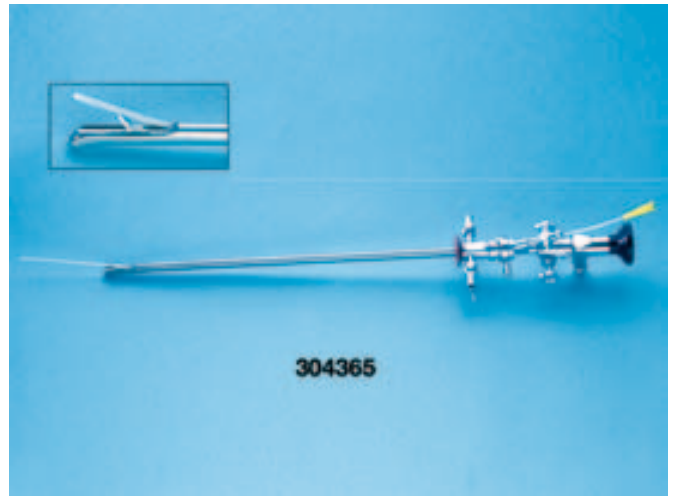

CO₂ / PRESSURE INFUSOR

Ideal for the CO₂ and/or supply of liquid during endoscopic and arthroscopic surgery for better illustration e.g. large joints with synoviti

- up to 300mm Hg pressure
- automatic pressure control
- easy to operate
- reliable

304573



INFLOW CANNULA WITH SHARP TROCAR

- with stopcock
- for irrigation of joints

D = 3.2mm, length = 7cm

304532

D = 4.5mm, length = 7cm

304545

Silicon tube, length = 2m

not illustrated

304645

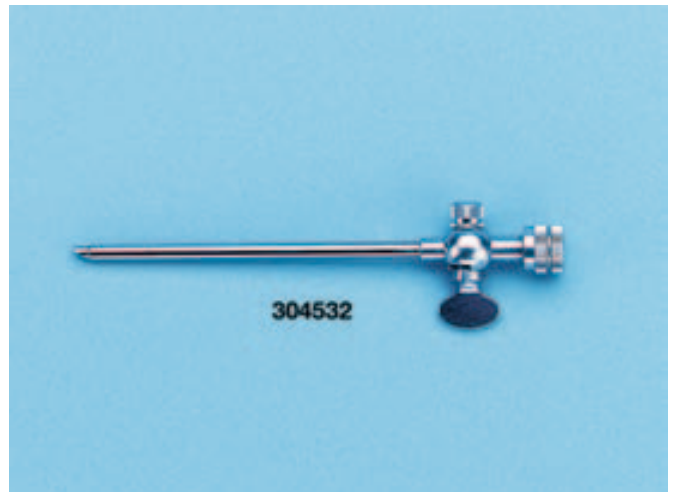

AUTOMATIC-TROCAR SHEATHS WITH STOPCOCK

- automatic closure after removing the trocar
- trocar pin with pyramidal tip

ID = 5mm, with stopcock and pin

- for laparoscopes and instruments up to D = 5mm

305021

ID = 10mm, with stopcock and pin

- for laparoscopes and instruments up to D = 10mm

305020

Reduction piece, plastic, from 10 to 5mm, for No. 305020

305019



Sheaths and Trocars, Laparoscopy Instruments, CO₂-Insufflator



SAFETY ENDOSCOPE SHEATHS

Automatic protection of the sharp tip after foramination of the abdominal wall

- with valve
- Luer lock connection
- with one blunt and one sharp trocar

ID = 5mm, with stopcock and pin

305023

ID = 10mm, with stopcock and pin

305022

Reduction piece for safety trocar, from 10 to 5mm

- for No. 305022

305024



LAPAROSCOPIC INSTRUMENTS

Tissue forceps, ratchet, D = 5.0mm, length = 33cm

305015

Tissue forceps for threads (MARYLAND-Dissector), ratchet, D = 5.0mm, length = 33cm

305025

METZENBAUM scissor with ratchet, D = 5.0mm, length = 33cm

305035

Hook scissors, D = 5.0mm, length = 33cm, w/o ratchet

305030

METZENBAUM scissor with ratchet, curved, D = 5.0mm, length = 33cm, handle insulated

305036

Biopsy forceps with ratchet, D = 5.0cm, length = 33cm

305039

Knot Guide

305040



CO₂-INSUFFLATOR

Incl. pressure-tube and insuflation-tube

- automatic gas flow adjustment
- constant intra-abdominal pressure
- pressure pre-selection 4–25mm Hg

305250

Cylinder Attachment fits for 0.75 l CO₂-Cylinder
not illustrated

305202

CO₂-Cylinder 0.75l
not illustrated

305207

VERESS pneumoperitoneum needle
D = 2.0mm, length = 100mm, Luer lock
not illustrated

305002

UNIVERSAL FIBRE OPTIC CABLE

- fits on any light source or endoscope with optional adapters
- autoclavable and soakable

3.5×1800mm, grey

306518

3.5×2300mm, grey

306523

4.9×1800mm, grey

Large fibre optic cable offers bright light

306520

3.5×1800mm, grey

Especially for Xenon light source

306525

FIBRE OPTIC CABLE ADAPTORS

Lightsource Channel ,EICKEMEYER‘

306500

Instrument Channel ,EICKEMEYER‘

306800

LIGHT SOURCES VETLUX

VETLUX – 150 Watt bright halogen

- compact halogen light source with variable output
- quiet running
- optional adapters for other manufacturers available
- great value

302950

VETLUX PLUS 150 W bright halogen with air insufflator

- ideal for rigid endoscopes
- automatic air
- optional adapters for other manufacturers available
- great value

302960



Multifunction Videosystem, Light Source, CCD-Cameras

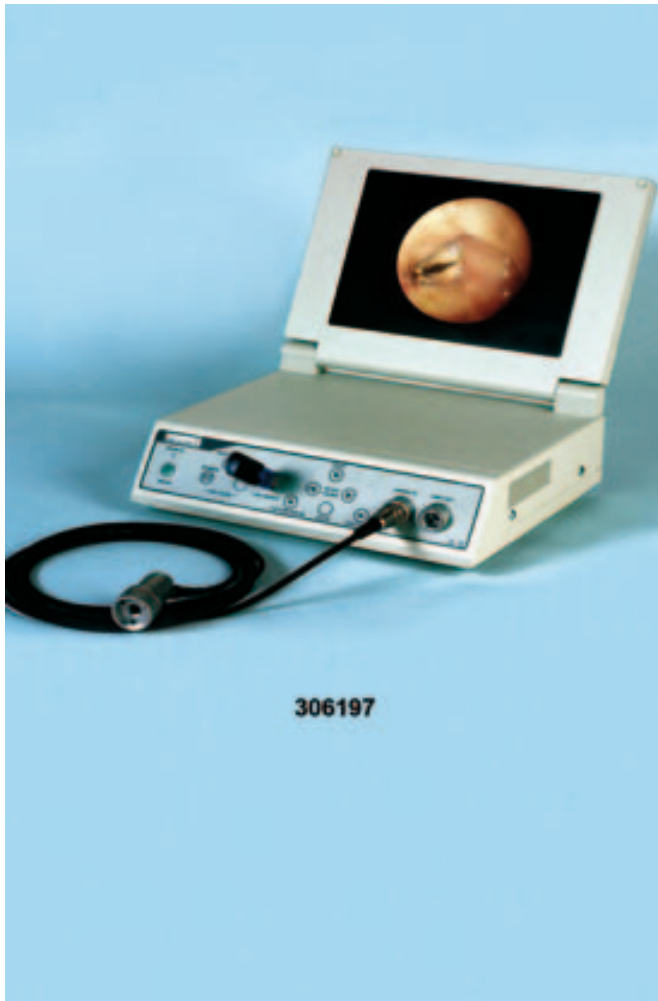

306197

XENON MULTIFUNCTIONAL VIDEOSYSTEM

Multifunction Videosystem with xenon lightsource, 24 Watts

- high resolution CCD color camera
- easy to operate
- large 10.4 " color LCD monitor
- incl. Insufflation pump for flexible endoscopes
- Images can be stored on an USB stick and easily transferred to the PC
- with standard endoscopic coupler
- please indicate Endoscope brand when ordering

306197

Multifunction Videosystem (Motion), see 306197, with video capture capability *not illustrated*

306198



302987

LIGHT SOURCE XENOVET PLUS

180 Watt XENON, with air insufflator for flexible endoscopes

- improved high intensity white light for pure colour reproduction
- automatic air for insufflation
- long-life lamp, easy to change
- for brighter illumination around the peripheral area
- optional adapters for other manufactures available

302987



306180

VET-CCD CAMERA

A high resolution CCD-chip guarantees brilliant, sharp and high clarity pictures

- PAL/NTSC system
- waterproof camera head
- easy handling
- with adaptor for endoscopes with standard optic

306180

VET-CCD PRO CAMERA

incl. endoscope-adaptor

For flexible endoscopes with length of more than 1.50m, incl. endoscope and TV-adaptor

- high resolution CCD-Chip guarantees best pictures
- PAL system
- easy handling with OnScreen-Display
- electric Anti-Moiree-Filter

306182



ENDOSCOPE ADAPTER

C-Mount water resistant

- fits on almost every endoscope

306206



VET Eickemeyer®

Your reliable source for
innovative products

Image Capture System, Lightsource with CCD-Camera



306195

USB BASED IMAGE CAPTURE SYSTEM

- Image digitalisation for Endoscopy, Sonography, Microscopy etc.
- simply connects between camera and monitor
 - foot operated switch takes a full image
 - automatic conversion to a jpeg
 - automatic storing on USB Stick
 - quick and easy transfer to your computer

306195

Type "motion".

Saves analog still- and motion videos
not illustrated

306201

Footswitch for 306201

30620101



306185

CAMLIGHT 150

Powerful light source in combination with a high resolution CCD-Camera

- bright light source (150 W)
- brilliant colours
- compact all in one
- incl. TV-Adaptor
- best value

306185

HIGH RESOLUTION SONY LCD MONITOR

- provides high resolution images
- up to 16.7 Mio colors
- PAL/SECAM/NTSC
- operation settings by using the on-screen menu
- 35cm diagonal diameter

30621003



VIDEO OTOSCOPE

With integrated working channel, endoscope ocular and standard adapter for light source

- to connect to standard CCD-Cameras
- brilliant focusing with variozoom
- can be connected to standard fibre optic cable
- instrument channel for foreign body forceps, irrigation and suction
- working length = 55mm, D = 5mm

302050

Flexible foreign body forceps for video-otoscope, D = 1.8mm, length = 250mm, *not illustrated*

302055

Cleaning brush for video-otoscope *not illustrated*

302056

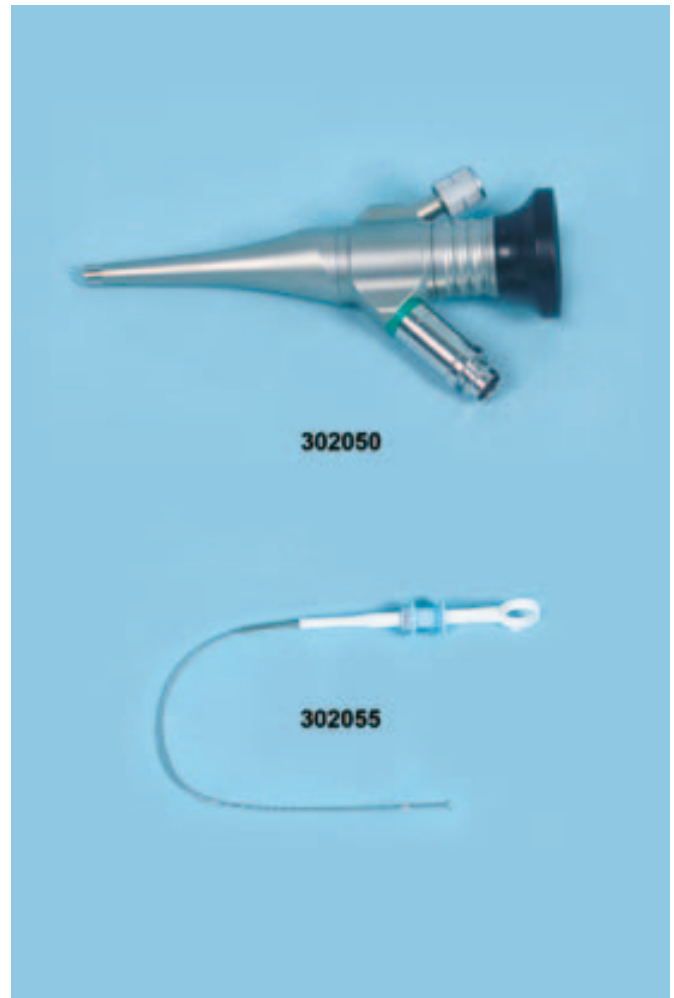

Videoendoscope

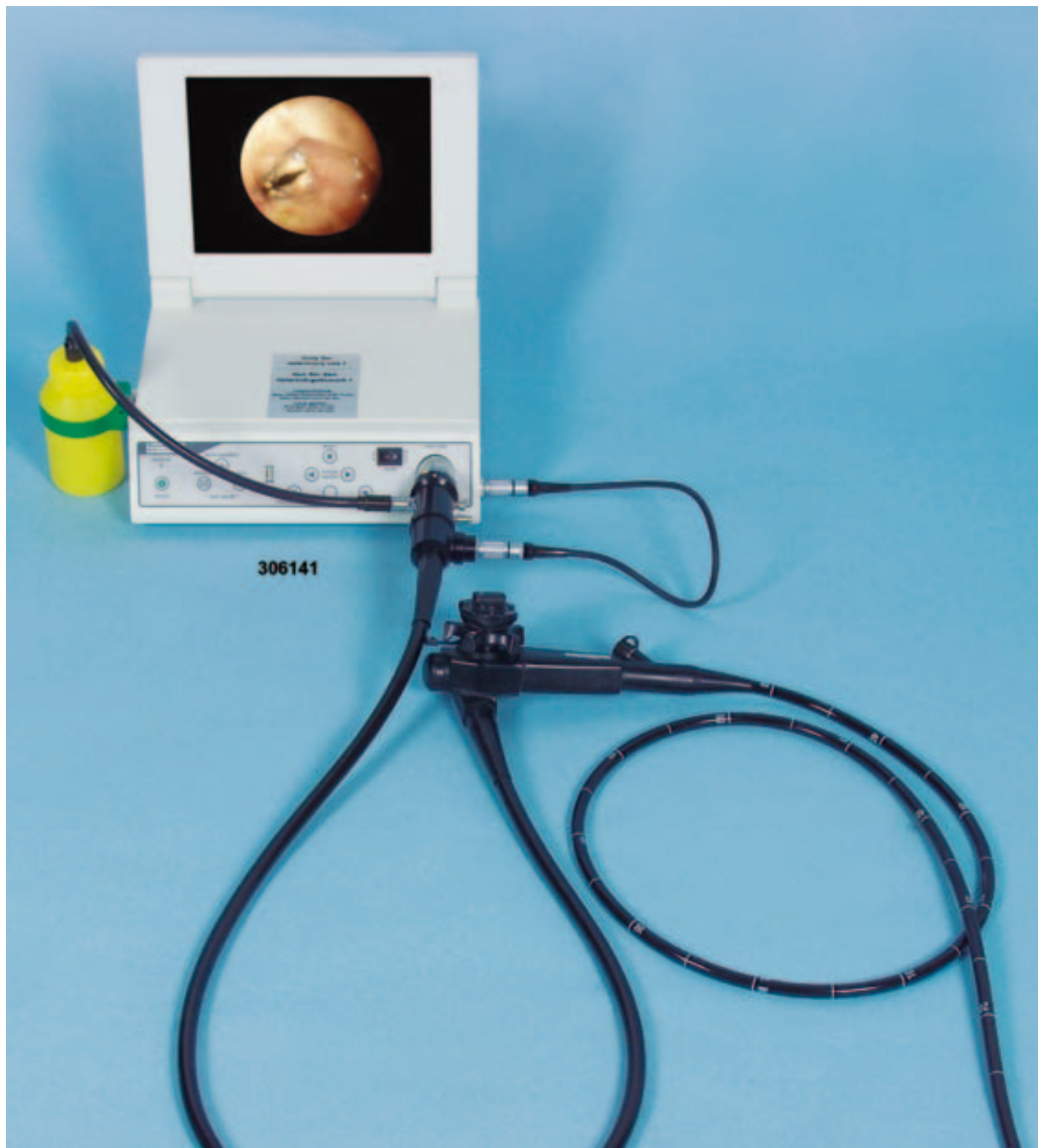

VIDEOENDOSCOPE WITH MULTIFUNCTION-VIDEOSYSTEM

- with Xenon lightsource, 24 Watt
- high resolution ccd colour camera
- large 10.4 " color LCD monitor
- incl. Insufflation pump for flexible endoscopes
- Images can be stored on an USB stick and easily transferred to the PC

OD = 9.5mm, working channel D = 2.8mm, length = 150cm for small animals with multifunction system "still"

306141

OD = 9.5mm, working channel D = 2.8mm, length = 150cm for small animals with multifunction system "motion"

306142

OD = 13mm, working channel D = 3.2mm, length = 300cm for horses with multifunction system "still"

306143

OD = 13mm, working channel D = 3.2mm, length = 300cm for horses with multifunction system "motion"

306144

FLEXIBLE ENDOSCOPE VFS 2A / VFS B

Specially designed for small animals

- shaft length = 100cm
- operating channel: 2.0mm
- including accessories

VFS-2A

- two way end tip deflection, 120° up/down
- shaft diameter: D = 6.4mm
- field of view: 70°

306102

VFS-2B

- end tip deflections 180° up, 120° down/left/right
- shaft diameter: D = 6.6mm
- field of view: 95°

306103

FLEXIBLE ENDOSCOPE VFS-8

For cytoscopy, rhinoscopy and urology

- shaft length = 86cm
- shaft diameter: D = 3.0mm
- field of view 95°
- operating channel: 1.3mm
- with fibre light cable

306108

FLEXIBLE ENDOSCOPES FOR HORSES

Ergonomically designed handle with automatic air, water and suction valves are ergonomically placed for comfortable single handed operation For Bronchoscopy and Gastroscopy

Flexible Endoscope VFS-300







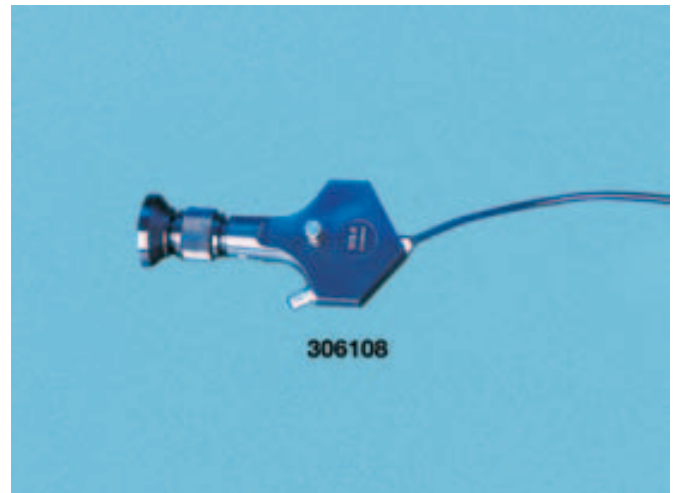

Technical Details:

- shaft length = 300cm
- shaft diameter: D = 9.9mm
- field of view: 100°
- end tip deflection: 180° up/down, 160° right/left
- operating channel: D = 2.8mm

306130



Foreign Body Forceps, Biopsy Forceps, Stone Removal Forceps, Cytology Brush

	Videoendoscope 306147	Videoendoscope 306148	VF 2A/2B 306102/103	VFS-8 306108	VF 300 306130
 Biopsy Forceps	D = 2.4 mm, L = 230 cm 306316	D = 2.4 mm, L = 350 cm 306330	D = 1.8 mm, L = 160 cm 306315	D = 1.0 mm, L = 120 cm 306311	D = 2.4 mm, L = 350 cm 306330
 Biopsy Forceps with trocar	D = 2.4 mm, L = 230 cm 306427	D = 2.4 mm, L = 350 cm 306428	D = 1.8 mm, L = 160 cm 306425		
 Alligator Forceps	D = 2.4 mm, L = 230 cm 306216	D = 2.4 mm, L = 350 cm 306230	D = 1.8 mm, L = 160 cm 306215	D = 1.0 mm, L = 120 cm 306211	D = 2.4 mm, L = 350 cm 306230
 Clamp Alligator Forceps, with 1x2 teeth	D = 2.4 mm, L = 230 cm 306432	D = 2.4 mm, L = 350 cm 306433	D = 1.8 mm, L = 160 cm 306430		
 Gripper with 3 clamps	D = 2.4 mm, L = 230 cm 306343	D = 2.4 mm, L = 350 cm 306344	D = 1.8 mm, L = 160 cm 306341	D = 1.0 mm, L = 120 cm 306340	
 Stone Catcher, 50mm cage, 6 monofilament	D = 2.45 mm, L = 230 cm 306338	D = 2.45 mm, L = 350 cm 306339	D = 1.8 mm, L = 160 cm 306337	D = 1.0 mm, L = 120 cm 306336	D = 2.45 mm, L = 350 cm 306339
 Cytology Brush	D = 2.45 mm, L = 230 cm 306418	D = 2.45 mm, L = 350 cm 306419	D = 1.8 mm, L = 160 cm 306416	D = 1.0 mm, L = 120 cm 306415	
 Polypectomic Mesh	D = 2.45 mm, L = 230 cm 306423	D = 2.45 mm, L = 350 cm 306424	D = 1.8 mm, L = 160 cm 306421	D = 1.0 mm, L = 230 cm 306420	
 Cleaning Brush	D = 1.8 mm, L = 230 cm 306442	D = 1.9 mm, L = 350 cm 306443	D = 1.8 mm, L = 160 cm 306440	D = 1.2 mm, L = 120 cm 306444	D = 1.9 mm, L = 350 cm 306443

SMALL SUCTION PUMP FOR ENDOSCOPY

- 8 l/Min.
- compact
- reliable
- best price performance
306055



STERILE COVER FOR CAMERA

- Pack with 15 pcs
306100



CLOTH COVER FOR CAMERA

- Length = 150cm, autoclavable
306101

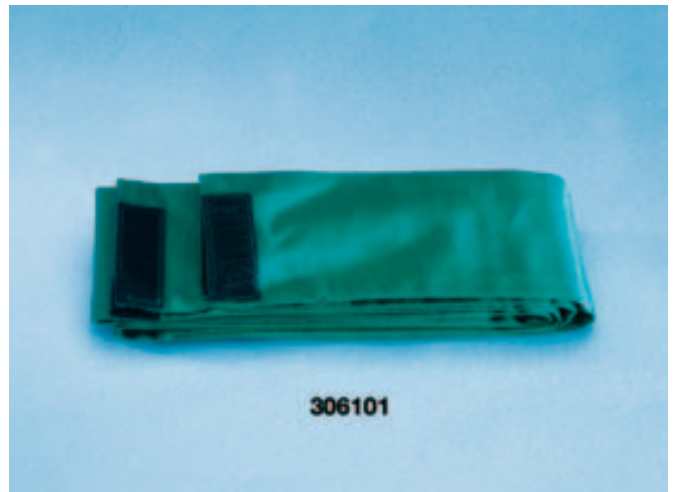

SAMPLE RETRIEVAL TUBE

- with luer tip, 3.5m
- special tube with D = 2mm
- transparent
- fits to major endoscopes with appropriate diameter
306352



Endoscope Cart



ENDOSCOPE CART

- Powder coated steel
- large sized shelves (4 shelves and 1 drawer)
- easy to clean and resistant against disinfectant damage
- height = 143cm
- integrated power supply (in both columns)
- modern design
- 4 swivelling castors
- easy to move
- extremely durable

306150



ENDOSCOPE CART EICKEMEYER

- 3 variable shelves, 54x50cm
- 1 attached shelf
- one additional small shelf for EICKEMEYER TFT-Monitor
- footprint = 70x60cm
- height = 170cm

306155

Handle Set for 306155

306156

Fibre Light Cable / Camera Mount for 306155

306157

STAINLESS STEEL ENDOCART

With height adjustable shelves

- unique design
- mobile with high quality lockable castors
- large sized shelves
- easy height adjustment
- easy to clean
- very durable
- footprint: 60x60cm

306160



ENDOSCOPE CLEANING TUBE

Side mounted on endoscope cart

- pivoted disinfection tube
- with drain cock
- for endoscopes up to 160cm in length
- space for additional 2 foreign body forceps

303980

Wall mounted plexiglas Tube

- for all endoscopes
 - space for additional 2 foreign body forceps
- not illustrated*

303985



ENDOSCOPE CLEANING

Instrument Cleaning Container with Cover and Sieve Tray

307360

Disinfectant GIGA SEPT FF, 2 litre

307315



Ultrasound Machines



ULTRASOUND MACHINE EICKEMEYER MAGIC 1100

Portable Ultrasound Unit for the Equine Practice, including transducer 5.0 MHz and charger.

- picture mode: B, B/B, B/M, M
 - grayscales: 256
 - screen with over 14cm screen diagonal
 - flicker-free SVGA screen for sharp pictures
 - Cine Memory for 64 pictures
 - 8 pictures can be permanently memorised
 - multi-frequency probe connection
 - weight = 4.5kg
 - Dimensions: L = 275 x B = 304x H = 160mm
- 303800**



ULTRASOUND MACHINE EICKEMEYER MAGIC 1000 PLUS

- Scanning Method: Electronic linear
 - Display Modes: B, B+B, B+M, M;
 - Display: 10" non-interlaced monitor
 - Gray Scale: 256
 - Linear rectal probe
 - Transducer Connector: 1
 - Dynamic Imaging Technology:
Digital-Beam foaming (DBF)
 - Cine Loop: 128-frame cine loop memory
 - Storage Media: Internal flash and USB stick
 - Built-in Image Archive: Permanent Storage
up to 90 images
 - Dimensions:
270 mm (H) x 320 mm (L) x 360 mm (W)
 - Weight: 9.5 kg;
- 303810**



303700

ULTRASOUND MACHINE EICKEMEYER MAGIC 5000 DIGITAL

Digital and compact!

- portable unit with exceptional image quality
- fully digital beam-former technology
- ideal for use in the clinic and for outdoor examinations
- image mode: B, B/B, B/M, M
- grey scale: 256 levels
- 10-inch SVGA high resolution monitor
- cine memory of 128 frames
- permanent storage on built-in memory, and USB disk
- Measurements: distance, circumference, area, volume, ratio, angle, histogram, profile
- patient information management
- software package: canine, feline, equine, bovine and ovine
- dimension: H = 680x W = 390xT = 530mm
- weight = 11kg

303700

Trolley for MAGIC 5000 Digital

303705

Carrying bag for MAGIC 5000 Digital

not illustrated

303706

Transducers

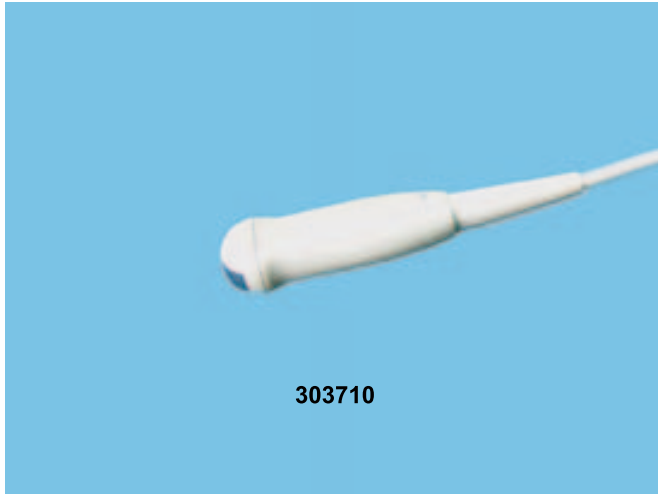

TRANSDUCER

Multifrequency probe 5.0 MHz micro convex for
MAGIC 5000 Digital

- frequency change-over from 5.0/6.5/8.0 MHz
303710



TRANSDUCER

Multifrequency probe 7.5 MHz linear t-shape for
MAGIC 5000 Digital

- frequency change-over from 5.0/7.5/10.0 MHz
303711



TRANSDUCER

Multifrequency probe 5.0 MHz linear rectal for
MAGIC 5000 Digital

- frequency change over from 4.0/5.0/6.5 MHz
303712



COLOUR DOPPLER MAGIC 8000

- Colour doppler technology at b/w prices
- including multifrequency transducer micro-convex (5.0/6.0/8.0 MHz)
- including multifrequency transducer T-shaped (5.0/7.5/10.0 MHz)
- Display Modes: B, B/B, B/M, M, Color mode, PW
- Greyscales: 256
- TGC Control: 8 Steps
- extensive measurement capabilities
- large 14" monitor
- Cine Memory for up to 1024 images
- internal memory, CD RW
- Comprehensive Patient Data Management
- 2 USB Ports, Ethernet port
- Dimensions H = 1250 x W = 630 x T = 1440 mm
- Weight = 135kg

304450

ECG Modul for MAGIC 8000

304451

DICOM Software 3.0 for MAGIC 8000

304452

Cardio package for MAGIC 8000, CW doppler, ECG modul with software and patient cable
not illustrated

304453

Phased Array Cardiology transducer 2.0 / 2.5 / 3.0 / 3.5 / 4.0 MHz

304454

Ultrasound Machines, Transducers



ULTRASOUND MACHINE ALOKA SSD-500

The ALOKA SSD 500 offers high quality resolution for precise diagnosis. An unmatched combination of performance and portability makes the SSD 500 the versatile ultrasound unit for both large and

- image modus: B, B/B, B/M, M
- grey scale: 256
- focus: 4-point-focusing
- probes: linear, micro-convex and convex
- clear flicker free 7" monitor
- dimensions: D = 290 x W = 250 x H = 320mm
- weight = 10kg
- Monitor: 18cm diagonal

303901500

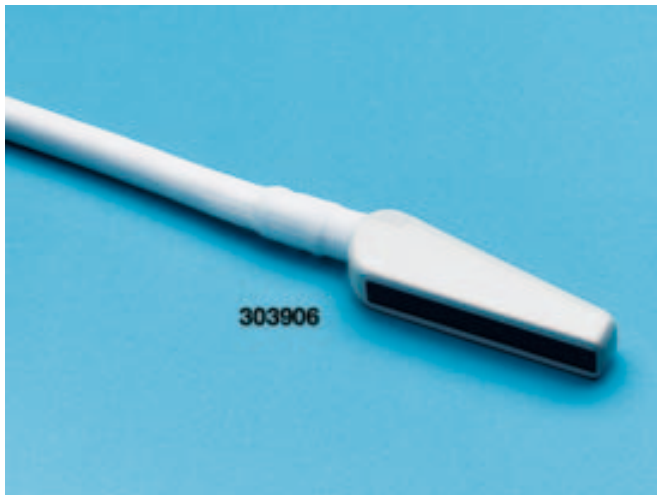

TRANSDUCER 5.0 MHZ LINEAR

For ALOKA SSD 500

- slim rectal probe
- for rectal examination of mares and large animals

303906



TRANSDUCER 5.0 MHZ CONVEX

For ALOKA SSD 500

- for complete abdominal sonography on small animals

303908

ASPIRATION SYSTEM

For bovine follicle puncture under ultrasound diagnostics

- easy to use
- for reproductive medicine
- attachable to probe 5.0 MHz No. 303908

303922

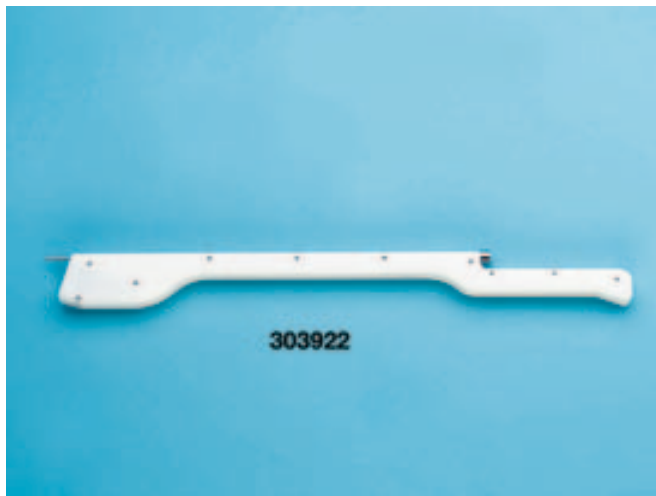

HAND SWITCH FOR ALOKA SSD 500

Easy freezing or printing of image

- to clip on jacket
- ideal for rectal exams
- just press desired button

303957

112.5



VET Eickemeyer®

Visit us on our website
www.eickemeyer.de

OFFSET FOR PROBES

To show tendons with 5.0Mhz linear probe

- excellent coupling
- robust aluminium case
- ergonomic design

For ALOKA and EICKEMEYER Magic probes

303927

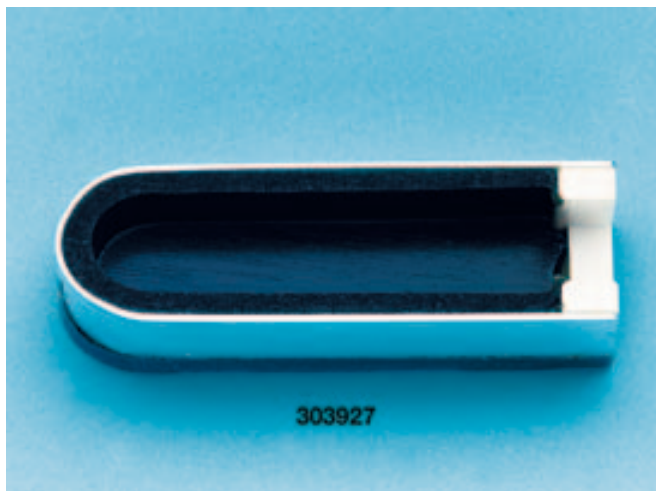

EICKEMEYER

Magic 9000

Brilliant color imaging capability and excellent 2D performance, with impressive THI (tissue harmonic imaging) for better contrast and spatial resolutions



Ultrasound Made Portable

Scan Method Electronic linear, convex, micro convex, phased array • **Gray Scales** 256 • **Display Modes** B, B+B, B+M, M, Color mode, Power mode, PW Mode, CW • **Broadband & Multifrequency probes** 5,0 / 6,5 / 8,0 MHz (mikro-konvex) 5,0 / 7,5 / 10 MHz (linear T-shaped) 2.0/2.5/3.0 MHz/H 3.5/H4.0MHz (phased array) • **TGC control** 8 Stufen • **Measurements** Distance, area, volume, circumference, angle, EDD, kardiologische Messung • **Screen** 15" Monitor • **Patient Information** Comprehensive Patient Data Management • **Cine Memory** 1024 Frames • **PC-Connectivity** USB-Port (2), VGA, Serial Port, Audio Port, Mic Port • **Power Supply** Netz-und Akkubetrieb möglich • **Video Output** Composite video / VGA / S-VIDEO / RGB • **Transducer Connectors** 3 • **Dimensions** H = 361 x B = 357 x T = 75 mm • **Gewicht** 6 kg

Scan Depth: up to 30cm deep.

Complete imaging modes:

2D, M, PW, HPRF, CW, Free Xros™ (anatomical M mode), Color, Power and DirPower.

iScape™ View (panoramic imaging) and trapezoidal imaging expands to a wider field of vision

iBeam™ function, which is a spatial compounding imaging technology, increases spatial resolution without any compromise in frame rate, thus collecting more useful information to generate higher quality images.

Quickly optimize the image quality with one button iTouch™ (intelligent image optimization) for better whole field grayscale and uniformity

- I- P (image processing) for balanced parameter groups
- Soft keys for direct menu function on the interface
- Small size – easy to transport
- Weight: 6kg



4806968

micro convex,
5.0 MHz/6.5 MHz/8.0 MHz

303710

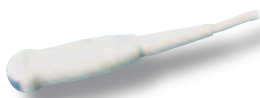

linear T-shaped,
5.0 MHz/7.5 MHz/10.0 MHz

303711



phased array
2.0/2.5/3.0 MHz/H 3.5/H4.0MHz

304454



VET Eickemeyer[®]

Medizintechnik für Tierärzte

State of the art continuing education centre in Tuttlingen, Germany



Since 1985 almost 10.000 veterinary professionals from all over the world have attended our courses.

Theory lectures, practical demonstrations and hands-on veterinary seminars in full operating theatre facilities provide the maximum learning in the minimum time.

PUNCTURE ADAPTERS

Puncture Adapter for ALOKA probes
No. 304130 and No. 304140
- for taking biopsies during ultrasound
examinations

303923

Puncture Adapter for EICKEMEYER MAGIC
Transducer

- for taking biopsies during ultrasound
examinations

303921

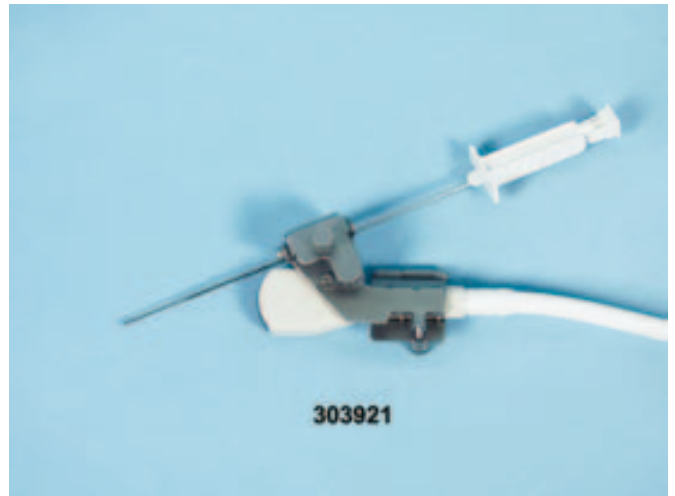

303921

ULTRASOUND GEL

0.25 litre bottle

303930

1 litre bottle

303931

Ultrasound Gel SONOGEL

- mucosa compatible
- can be used for ophthalmic exams
- 10 litre canister

303933

Filling set for 10 litre canister

303934



303930

303931

303933

303934

VIDEO PRINTER SONY UP 895

For Ultrasound Machines, 256 grey scales

- brilliant resolution images
- possibility of 3 different image sizes
- easy to operate

303959



303959

Paper for Video Printer, Cart for Ultrasound Machine



PAPER FOR VIDEO PRINTER

Best quality for diagnostic and documentation

For MITSUBISHI P 66 E, roll, single
303714

For SONY UP 860/890/895, 10 rolls/box
303952

For SONY UP 860/890, roll, single
303956

For Printer UP895, 5 rolls/box
303958

For SONY up 860/890, 5 rolls/box
303953



CART FOR ULTRASOUND MACHINE

- dimensions: 50x40x82cm, colour: white
- ultrasound machines storage cart
- easy to move
- easy to clean

303970

Cable arm

- practical storage for one transducer

303972

VET Eickemeyer®

Visit our Online-Shop
www.eickemeyer.de

ULTRASOUND TABLE

- Made of plastic: PE 500
- for cardiology ultrasound examinations
 - with ergonomic cut out
 - with 5 foldable feet
 - fits on all major treatment tables
 - dimensions: 140x60x18cm

303978

Cushioned overlay with cut out for
Ultrasound-Table 303978

- double sided
- with Velcro strips

not illustrated

303979

Reduction-Insert for cats

303977

ULTRASOUND POSITIONER

- for easy positioning of the patient during examination
- perfect positioning for better ultrasound pictures
- durable and easy to clean
- colour: red

Size 1, 80x25x10cm for cats

303991

Size 2, 100x35x14cm for medium dogs

303992

Size 3, 130x50x20cm for large dogs

303993

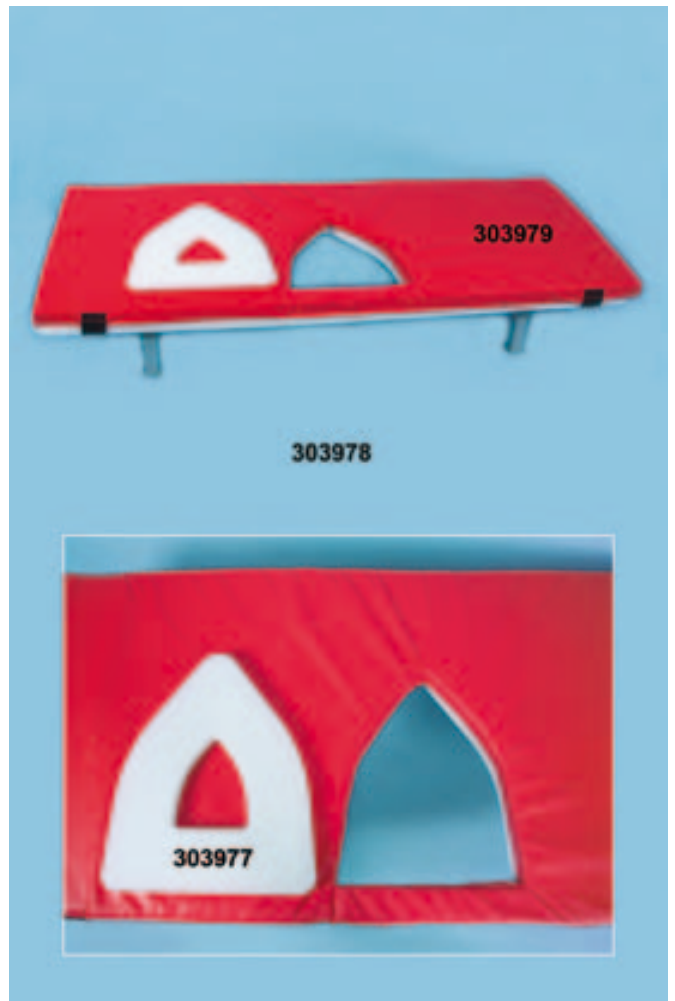

Stethoscopes



3M LITTMANN STETHOSCOPES

Known worldwide for superior acoustics

LITTMANN CLASSIC II S.E., 71cm

- dual head chestpiece with "Dual-Frequency" membrane
- single tube
- internal spring
- diaphragm diameter = 47mm
- bell diameter = 36mm

310035

LITTMANN CLASSIC II, 71cm for small animals

- dual head chestpiece with "Dual-Frequency" membrane
- single tube
- internal spring
- diaphragm diameter = 23mm
- bell diameter = 30mm

31004002

Ear-tips for stethoscope LITTMANN, pair

310037



EICKEMEYER STETHOSCOPES

Tube length = 40cm

- very good diagnostic quality
- chestpiece with 2 changeable diaphragms
- accessories included
- good price performance

310044

With long tubes, 60cm

310046



LITTMANN MASTER FOR CARDIOLOGY

- 69cm
- unique patented chestpiece with 'Dual*frequency' membrane (D = 50mm)
- suspended diaphragm
- two*tubes*in*one*design
- internal spring

31004003

3M LITTMANN STETHOSCOPE FOR CARDIOLOGY DIAGNOSTICS

LITTMANN Master for cardiology, 69cm
- unique patented chestpiece with Dual-frequency membrane (D = 50mm)
- suspended diaphragm
- two-tubes-in-one-design
- internal spring
31004003



CLINICAL THERMOMETER

Veterinary, extra solid tip, with strong plastic case
- with fixation knob
310130

Digital, water resistant, with beeper, switches off automatically
310140

Probe covers for digital thermometer, 1000/pkg.
- soft foil
- one size fits all
not illustrated
310145

Thermometer jar, stainless steel 30x90mm
- convenient storage and for disinfecting glass thermometres
310170



REFLEX HAMMERS

TRAUBE, 17cm, 100g, metal handle
310217

TRAUBE, 19cm, 190g, wooden handle
310219

TAYLOR, 20cm, rubber, wedge shaped
- ideal for neurological examination of small animals
310220



PLEXIMETERS

HANNOVER pattern, S-shaped, 16cm
310402

Spatula-shaped, for horses
310403



PC-Based Electrocardiogram



PC-BASED ELECTROCARDIOGRAM

Standard with serial port

- 6 lead ECG
- with long ECG recording time (up to 1 hour)
- automatic measurements and storage
- integrated database for patient data
- easy to connect and install
- ECG can be send as an E-Mail
- including 5-lead patient cable and alligator clamps
- easy USB connection

321018

3-lead patient cable with breathing sensor for Monitoring and ECG

321022

Software Installation for the PC-ECG

321025

ECG-Analysing-Service. Our experienced cardiologists analyse your ECG via E-Mail.

- saves time and money

S321020000

Long-term ECG software update (recording up to 1 hr)

321019

ECG RECORDER CARDIETTE

- with 5 lead patient cable
- 60mm paper width
- compact and lightweight (1000g)
- with filter for muscle/net interferences
- optional pc software available

321150



ECG ACCESSORIES

Alligator Clips for ECG recorders, 5/pkg.

321605

Alligator Clips for horses

321606

Needle electrode with Luer

321607

ECG extension cable for horses,
length = 1000mm, 5/box

not illustrated

321160

ECG gel, 250g

321625



ECG-PAPER

- thermoreactive

ECG Paper for CARDIOLINE 60mmx15 m

321151





SURGICAL CO₂ LASER

The ‚Workhorse‘ of Human Laser Surgery now available to the Veterinary Clinic. The laser is an intense beam of light that replaces a scalpel in a number of procedures. It is a multipurpose tool because it cuts, cauterises, vaporizes or sterilises the tissue. The way a laser beam reacts with tissue is what makes such an exceptional instrument. A laser seals nerve endings and blood vessels as it cuts. As a result, the patient feels less pain and there is nearly no bleeding. The energy of the CO₂ beam is emitted in the upper tissue which leads to less infraction of the lower tissue.

Evident Advantages:

- high precision
- reduced blood loss
- clear and dry operation field
- highly sterile surgery
- decreased pre and post-operative pain
- decreased swelling and inflammation
- reduced post-operative irritation
- quicker recovery
- increased survival rate
- powerful: 15 Watt
- small dimensions: L = 61 x W = 36 x H = 21cm
- weight = 12kg

325000

Smoke Evacuation Unit for Laser Surgery

325010

Replacement Filter for 325010

325015



RADIOSURGERY UNIT SURGITRON

- The SURGITRON features a continuously linear intensity setting for precise,
- predictable control to minimise tissue destruction and charring. This promotes faster healing with minimal scarring and serves to eliminate unfavourable post operative conditions such as trauma, pain, swelling and infection.
 - the unique feature is that the entire shaft of the electrodes can be bent or contoured for easy accessibility in all areas
 - the antenna plate does not require direct skin contact.
 - ideal in dermatology, gynaecology, facial (dental/eyes)

140W / 3.8MHz, complete set with Foot Switch, Hand Piece, Antenna Plate and one Set of Electrodes
323000

Electrodes, Depilatory Needles, Radiosurgery Accessories



ELECTRODES FOR BLACK HAND PIECE

- shaft diameter 1/16"
- bendable
- easy to clean

Set of Electrodes (1 each)
A8/F1/A3/C7/B1/D8/B3

323002

Round loop, small, (TB7), 2/pkg

322999

Triangular, straight, (C7), 2/pkg

323010

Rhombic form, small, (C3), 2/pkg

323037

Fine wire, round loop, small (B1)

323028

Fine wire, round loop, large (B3), 2/pkg

323029

Regular wire, large, (B6), 2/pkg

323011

Regular wire, small, (B4), 2/pkg

323012

Needle form, (A3), 2/pkg

323013

Ball, D = 2mm, (D3), 2/pkg

323014

Ball, D = 2.3mm, (D8), 2/pkg

323034

Ball, D = 4.3mm, (D5), 2/pkg

323040

VARI Tip, 1/16" shaft, angular, with adjustable and extendable wire, (A8), 2/pkg

323016



DEPILATORY NEEDLES

Very delicate, set of 3 pcs, (D7)

323017



OPTIONAL EQUIPMENT FOR SURGITRON

Electrode sterilisation protector stand

323036

Rack, Plexiglas for 18 electrodes

323018

Sand Paper to clean electrodes, 4/box

323019

Steri Caps, 6/box, autoclavable

- to change settings during surgery

323035

HANDPIECES FOR SURGITRON

Handpiece with Finger Switch, Adaptor and one set of Electrodes No. 323002

323020

Handpiece, black for both sizes of electrodes

323004

Handpiece, black for scalpel blades and 1/16" electrodes

323025

BIPOLAR ACCESSORIES

Bipolar Converter for simultaneous monopolar and bipolar operation

323095

Bipolar Cord, for Bipolar Forceps, autoclavable

323030

Bipolar Forceps, 15cm, straight, autoclavable

323006

Bipolar Forceps, 11.5cm, straight, autoclavable

323031

Radiosurgery Accessories, Bipolar Forceps

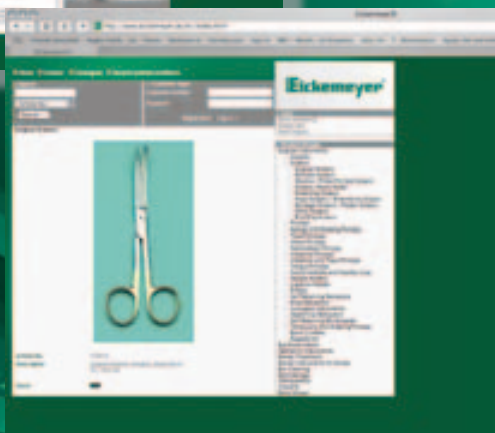
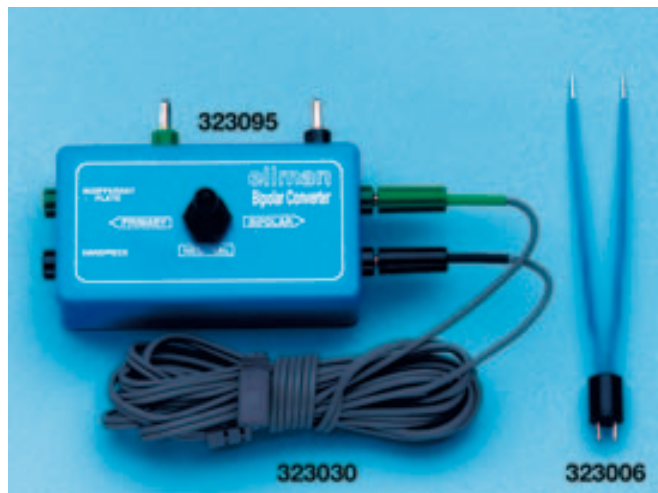

Eickemeyer Online
– www.eickemeyer.de

Our website is dedicated to giving your clinic the services it demands:

Product information, stock availability, special offers and online ordering are just some of them.

You can access our online ordering service 24/7
– to log in all you need is your customer number and your postcode.

Radiosurgery Unit



323100

RADIOSURGERY UNIT EICKEMEYER 120VET

- for simultaneous monopolar and bipolar operation
- radiosurgery techniques for all kind of patients
- for cutting, coagulation and microcoagulation
- precise operation with flexible electrodes
- lightweight, only 3.5kg
- small and compact dimensions: 260x250x80mm
- best price performance

120W / 460kHz, complete set with Foot Switch, Hand Piece, Antenna Plate and one Set of Electrodes
323100

Accessories for Radiosurgery, Radiology Scissors, Electric Cautery

ACCESSORIES FOR RADIOSURGERY UNIT EICKEMEYER

Bipolar Forceps, 15cm

323105

Bipolar Cord, for Bipolar Forceps, autoclavable

323106

Electrode-Handpiece with cord
not illustrated

323120

Handpiece for Depilatory Needles

323125

Depilatory Needle 0.1mm
(to use with 323125 handpiece)

323126

Electrode, small loop, black

323108

Electrode, large loop, brown

323107

Electrode, wide loop, green

323109

Electrode, needle type, blue

323110



MONOPOLAR SCISSORS

Monopolar Scissors METZENBAUM straight
18cm

326700

Monopolar Scissors METZENBAUM, curved,
18cm

not illustrated

326701

Cord for connecting Monopolar Scissors

not illustrated

326703

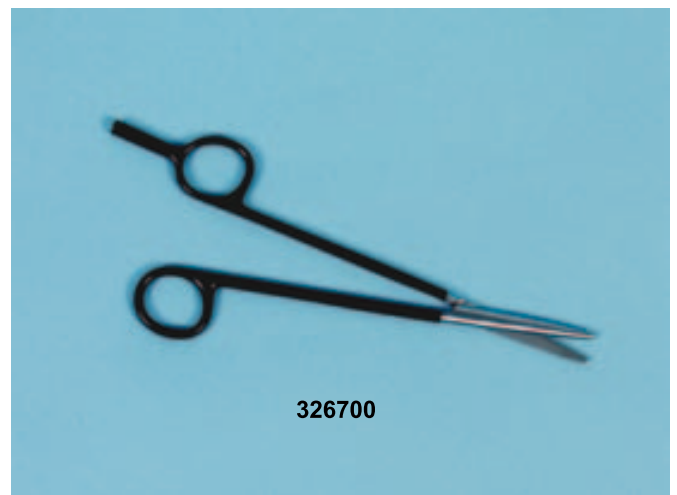

ELECTRIC CAUTERY UNIT

ENGEL CAUTER 100S

- small portable cautery unit

- with illuminator

- 80W

- lightweight: only 980g

- very durable

- best price performance

324000



Electric Cautery



ELECTRIC CAUTERY UNIT

- 100 N with ergonomic pistol grip
 - with illuminator
 - 100W
 - lightweight: only 600g
 - colour: blue
- 324050**

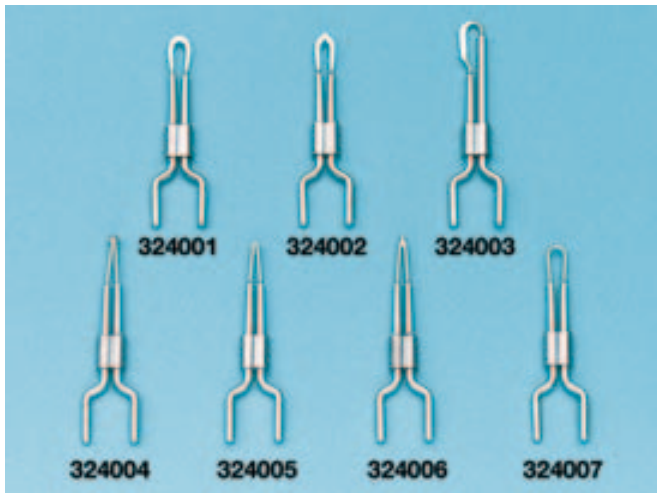

CAUTERY TIPS

- heat-resistant special steel
- non-oxidising
- easy to clean and to disinfect

Flat, round

324001

Flat, sharp

324002

Hatchet

324003

Pointed

324004

Loop, sharp

324005

Sharp

324006

Round

324007

Adapter for Cautery Tips, fits on ENGEL

CAUTER No. 324000

not illustrated

324012



BATTERY CAUTERY SET

- With charging station
 - small portable unit
 - high intensity illuminator
 - powerful 10 Watt
 - with 2 cautery tips (loops)
 - with one cautery tip (fine)
- 324040**

Vaginal Specula, Uterine Forceps, Infusion Kit for Horses

VAGINAL SPECULA KILLIAN

- 14cm, with long jaws
 - also conveniently doubles as a mouth gag for rodents
- 340014**



VAGINAL SPECULUM POLANSKI

- length = 25cm
- with wing screw

ECONOMY model

340025

Original HAUPTNER model

340026



UTERINE BIOPSY FORCEPS FOR HORSES

- length = 65cm
 - with fenestrated basket
 - razor sharp
- Fast and easy sampling

343165



INFUSION KIT FOR HORSES

Infusions Kit for horses

- ceiling mounted
- easy to adjust
- easy to handle

402130

Infusions Set IV 1000 for horses

- large volume tubes for easy handling
- not illustrated*

402132



Infusion Pump



INFUSOVET INFUSION PUMP

Small and programmable Infusion Pump

- easy handling
- flow speed 0.1–999ml/h
- battery operated up to 16 hours and mains operated
- large and easy-to-read display
- compact and portable
- lightweight: only 1100g
- accurate dosing
- reliable

402065

Infusion set for INFUSOVET with injection port, length = 2.1m, 100 pack

not illustrated

402067

SYRINGE INFUSION PUMP

- easy handling
- microprocessor-controlled precise dose
- large and easy readable display
- battery/mains operated
- uses standard disposable 10/20/30/50ml syringes

402080



402080

SYRINGE INFUSION PUMP EICKEMEYER

- easy handling
- microprocessor-controlled precise dose
- uses standard disposable 2–50ml syringes
- dosage 0.1–100ml/h or 100–1000ml/h
- lightweight

402085



402085

IV STAND

- 5 ball bearing swivel casters
- stainless steel
- adjustable from 120cm to 210cm
- with 4 prong hooks
- 5 swivelling castors
- 2 lockable castors

573105

With single handed height adjustment
not illustrated

573200



573105

FEEDING AND DOSING NEEDLES FOR BIRDS

Luer lock, stainless steel, 2/box

6.4×152mm, straight

405810

6.4×102mm, straight

405812

4.0×76mm, straight

405814

3.0×76mm, straight

405816

2.4×51mm, straight

405818

1.4×38mm, straight

405820

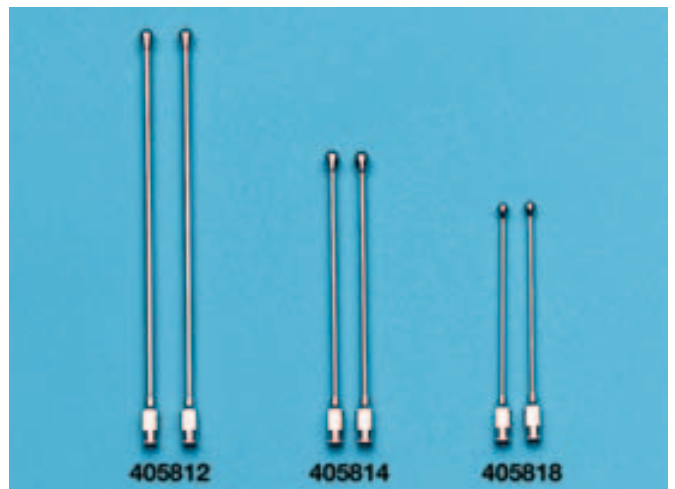

405812

405814

405818

Syringe Holder, Biopsy Needles

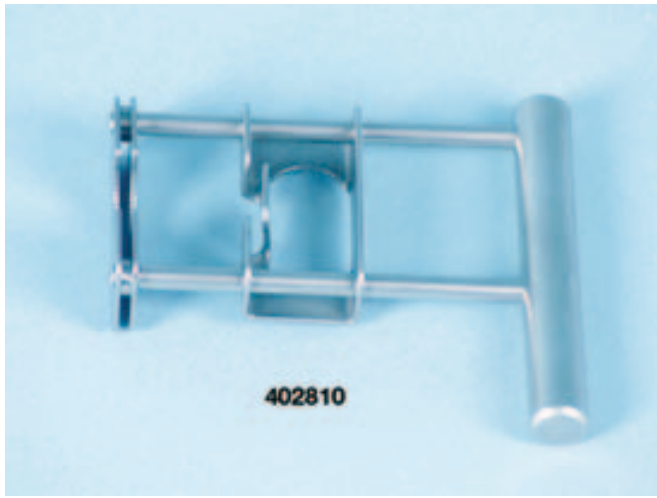

SYRINGE HOLDER FOR ASPIRATION BIOPSY

Single handled aspiration biopsy for cytology examinations

- safe aspiration of small areas
- one hand free to fix the tumour and for sonographic control
- small, compact and easy to handle
- for 10ml syringes
- autoclavable

402810

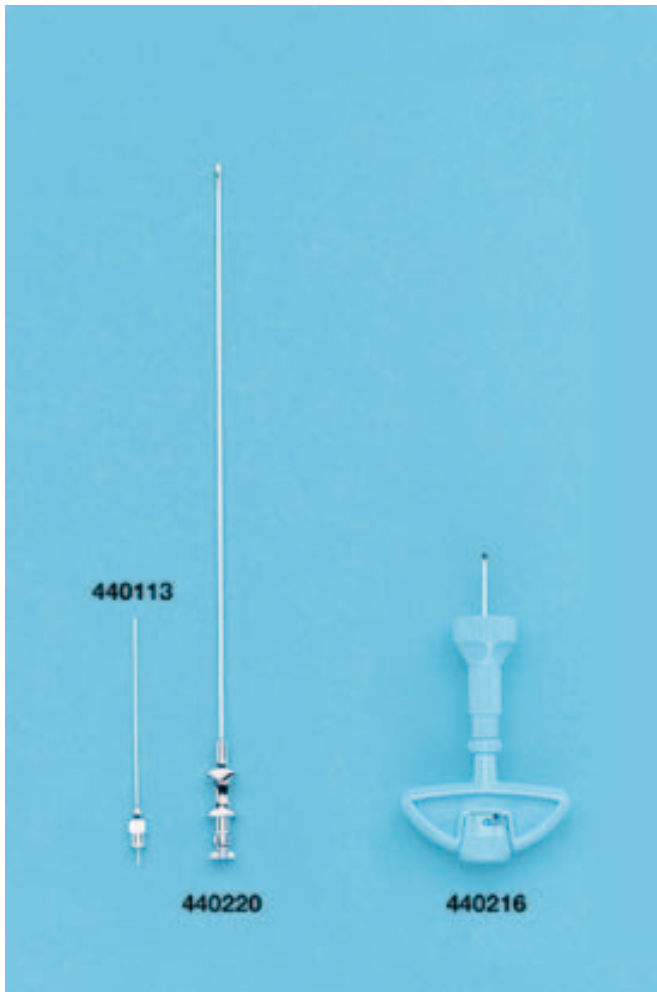

BIOPSY NEEDLES

MENGHINI, 1.2x100mm, Luer lock

440113

BIER, for lumbar puncture, 0.8x100mm, Luer lock

440208

BIER, for lumbar puncture, 1.1x70mm, Luer lock

440211

BIER, for lumbar puncture, 2.0x100mm, Luer lock

440220

ILLINOIS sternal biopsy / bone marrow needle, 1.6x50mm

440216



BIOPSY NEEDLE FOR HORSES

DÖNECKE, 3.0mmx30cm, Luer lock, with mandrin

440213

Biopsy Needles, Spinal Needles, Myelography Needles, Lacrimal Needles

BIOPSY NEEDLES

KLIMA ROSEGGER sternal biopsy needle,
1.8x35mm, for bone marrow biopsy

440218

Biopsy needle 1.6x150mm, 16G,
for liver and kidney biopsy during ultrasound

440316

Biopsy needle 2.1x150mm, 14G,
for liver and kidney biopsy during ultrasound

440321

BIO-CUT, soft tissue biopsy needle,
2.1mmx15.2cm, disposable

440315



SPINAL NEEDLES

- for myelography
- sterile
- 20/box

Black, 0.7x70mm

440407

Yellow, 0.9x70mm

440409

Yellow, 0.9x38mm

440414

Pink, 1.2x70mm

440412

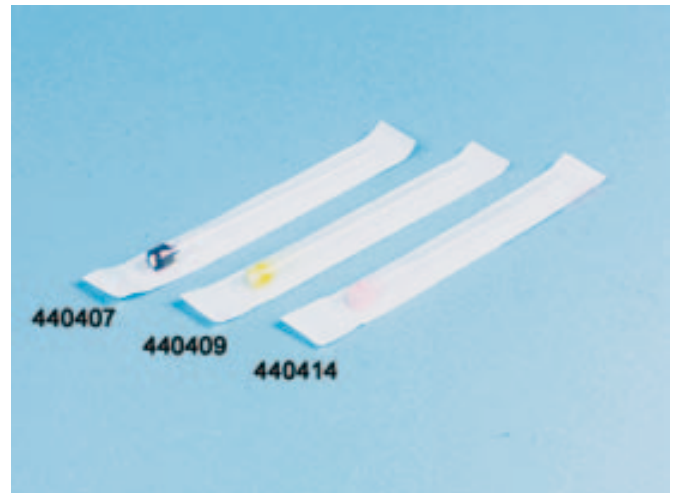

MYELOGRAPHY NEEDLES, STAINLESS

- with short bevel tip and mandarin
- Luer lock

0.7x50mm

440485

0.7x60mm

440486

0.8x80mm

440488

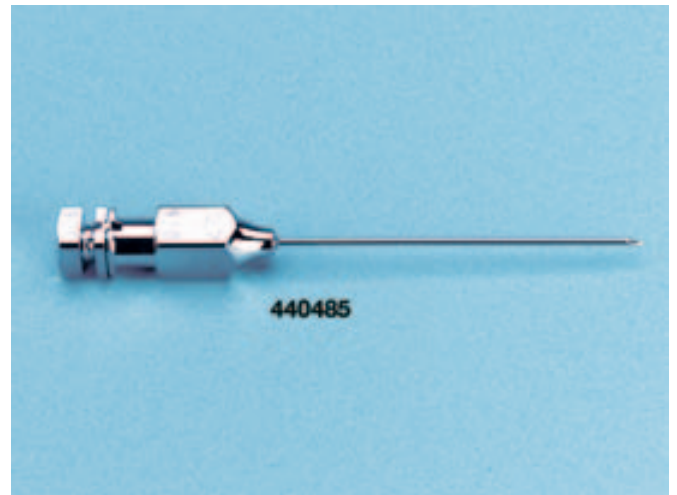

LACRIMAL NEEDLES

- to rinse the nasolacrimal duct
- with Luer lock

ANEL, straight, 0.6x15mm

440605

ANEL, curved, 0.6x15mm

440705

Olive tip, straight, 0.6x30mm

440805

Olive tip, curved, 0.6x33mm

440905

Curved, 25mm, beveled shaft

441007

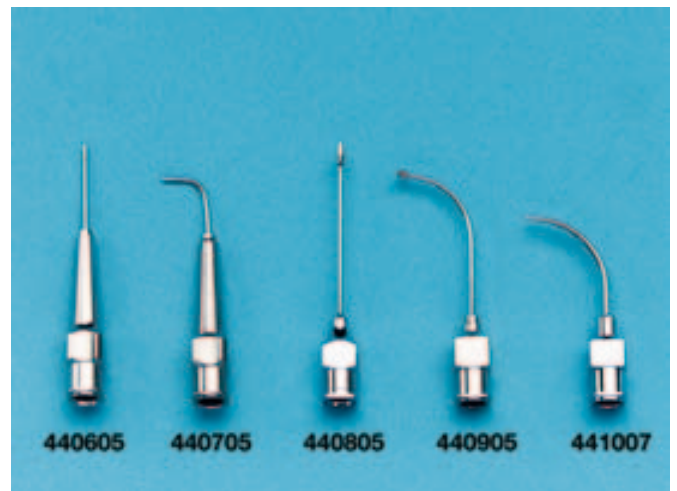

Irrigating Cannula, Anal Sac Cannulas, Tourniquets

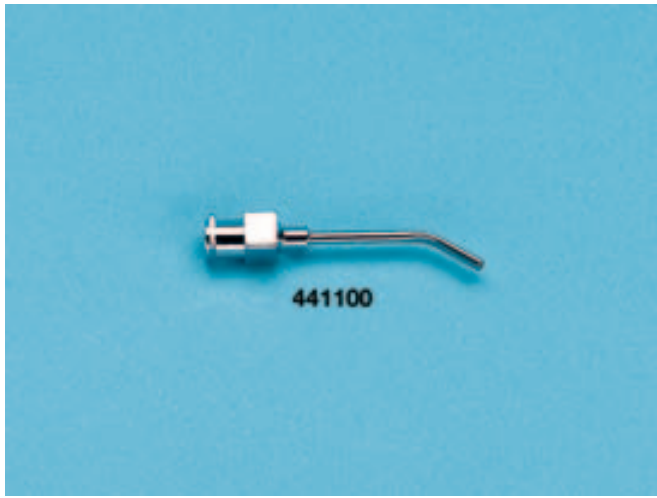

IRRIGATING CANNULA

- for lens extraction
- with Luer lock

BONN, strong model
441100

BONN, light model
441101

KNOLLE-PEARCE, irrigation loop
not illustrated
441120

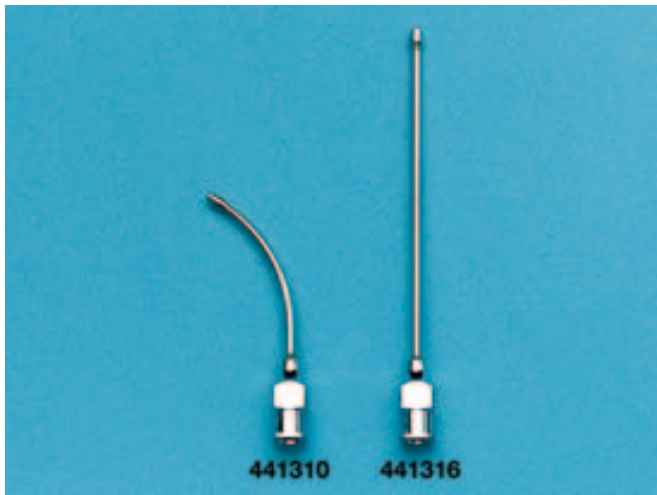

ANAL SAC CANNULAS

- stainless steel
- blunt probe tip
- with luer hub

0.8mm, curved
441308

1.0mm, curved
441310

1.2mm, curved
441312

1.5mm, curved
441315

1.5mm, straight
441316



TOURNIQUETS FOR SMALL ANIMALS

STRIPP-QUICK, quick release tourniquet
441900

Spare rubber band for STRIPP-QUICK
441901

Rubber tourniquet, D = 4.0mm, length = 1m
442002

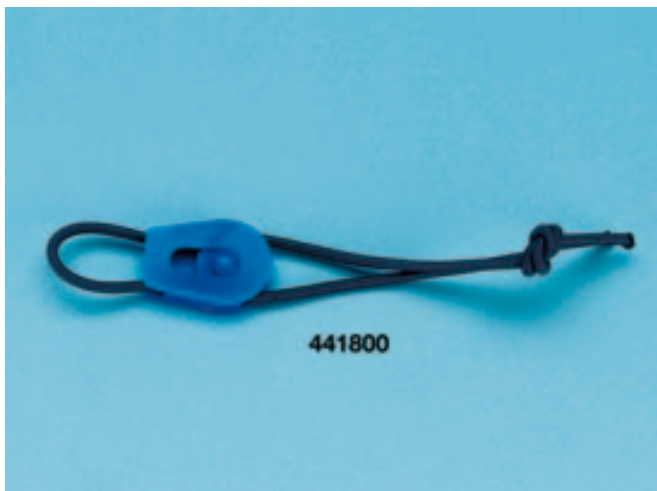

SMALL ANIMAL TOURNIQUET

- easy to tighten
 - tight fit
 - quick release with one hand
- 441800**

TOURNIQUET CLAMP FOR CATS

Japanese model

- easy to apply
- tight fit

441405



EQUINE TOURNIQUET ESMARCH

Small, 6x500cm

442006

Medium, 8x500cm

442008

Large, 10x500cm

442010

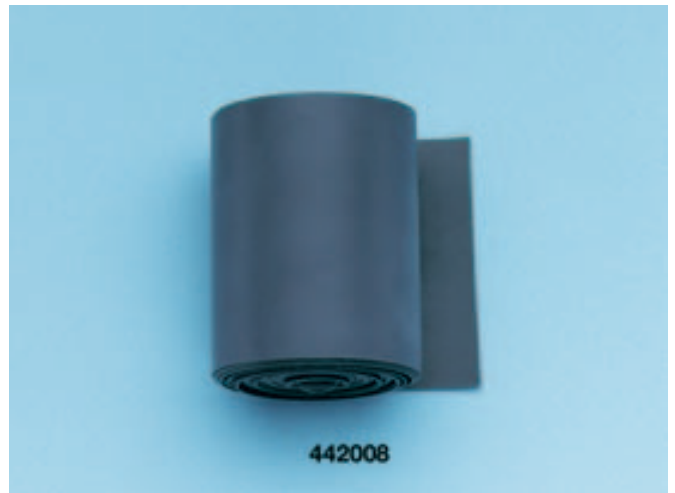

URINARY CATHETERS

- cylindrical, rounded tip
- with Luer lock
- 2 lateral eyes

EICKEMEYER, 1.0x110mm, pink, for tomcats,
with metal stylet

450010

EICKEMEYER, 1.3x110mm, white, for tomcats,
with metal stylet

450013

BUSTER, 1.0x130mm, with ligament plate w/o
metal stylet

450014

BUSTER, 1.3x130mm, with ligament plate w/o
metal stylet

450015



Cat Catheters, Catheters, Dog Catheters

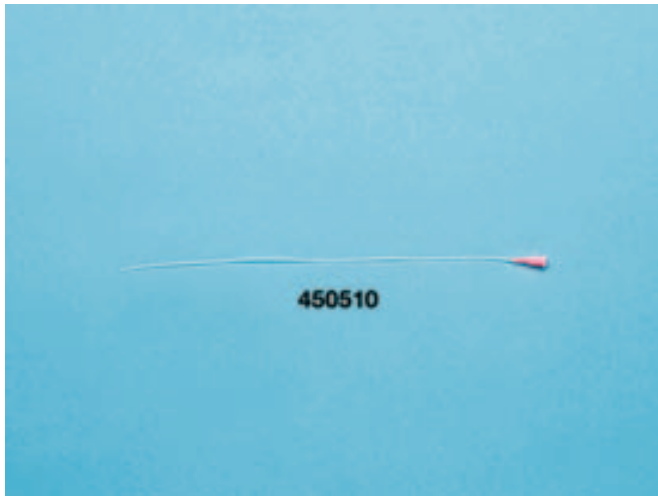

CAT CATHETERS

- with Luer lock

PORTEX, 1.0x305mm, pink

450510

PORTEX, 1.3x305mm, white

450513



DOG CATHETERS

- extra long and soft

- with Luer lock

2.1x500mm, yellow

451020

2.6x500mm, red

451026

3.3x600mm, white

451033

BUSTER, 2.0x500mm

451050

BUSTER, 2.6x500mm

451056

BUSTER, 3.3x500mm

451063

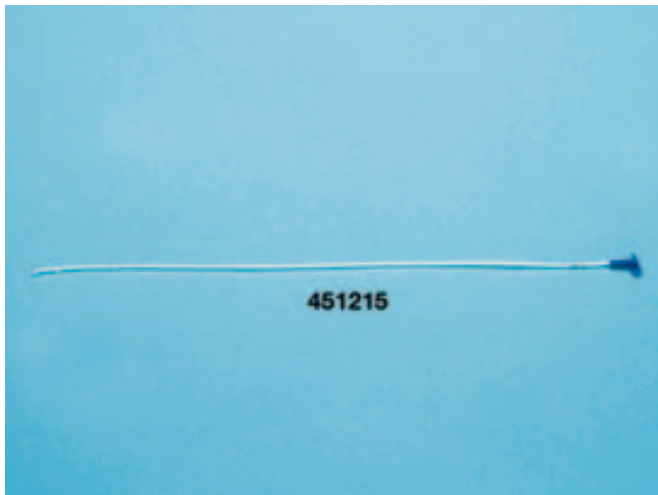

URINARY CATHETERS, PLASTIC

- cylindrical, rounded tip

- with cap

- 2 lateral eyes

- can also be used as a feeding tube

- with Luer hub

1.5x500mm

451215

2.1x500mm

451221

2.5x500mm

451225

3.0x500mm

451230



DOG CATHETERS, METAL

- stainless steel

- soft gliding closed tip

- 2 lateral eyes

- Luer hub

2.0x180mm

451520

2.5x250mm

451525

3.0x300mm

451530

Equine Catheters, Uterine Flushing Catheters, PEZZER Catheters, Uterine Culture Swabs

EQUINE CATHETERS

Mare Catheter, 8.0x700mm

- PVC
- sterile
- Luer hub

453380

Stallion Catheter, 6.5x1350mm

- transparent PVC
- sterile
- Luer hub

453065

UTERINE FLUSHING CATHETERS

Model BRESLAU, veterinary hub, ID = 8.0mm, length = 400mm

- can also be used as urinary catheter for pigs

454480

D = 5.0mm, length = 800mm, for horses

- silicone
- very flexible
- with cuff and balloon
- lateral eyes on open ended tip

454880

D = 8.0mm, length = 650mm, for horses

454665

D = 8.0mm, length = 800mm, for horses

454680

D = 8.0mm, length = 1500mm, for horses

454750

PEZZER CATHETER

- with 'mushroom' tip
- red rubber
- feeding tube for cats and dogs
- applied with the ELD instrument for percutaneous gastrostomy insertion

CH 10, D = 3.3mm

455210

CH 14, D = 4.7mm

455214

CH 18, D = 6.0mm

455218

CH 20, D = 6.7mm

455220

CH 22, D = 7.3mm

455222

DISPOSABLE UTERINE CULTURE SWAB

Length = 75cm

- unique system for collecting cultures
- ready to be shipped
- individually wrapped and sterile packaged

455375

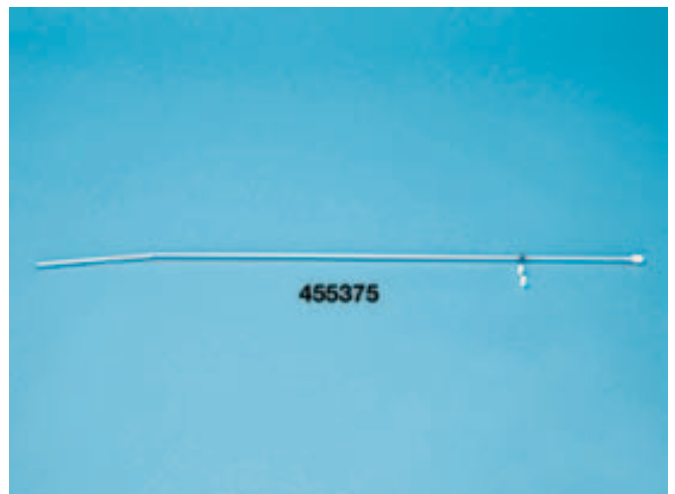
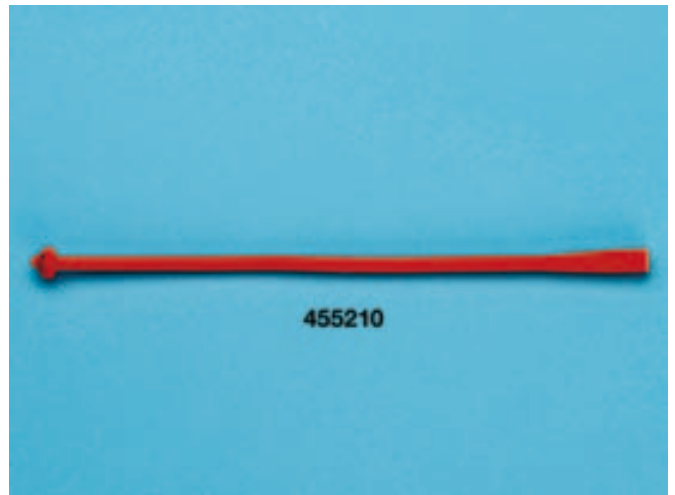
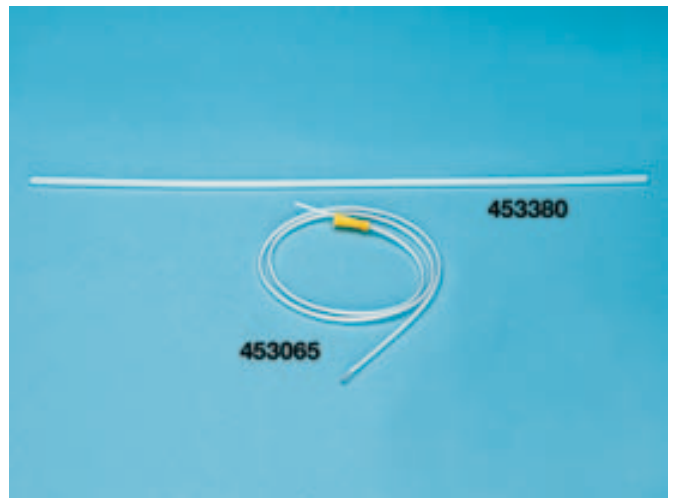

Uterine Culture Swabs, Disposable Culture Swabs, Drainage System, REDON-DRAINS

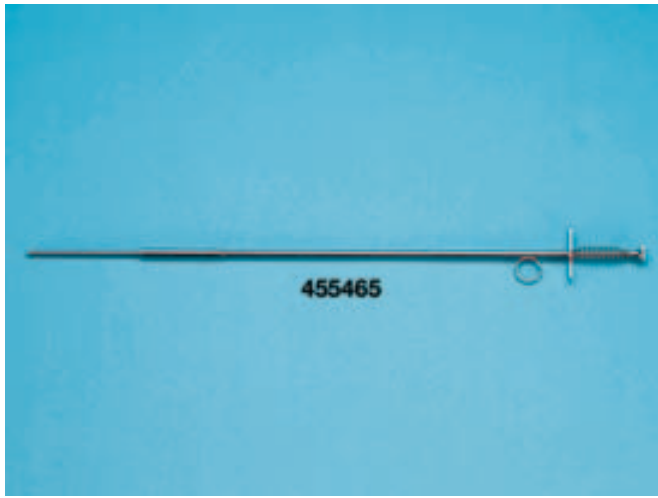

CULTURE SWAB HOLDING INSTRUMENT MERKT

For mares, 65cm, metal
455465

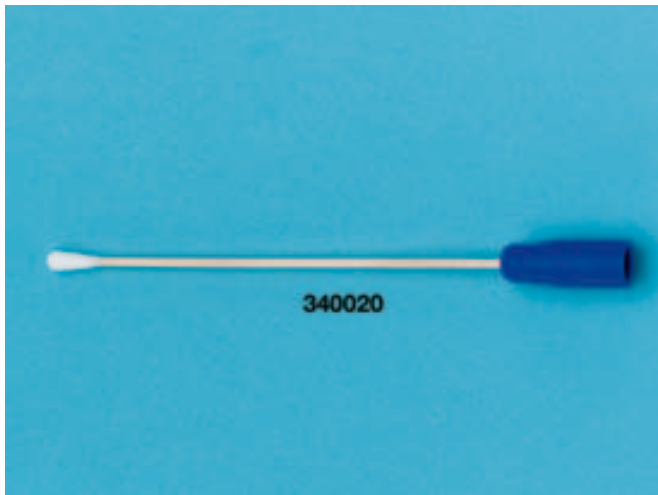

DISPOSABLE CULTURE SWABS, STERILE

TRANS-WISP, 25/box
340020

TRANS-WAB with AMES transportation box,
25/box
340021



DRAINAGE SYSTEM MINI-REDOVAC

Consists of 20ml suction bellow, delicate tubing
and needle
CH 6, D = 2mm
456006



REDON-DRAINS

- wound drainage
- individual sterile packed
- smooth lateral eyes and open end
- length = 520mm

D = 2.0mm, CH 6
456106

D = 2.7mm, CH 8
456108

D = 4.0mm, CH 12
456112

PENROSE-DRAIN

- pure yellow latex
- wall thickness: appx. 0.13mm

D = 6.3mm, width = 10mm, length = 100cm

457006

D = 8mm, width = 13mm, length = 100cm

457008

D = 10mm, width = 16mm, length = 100cm

457010

D = 13mm, width = 20mm, length 100cm

457013

D = 16mm, width = 25mm, length = 100cm

457016

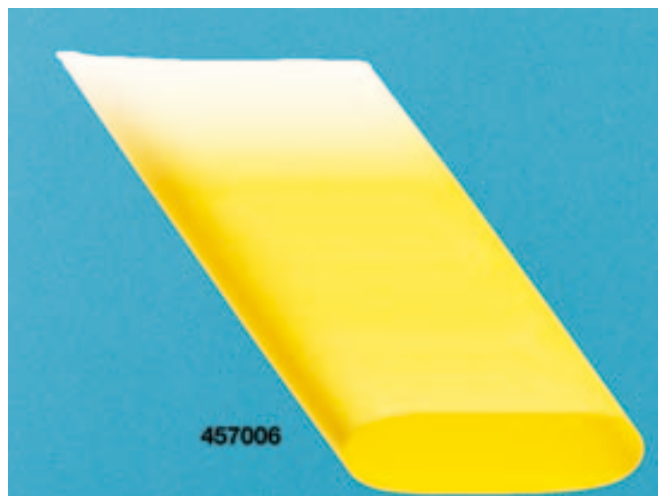

THORACIC DRAINS

- ideal for small animals
- individual sterile packed

Mini-bellow with connection for LEO-Valve

457570

Disposable LEO-Valve for thoracic drainage of cats and dogs

- for drainage of pleural cavity

457580

Thoracic Trocar Catheter for cats and small dogs, D = 3.3, length = 150mm

- easy to adapt to the LEO-Valve
- good skin incision is necessary for accurate placement

457585

Thoracic Trocar Catheter for large dogs,

D = 3.3, length = 250mm

- easy to adapt to the LEO-Valve
- good skin incision is necessary for accurate placement

457586



VET Eickemeyer®

Continuing Veterinary Education

Please ask for more details

HEIMLICH CHEST DRAINAGE VALVE

Disposable, sterile valve for drainage of the pleural cavity

- for dogs weighing more than 15kg
- postoperative suction drainage
- works in any position
- no need to disconnect

457550

3-way stop cock, plastic, luer hub, for 2 infusions / transfusions etc, individual sterile packed

457560

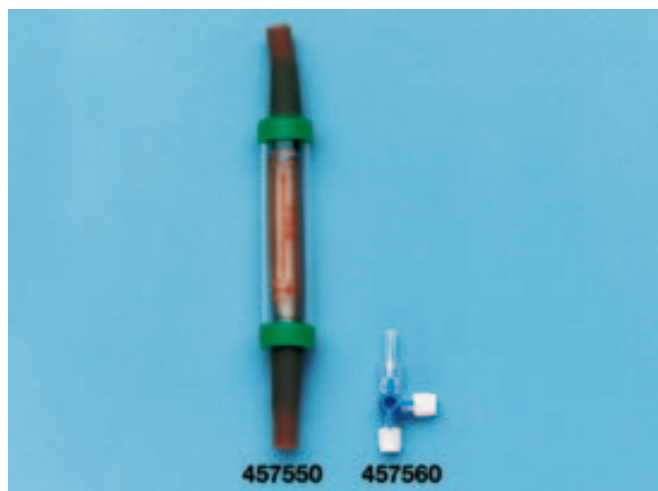

FOLEY Catheters, Stomach Tubes

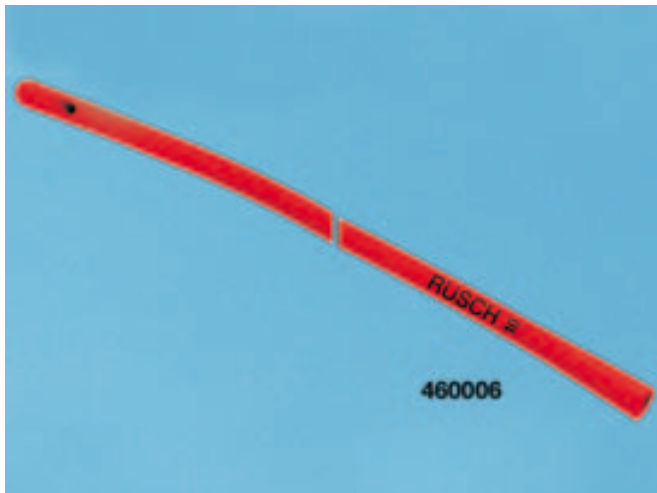

FOLEY CATHETER

- with Luer hub for balloon inflation
- cylindrical, non-traumatic tip
- two eyes

D = 2.7mm, length = 300mm, CH 8
457508

D = 3.3mm, length = 300mm, CH 10
457510

D = 4.7mm, length = 400mm, CH 14
457514

D = 5.3mm, length = 400mm, CH 16
457516

D = 6.7mm, length = 400mm, CH 20
457520

D = 10.0mm, length = 400mm, CH 30
457530

STOMACH TUBES FOR DOGS

These enteral feeding tubes have been designed for mid-long term enteral feeding

- durable, long lasting
- closed tip
- 2 lateral eyes
- can also be used as urinary catheter for cattle

D = 6mm, length = 750mm, soft rubber
460006

D = 8mm, length = 750mm, soft rubber
460008

D = 12mm, length = 1500mm, soft rubber
460012

D = 8mm, length = 800mm, plastic
460109

D = 11mm, length = 800mm, plastic
460111

RED RUBBER STOMACH TUBES NEUMANN-KLEINPAUL

- for calves and foals
- open tip
- soft rubber
- 1 lateral eye

D = 15mm, length = 250cm
460515

D = 16mm, length = 300cm
460516

D = 19mm, length = 350cm
460519

EQUINE STOMACH TUBE PORTEX

- flexible silicon tubing
- heat and cold resistant
- transparent
- funnel shaped end piece for quick attachment to a drench pump
- atraumatic rounded tip

D = 9.5mm, length = 210cm, for foals
460609

D = 13mm, length = 270cm, for horses
460613

D = 16mm, length = 270cm, for horses
460616

D = 19mm, length = 300cm, for large horses
460619

Equine Stomach Tubes, Oesophagus Flushing Catheter

EQUINE STOMACH TUBE ECONOMY

For foals

46060001

Small, ID = 9mm, OD = 13mm, for small horses

46060002

Medium, ID = 9mm, OD = 16mm, for horses

46060003

Large, ID = 11mm, OD = 19mm, for large horses

46060004



OESOPHAGUS FLUSHING CATHETER PICK

For pressure flushing of the congested oesophagus of horses

- D = 19mm, length = 200cm

- with standard connection water hose

460819



VET Eickemeyer®
Medizintechnik für Tierärzte



Autoclaves



MELATRONIC 23

- fully automatic sterilising cycle
- all characteristics for a safe sterilisation like ventilation or increase of pressure is done automatically
- more safety: The electronics check automatically if all necessary parameters for a successful sterilisation have been fulfilled
- error-recognition system displays reports of any deviations from complete successful sterilisation process
- long service life through high equipment quality
- insert rack
- includes 1 tray
- internal dimensions: D = 230mm, depth 420mm
- volume: 19 litres
- holds 5 trays (42x19x2cm)
- external dimensions: W = 51cm, H = 38, D = 55cm
- weight: 30kg

50002301

MELATRONIC 23 EN

With fractionated gravity system

- sterilisation programs "Class N" and "Class S"
- high grade electronic microprocessor control
- pressure and temperature sensors for recording and monitoring
- display to show all important informations
- built-in water storage tank
- water quality and dosing is verified fully automatically
- documentation with printer, flashcard or software
- external dimensions: W = 44cm, H = 33cm, D = 50cm
- internal dimensions: D = 23, depth = 45cm
- chamber volume: 19 litres
- incl. 1 tray: W = 19cm, D = 42cm, H = 2cm
- weight = 30kg
- 230 Volt / 50 Hz / 1.600 Watt

50002302

MELAG EUROKLAV 23VS+

- complies european norm "Class S" EN 13060
- microprocessor controlled fully automatic processing
- effective drying
- chamber depth = 45 cm
- PC connectable
- inkl. 1 tray (42 x 19 x 2 cm)
- chamber dimensions: D = 230 mm, depth = 450 mm, Volume = 23 litres
- Outside dimensions:
W = 42.5 x H = 48.5 x D = 66cm
- up to 4kg instruments, 700g textiles
- weight = 35kg

500032



MELAG VACUKLAV 23B+/24B+

- VAKUKLAV 24 B+ for Tap water connection
- works according to the fractionated pre-vacuum method
 - easy, fully automatic operation
 - 4 programs (universal, gentle, quick, prion); 2 test programs (Bowie & Dick, vakuum)
 - the deep post-vacuum ensures optimal drying of wrapped materials and large quantities of textiles
 - automatic water evaluation system
 - inkl. 1 tray (42 x 19 x 2 cm)
 - quick program (only 11 min)
 - Chamber dimensions: D = 230 mm, depth = 450 mm; Volume = 23 litres
 - Outside dimensions:
W = 42.5 x H = 48.5 x D = 66 cm
 - up to 7kg instruments, 2.5kg textiles
 - weight 48Kg

500060

VAKUCULAV 23B+ "stand alone", no tap water connection

500065



Vakuum Autoclave, Trays for Autoclaves, Water-Treatment Systems



500050

VACUCLAV 44B

Class B autoclaves work according to the fractionated pre-vacuum method. For maximum safety and speed.

- simple, fully automatic operation
- 5 programs (universal, gentle, quick, prion); 2 test programs (Bowie & Dick, vakuum)
- the deep post-vacuum ensures optimal drying of wrapped materials and large quantities of textiles
- automatic water evaluation system
- Speed program (11 min only)
- Chamber dimensions: D = 250 mm, Depth = 450 mm; Volume = 22 Litre
- Outer dimensions:
W = 46 x H = 50 x D = 68 cm
- up to 7kg instruments, 2.5kg textiles

With tap water connection

500050

Stand alone, no tap water connection

500055

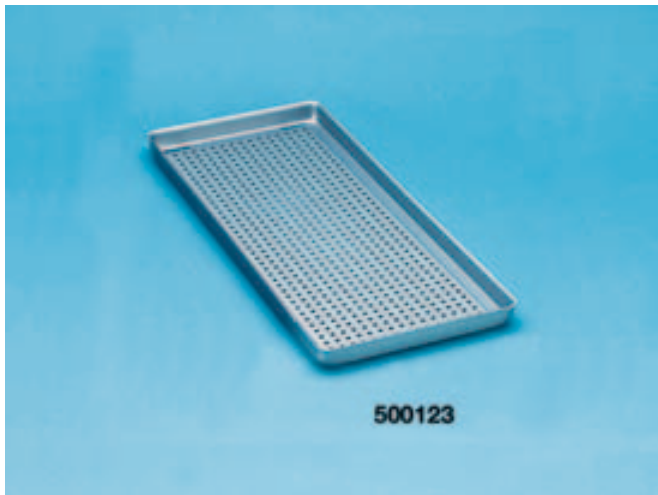

500123

AUTOCLAVE TRAYS

For MELAG, Type 23 and 24 (Type 23 takes 5 trays, Type 24 takes 6 trays)

500123

Tray handle for autoclaves MELAG

E50002402



506510

MELADEM 40 WATER-TREATMENT SYSTEM

To connect to EUROKLAV 23-S and VAKUKLAV 24-B

- the cost-effective ion exchanger
- the MELAdem40 can be directly connected to the MELAG autoclaves
- permissible water pressure 10 bar
- considerable saving of time and money
- the MELAG autoclaves VACUKLAV and EUROKLAV use built-in conductivity meters to automatically check the quality of the water produced
- protect and extend the service life of your autoclave
- optional MELAJet Spray Pistol to clean your instruments

506510

MELADEM 47 WATER-TREATMENT SYSTEM

To connect to your autoclave

- extraordinarily, environmentally-friendly cleaning which follows the reversal of the physical principle of osmosis
- the produced demineralised water assures uniformly high levels of water quality
- considerable saving of time and money
- automatic control of water quality
- enduring fresh water guarantees the longevity of instruments

506530

WATER DISTILLATOR

- easy water container transport
- inexpensive production of Aqua Dest
- highest quality water
- long life warranty for your instruments

506500



Autoclaves, Containers for Sterilisation



MELAG CLINIKLAV 25

The big one from MELAG!

- internal dimensions:
W = 32cm, H = 65cm, D = 65cm
- chamber volume: 67 litres
- safety door contact switch
- redundant process monitoring which is independent of the control system
- PT 1000 temperature sensor for exact closed-loop control, loop control and monitoring
- cost-effective water-ring vacuum pump
- high-quality vacuum pumps, innovative steam generator and top-quality stainless steel
- integrated printer for documentation
- outer dimensions:
W = 62cm, H = 80cm, D = 84cm
- lower cabinet option available

500026

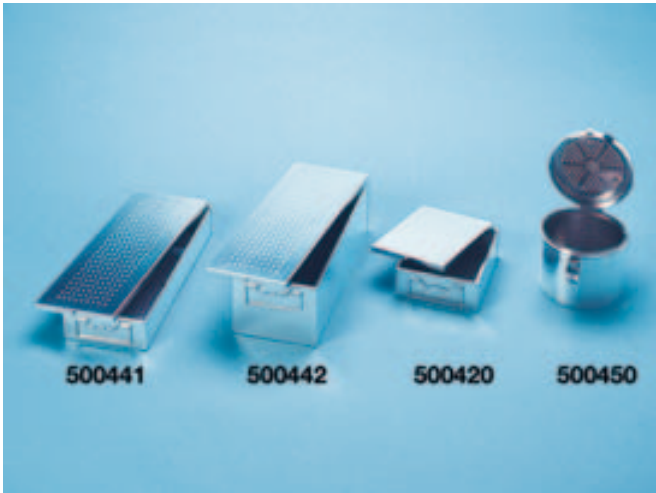

STERILISING CONTAINER FOR MELAG AUTOCLAVES

- for a secure storage of instruments during and after sterilisation
- stainless steel
- sizes designed to fit into MELAG autoclaves
- replaceable anti-germs cloth filter

For MELAG 17, L = 19cm, W = 14cm, H = 4cm
500319

For MELAG 17, L = 40cm, W = 14cm, H = 4cm
500340

For MELAG 17, L = 40cm, W = 14cm, H = 9cm
500341

For MELAG 17, H = 9.5cm, D = 13.8cm, round
500350

MELAG 23, 23S and 24, L = 20cm, W = 16cm, H = 6cm
500420

MELAG 23, 23S and 24, L = 41cm, W = 16cm, H = 6cm
500441

MELAG 23, 23S and 24, L = 41cm, W = 16cm, H = 12cm
500442

MELAG 23, 23S and 24, H = 14cm, D = 16.5cm, round
500450

STERILISING CONTAINER

Small set container, with perforated bottom,
L = 295mm, W = 138mm, H = 66mm

500800

Micro instrument tray with silicone pegged mat,
L 23xW 13xH 2.5cm

500823

Container with filter bottom, perforated,
L = 245mm, W = 135mm, H = 35mm
(use only with vacuum-autoclaves)

500535

Container with filter bottom, perforated,
L = 245mm, W = 135mm, H = 50mm
(use only with vacuum-autoclaves)

500550

Container with filter bottom, perforated,
L = 245mm, W = 135mm, H = 60mm
(use only with vacuum-autoclaves)

500560

Silicon pegged mat, 54x24cm,
for safe storage of your delicate instruments
- cut to fit

500810

Cloth filter, 100x120cm
- cut to fit

500500



500800

INSTRUMENT BOXES SMALL

With perforated top and bottom,
292x137x60mm

- to autoclave and store instruments
- with filter cloth
- different coloured covers available
- L = 292mm x W = 137mm x H = 60mm

With red top

185100

With green top

185101

With blue top

185103

Drapery, 400x600mm

185180



185100

POLCLAVE CONTAINER

- transparent plastic
- autoclavable up to 134°C
- lightweight
- dimensions:
L = 180mm, W = 80mm, H = 30mm

Beige

500860

Green

500861

Blue

500862



500860

Sterilisation Containers, Heat Sealing Unit, Sterilization Pouches

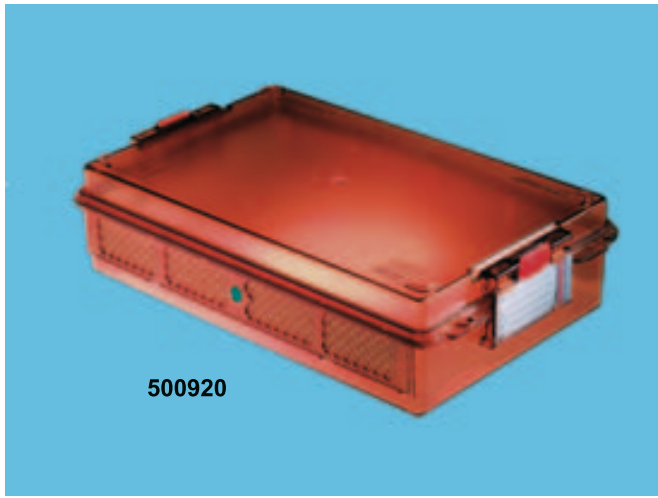

500920

TRANSPARENT PLASTIC STERILISING CONTAINER

- lightweight
- easy to close
- autoclavable up to 134°C
- filter material: PTFE-filter, reusable (approx. 250 times)
- sideways closure

L = 207mm, W = 105mm, H = 36mm

500920

L = 184mm, W = 144mm, H = 59mm

500924

L = 290mm, W = 183mm, H = 74mm

500929

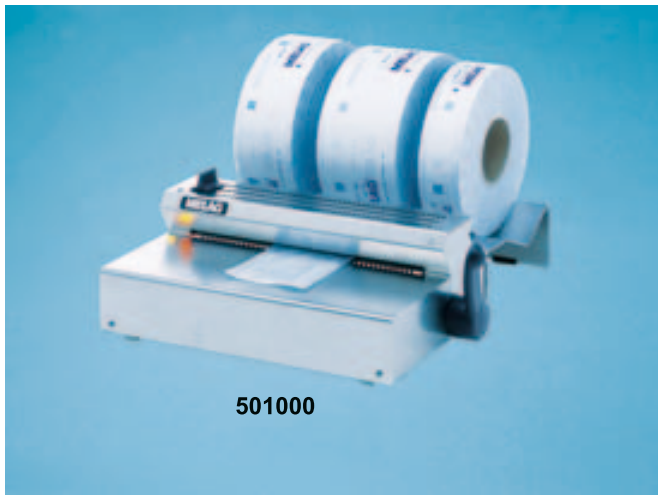

501000

HEAT SEALING UNIT MELASEAL 100

- wide sealing seam (10mm) for increased safety
- no warming up time because of impulse technique
- seals can be done w/o waiting time
- easy handling, no manual pressure required
- with cutter

Sealing device with carrier for sterilisation packing rolls

501000

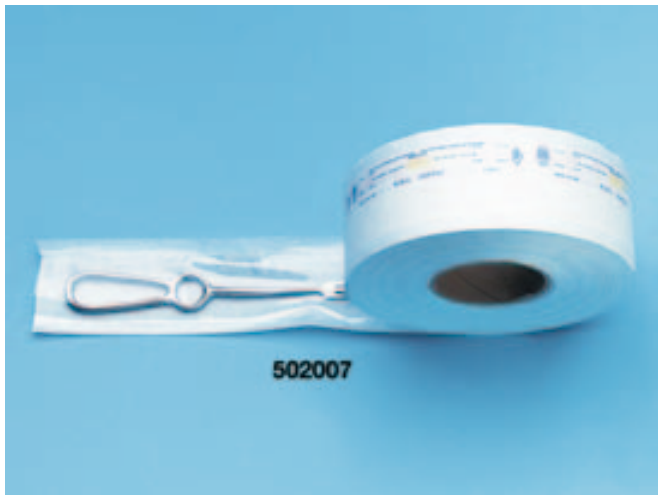

502007

STERILISATION POUCH TUBING

- tearproof
- resistant against germs
- one transparent side
- with indicator
- length: 200m

Width = 5cm

502005

Width = 7.5cm

502007

Width = 10cm

502010

Width = 15cm

502015

Width = 20cm

502020

Width: 25cm

502025

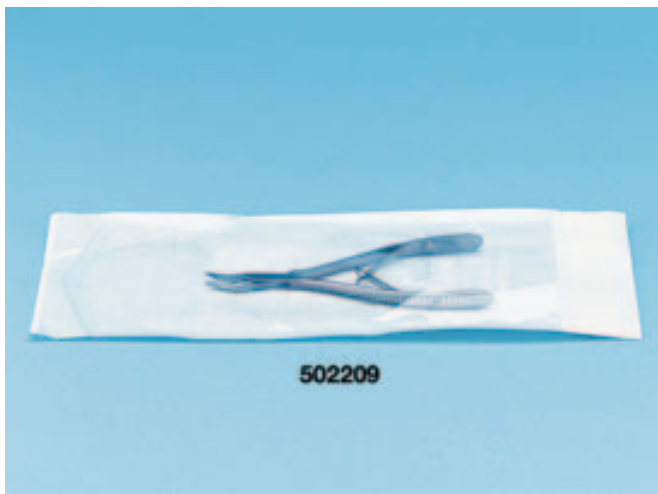

502209

SELF SEALING STERILISATION POUCHES

- self-adhesive tape
- see-through
- with indicator
- 200/box

Width = 90mm x length = 230mm

502209

Width = 133mm x length = 254mm

502213

INDICATOR TAPE FOR STEAM STERILISATION

Width = 19mm, length = 55m
502500



INSTRUMENT MARKING TAPE

- for colour coding of all types of instruments
- easy to wrap around
- width = 6mm, length = 6.2m

Red
502601
Yellow
502602
Blue
502604
White
502605

Set with 8 tapes (yellow, red, black, white, green, brown, blue, orange), width = 6mm, length = 2.5m
not illustrated
502600



DRY HEAT STERILISER WTB BINDER

- large stainless steel interior (28l)
- precise temperature adjustment
- for 2 trays
- outer dim.: W = 580, H = 400, D = 425mm
- inner dim.: W = 400, H = 280, D = 250mm
- including 2 trays
- timer 0-2 hours
- best price performance

Dry heat steriliser Typ E 28
515028

Typ E 28 with temperature limitation
515030

Tray for steriliser E 28, chrome plated
515128



Dry Heat Steriliser, Sterilising Film, Indicator Tape



DRY HEAT STERILISER WTB BINDER ED 53

- stainless steel interior
- microprocessor control system with LED-display
- excellent drying because of the optimal air guidance w/o ventilation
- fast and precise warming up to 300 degrees Celsius
- included timer 0–99h
- volume 53 l
- internal dimensions: W = 400, H = 400, D = 330mm
- external dimensions: W = 634, H = 617, D = 575mm
- including 2 chrome-plated trays

520000

Chrome-plated tray for steriliser Type ED53
520005



STERILISING FILM FOR DRY HEAT STERILISERS

Roll, length = 100 meter

Width = 50mm

515160

Width = 75mm

515161

Width = 100mm

515162

Width = 150mm

515163

Width = 200mm

515164

Width = 250mm

515165



DRY HEAT INDICATOR TAPE

Width = 19mm, length = 55m

515150

Instrument Containers, Gas Steriliser, Gas Ampoules, Exposure Indicator Tape Strips

INSTRUMENT CONTAINERS

- ideal for safe storage of your instruments during sterilisation
- stainless steel
- with lid

Small, 200mm×100mm×50mm

517021

Medium, 220mm×150mm×50mm

517022

Large, 305mm×205mm×50mm

517031



GAS-STERILISATOR ANPROLENE AN74I

- for save and gentle gas sterilisation
- automatic sterilisation process
- with 100% ethylenoxyd
- easy to install and operate

530181



ACCESSORIES FOR ANPROLENE GAS-STERILISATION

ANPROLENE refill kit, 60 pcs. (5cc)

530160

ANPROLENE refill kit, 20 pcs. (20cc)

530185

Chemical indicator AN 87

- Dosimeters change colour in proportion to the dose of sterilant they contact.
- Dosimeter integrators present visual assurance that all these parameters have been fulfilled.
- Pack with 25 pcs.

530170

Hazardous goods surcharge

S10000016



EXPOSURE INDICATOR TAPE STRIPS

Exposure indicator strips

530175



STERISOL UV Light, Ultrasonic Cleaner



STERISOL UV LIGHT

- For 20m² rooms
 - reliable bactericidal for your surgery
 - moisture resistant e.g. for large animal surgery rooms
- 502014**



BANDELIN SONOREX ULTRASONIC CLEANER

- removes blood and debris from instruments smoothly w/o hand scrubbing
- stainless steel tank
- quiet operation with 0–30 minute on/off timer
- heating unit (30–80° C)

Ultrasonic cleaner RK 100 H, with heating, internal dimensions:

L = 240 x W = 140 x H = 100mm

560010

Ultrasonic cleaner RK 100 w/o heating, internal dimensions: L = 240 x W = 140 x H = 150mm

561000

Ultrasonic cleaner RK 255 H, with heating, internal dimensions:

L = 300 x W = 150 x H = 150mm

560025

Ultrasonic cleaner RK 156 BH, with heating, internal dimensions:

L = 500 x W = 140 x H = 150mm

560015

Ultrasonic cleaner RK 156, w/o heating, internal dimensions: L = 500 x W = 140 x H = 100mm

562000

Cover for RK 100 / RK 100 H

561001

Cover for RK 255 H

561003

Cover for RK 156 / RK 156 BH

562001

Tray for RK 100 / RK 100 H

561002

Tray for RK 255 H

561004

Tray for RK 156 / RK 156 BH

562002

ULTRASONIC CLEANER

High performance cleaner incl. tray, cover and 2 litre STAMMOPUR DR 8 cleaning agent

- easy to read, bright LED Display
- easy 4-step operation "plug and clean"
- "SweepTec" for constant, solid and gentle cleaning
- internal dimensions: 300x150x150mm

563000



563000

INSTRUMENT CLEANING AGENT PREP LUBE

For the best possible care of your instruments.

- prolongs the life of your instruments
- 5l

564505



564505

AESCLAP STERILIT OIL SPRAY

For maintenance of instruments prior to sterilisation, an absolute necessity for lubricating and protecting your valuable instruments

300ml

563706

500ml

not illustrated

563707



563706

Instrument Brush, Instrument Washer, MELISEPTOL



INSTRUMENT BRUSH

For the careful cleaning of the instruments,
plastic bristles
563708



INSTRUMENT WASHER MELACLEAN

- for cleaning, disinfecting, washing and drying instruments
- gentle cleaning
- protects the instruments
- saves time in preparation

Instrument cleaning and chemical disinfection system MELAclean incl. basket

562010

Special disinfection agent 6/box

562011

Rinse agent 6/box

562012

Instrument basket, small

562013

Instrument basket, large

562014

Small part container

562015



FAST-ACTING ALCOHOLIC SURFACE DISINFECTANT

Active against bacteria, mycobacteria, fungi and viruses (HBV / HIV / HCV, rota, adeno and vaccinia)

1 l bottle, spray heads to be ordered separately

563810

Spray head for MELISEPTOL

570310

Scrub Brushes, Alcohol- and Cotton Dispenser, Examination Tables

HAND/ELBOW DISINFECTANT DISPENSER

For 500ml STERILIUM bottles

570005

For 1l STERILIUM bottles

570010

Disinfectant wall dispenser TLS 22

570110



BRUSH DISPENSER FOR SCRUB BRUSHES

For 10 nailbrushes, autoclavable, stainless steel, wall mount

572010

Nailbrushes, 10/box, autoclavable (more than 400 times)

572110



ALCOHOL AND COTTON DISPENSER

Alcohol Dispenser, 250ml, handy pump

- easy alcohol dispensing

- sturdy brown jar

- with safety cover

574025

Cotton Dispenser, D = 100mm,

height = 100mm

- glass with metal cover

574210



EXAMINATION- AND TRANSPORTATION TABLE

- stainless steel top

- powder coated base

- L = 120 x W = 60 x H = 83cm

- easy to clean and disinfect

- top price performance

With 4 table-legs for a steady stand

600361

With 4 large lockable castors

600360



Examination Tables



EXAMINATION TABLE "EXTRA STRONG"

L = 130 x W = 60 x H = 90cm

This multi-use table is a solid stainless steel construction with 4 adjustable feet for perfect stability. A polished flat top with anti-drip edges and drain hole prevents mess and is easy to clean and disinfect. Table top with wooden plate underneath for a low-noise operation

600160

As 600160, with 4 large lockable castors

600165

VET Eickemeyer®

Large variety of surgery-
and examination tables



604160



604161



604165

EICKEMEYER SCISSOR-SHAPED EXAMINATION TABLE

The minimal operating height of 28cm allows large dogs to walk on the table.
 The maximum operating height of 105cm allows you to exam small patients without bending forward.

- electric operating table
- height adjustable from 28cm to 105cm with a high lifting capacity
- all metal parts are of high grade German stainless steel
- table remains very stable in any position
- smooth polished flat top (60cmx130cm) with anti-drip edges and drain hole

604160

4 lockable castors (D = 7.5cm), retrofit
not illustrated

604161

604160 with built-in scale
not illustrated

604180

604160 battery powered
 - 4 lockable castors, D = 7.5cm
 - specifications see 604160
not illustrated

604165

Surgery Table with "X-base"



SURGERY TABLE WITH X-BASE

- X-form base, high quality stainless steel
- surgery stool fits under the table
- easy on your back

As 601550, table top 50x130cm, electric operated
602012

As 601560, table top 60x130cm, electric operated
602010

As 601960, table top 60x130cm, hydraulic pump
602020

As 601950, table top 50x130cm, hydraulic pump
602022

V-Top Surgery Tables, Hydraulic Surgery Tables, Surgery Table Tops

SURGERY TABLE WITH V-TOP AND X-BASE

With stainless steel V-Top, 140x50cm and 2 side rails

- gas spring supported V adjustment from 0 to 90°
- one hand adjustment
- with tilt mechanism one direction approx. 75° degrees
- removable drain channel
- X-form base, high quality stainless steel
- self-contained, maintenance free height elevation with full 3-year warranty
- height adjustable from 72 to 112cm
- provides easy and safe positioning of the patient
- safe stand
- protection for your back during operations while seated

With electric height elevation

602060

With hydraulic pump height elevation

602070



HYDRAULIC SURGERY TABLE BASIC

With stainless steel table top 60x130cm

- height adjustable 63–115cm
- tilt mechanism/one direction appr. 80°
- rubber plate 124x64cm
- powder-coated base
- convenient for examinations
- easy to clean and disinfect
- safe stand

602355



SURGERY TABLE TOPS

- stainless steel table top
- anti-drip edges and drain hole
- silicon sealed
- table top with wooden plate underneath for low-noise operation
- easy to clean and disinfect

Stainless steel table top 50x130cm

602650

Stainless steel table top 60x130cm

602660

Stainless steel table top, flat 60x130cm without illustration

60419502

White polyethylene table top, 60x130cm

602760

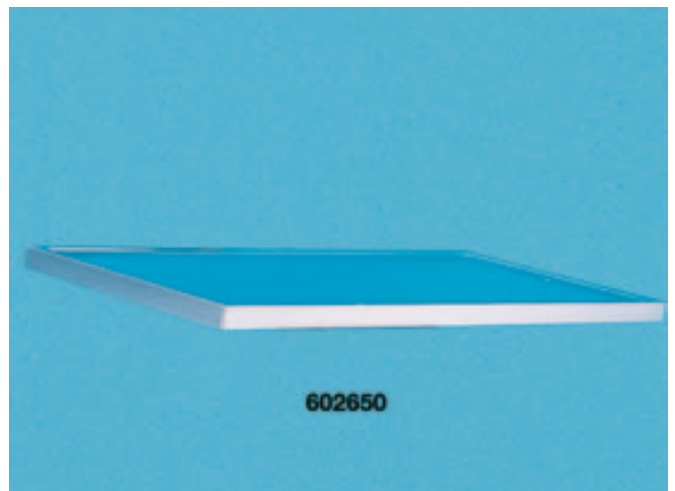

Rail Systems, Tie Down Attachments, Tray and IV Stand

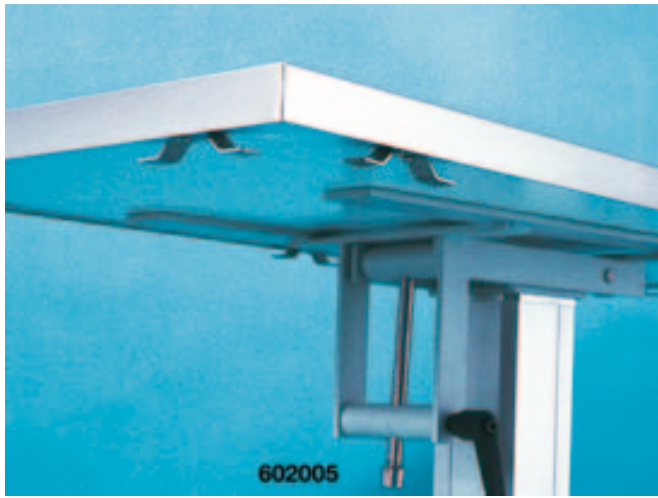

TIE DOWN ATTACHMENTS

- Safe restraint of the animals, set of 10 clamps
 - on each side of the table – 3 sideways and 2 crosswise
 - provides easy patient positioning
 - stainless steel
- 602005**



RAIL SYSTEM

- to hold quick release tie down attachments
- for fast, secure and variable restraint of animals on the table
- to apply further accessories

Sidewise, length = 120cm
605025

Crosswise, length = 50cm
605060



QUICK RELEASE TIE DOWN ATTACHMENTS

- Quick release tie down cleat for ropes
- fits on all rail systems

603800

- Quick release tie down cleat for ropes and IV stands, etc.

- D = 12mm
- fits on all rail systems

603802

Nylon ropes, D = 4mm, length = 100cm, 10/box
603841



TRAY AND IV STAND

To apply to a surgery table with rail system

Tray, 35x35cm, with attachment
605135

IV Stand, 120cm, with attachment
not illustrated
605200

Operating Table Frame, Stainless Steel Box, Rubber Mat, Buckets

OPERATING TABLE FRAME

- For table top with width = 50cm
- with two quick release cleats
- for secure tie down of extremities
- fits to rail system

605202



STAINLESS STEEL TRAY WITH REMOVABLE GRATE

For mounting on surgery tables with rail system

- height adjustable
- can also be used as an instrument tray

605100

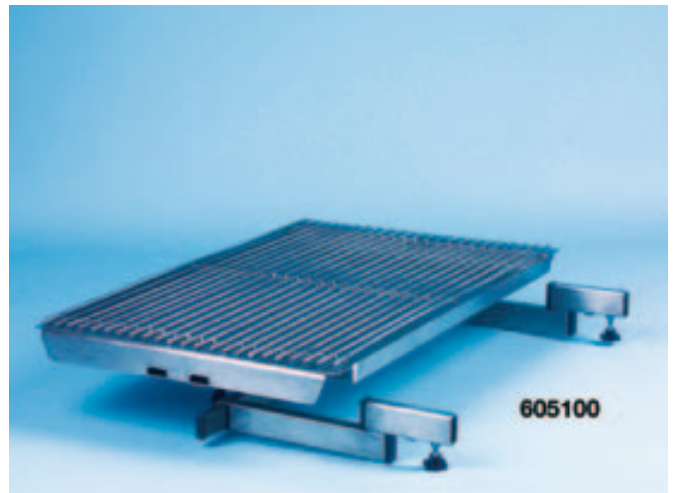

RUBBER MATS FOR SURGERY TABLES

- protects the table top
- non-slip
- comfortable for the patient
- round corners

Rubber mat, grey, 125x45.5cm for table tops 50x130cm

602150

Rubber mat, grey, 125x55.5cm for table tops 60x130cm

602160

Plastic mat, transparent, 125x45.5cm, for table tops 50x130cm

602250

Plastic mat, transparent, 125x55.5cm, for table tops 60x130cm

602260

STAINLESS STEEL BUCKET

- With free swinging handle
- easy to clean and disinfect

6 litre

602505

10 litre

602510



Hydraulic Surgery Table SHOR-LINE, Surgery Tables HEDO



603452

HYDRAULIC SURGERY TABLE SHOR-LINE

Stainless steel flat table top with hydraulic elevation

- height adjustable from 78 to 104cm
- table top is formed from one piece of heavy-gauge stainless steel with rounded corners
- drain outlet on the end with hook for attachment of an optional collecting pail
- 360° rotation
- complete stainless steel
- attachment rail system runs continuously along the sides and ends of the table
- for sliding, quick release, tie-down attachments are provided and can be tightened in any position along this rail

152x56cm

603452



603618

SURGERY TABLES HEDO

Surgery Table HEDO

Electric height adjustment on both ends: 72.5 to 92.5cm

- detachable, radiolucent table top, 134x39cm
- 4 fixation rails
- 4 lockable castors
- lifts up to 150kg
- 1 animal positioner
- 1IV Stand
- 4 quick release tie-down attachments
- 10 ropes, length = 1m
- option: electric tilt mechanism

603618

Surgery Table HEDO ,MIC'

Electric tilt, 30° both sides, electric height adjustment from 72.5 to 92.5cm

- specially designed for laparoscopic surgery
- detachable, radiolucent table top, 134x39cm
- 4 fixation rails
- 4 lockable castors
- lifts up to 150kg
- 1 animal positioner
- 1IV Stand
- 4 quick release tie-down attachments
- 10 ropes, length = 1m

603619

FOLDING WALL MOUNT SURGERY TABLE

Wall mounted and constructed completely in stainless steel

- easy to clean and disinfect
- The table measures 50cm long and 23cm wide
- perfect size for small animal procedures
- small and compact
- allows the surgeon easy access to the patient multiple adjustment of both height and operating angle
- 9 different height positions
- 8 different operation angles
- provides a comfortable operating position for the surgeon
- saving space

BREUER pattern
606020



CAT SURGERY TABLE ZIPS

Proven for decades!

- fits on every table
- non-slip stand
- fast and secure restraint with 4 elastic strips
- for cats and tomcats
- stainless steel

606000

Set of 4 rubber fixation strips

606004



Practitioner Chairs, Practitioner Stools



PRACTITIONER CHAIRS

- Practitioner Chair COBURG, round seat with backrest, black
 - foot controlled gas elevation from 60 to 83cm
 - anti-fatigue cushioning
 - large seat, D = 38cm
 - backrest adjustable in height and depth
- 610456**

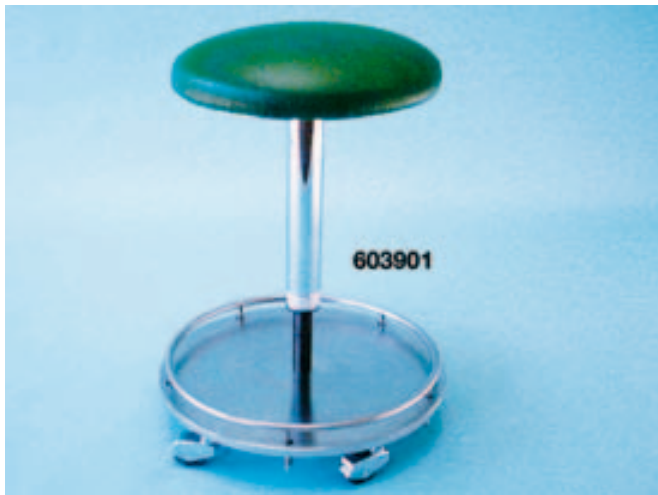

PRACTITIONER STOOL HEDO

- heavy baseplate, 27kg
 - extremely durable
 - foot controlled hydraulic elevation from 53 to 77cm
 - chrome-plated
 - mobile
 - coating material: velour or sleek leather, green or gray
- 603901**



PRACTITIONER STOOLS

- round seat, black
- comfortable seat
- easy height adjustment
- with 5-point mobile castor chrome base

Height adjustable from 45 to 55cm

610145

Height adjustable from 54 to 73cm

not illustrated

610173

Height adjustable from 46 to 62cm with foot ring

not illustrated

610154

PRACTITIONER CHAIRS

- adjustable backrest, black
- height adjustment from 46 to 62cm
- foot ring
- comfortable seating
- double castors for hard floors

610054



PRACTITIONER STOOL JOLLY

- height adjustable by gas elevation from 59 to 85cm
- easy to clean artificial leather cover
- smooth-running double castors

610150



PRACTITIONER STOOL JUMPER

- height adjustable by gas elevation from 59 to 85cm
- easy to clean artificial leather cover
- smooth-running double castors
- ergonomic construction provides comfortable seating

610155



PRACTITIONER CHAIR BARRAGE

- height adjustable by gas elevation from 52 to 72cm
- easy to clean artificial leather cover
- smooth-running double castors
- seat and backrest black
- armrest optional

Practitioner Chair

610160

Arm rest for Practitioner chair Barrage

610161



Practitioner Standing Aid, Practitioner Chairs, GAYMAR T/Pump



PRACTITIONER STANDING AID STEADY S

- height adjustable by gas elevation from 59 to 85cm
- seat adjustable (angle)
- easy to clean and to disinfect
- space saving storage due to fold-away base
- with foot rest

610165



PRACTITIONER CHAIRS MEDICAL

- height adjustable by gas elevation from 49 to 69cm
- comfortable seating
- easy to clean artificial leather cover
- smooth-running double castors
- seat and backrest black



GAYMAR T/PUMP HEATING SYSTEM

For keeping your patient's temperature normal during surgery

- more safety during anaesthesia
- temperature can be adjusted from 25° to 41°C
- easy fill adapter

GAYMAR T/PUMP including water pad, 53x38cm

648060

Water pad, 53x38cm

648061

HEATING PAD

- more safety during anaesthesia
- temperature can be adjusted from 25° to 42°C
- constant heat distribution
- sturdy pad

Control unit for heating pad

648070

Heating Pad 440x680mm for control unit

648070

648071

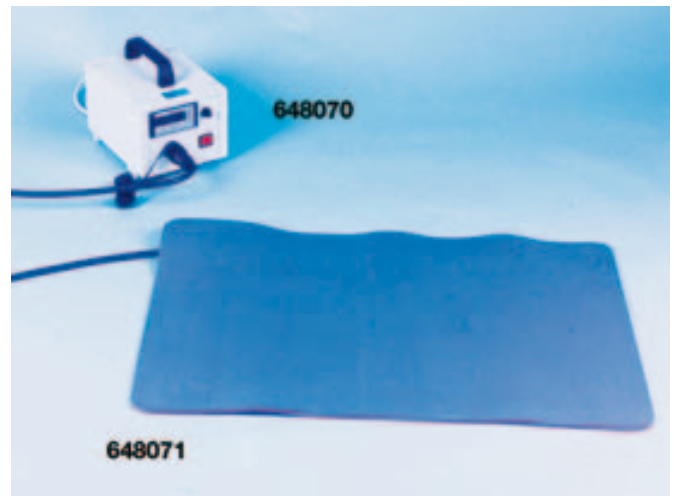

VACUUM SUPPORT

V-form, ideal for positioning during eye surgery

- reinforced nylon for high tear resistance
- smooth edges

605911



HEATING PAD

- more safety during anaesthesia
- temperature can be adjusted from 28°/32°/36°/41°C
- autoclavable
- 180x70 cm

648050

Cover for 648050

648051



VACUUM SUPPORT

Holds patients in position for surgery and helps prevent heat loss. With safe and durable nylon cover

30x60cm

605935

50x100cm

605945

Carrying cover for vacuum support 50x100cm (605945)

605950

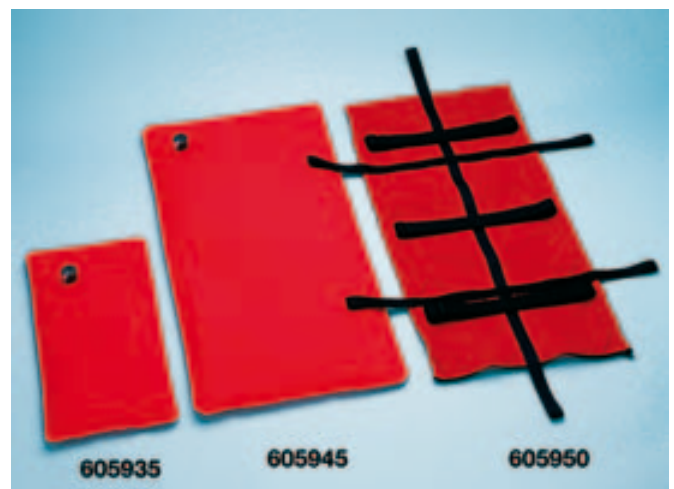

Vacuum Supports, Vacuum Support Pump, Animal Stretcher



VACUUM SUPPORT

Holds patients in position for surgery and helps prevent heat loss

- safe and durable nylon
- 4 handles to carry the animal
- 3 Velcro straps for additional restraint of the patient
- 80x100cm

605980



VACUUM SUPPORT PUMP

Fits on every EICKEMEYER vacuum support

- robust and durable PVC
- for easy extraction of air by suction

605990



ANIMAL STRETCHER WITH FRAME

For small animals, 120x52.5cm

- ideal for emergencies, after surgery transport and injury
- dirt-resistant, durable reinforced nylon cover
- Velcro restraint straps
- collapsible lightweight frame

605995



ANIMAL STRETCHER WITH MOBILE PLATFORM

L = 120 x W = 52.5 x H = 80cm, with

- 4 swivelling castors (two lockable castors)
- large wheels, easy to manoeuvre
- removable top

605998



EQUINE SURGERY TABLE EICKEMEYER

- Equine surgery at it's best. Height adjustable from 32cm to 112cm
- designed by surgeons for surgeons
 - easy access to patient due to slim centre port
 - seamless padding for easy cleaning
 - extra thick padding
 - stepless height adjustable and tilt up to 25° – ideal for laparoscopy
 - battery powered (with charger)
 - easy to move
 - 4 lockable castors
 - 4 leg poles
 - dimension: length = 290cm, width = 105cm
 - lifting capacity = 1.300kg
 - weight = 420kg
- 608750**

Transport Slings, Inflatable Support, Equine Head Protection



TRANSPORT SLING FOR EQUINE SURGERY TABLE

Small, pair
608660
Large, pair
608670



INFLATABLE SUPPORT FOR EQUINE SURGERY TABLE

- durable, black rubber
- prevents neural paralysis during operation

Custom design –
PLEASE ASK FOR MORE DETAILS
608650

Inflator, 220V
not illustrated
608502



EQUINE HEAD PROTECTION

Complete leather, handmade, modified by
GROSSE-LEMBECK

- protects the head during surgery, recovery etc.
- fits all horses
- heavy duty leather
- durable and long lasting

211400

EXAMINATION LIGHT HEINE HL 5000

- bright, white light
- 140.000 Lux at 30cm
- solid construction with high-specification 120cm radius
- gooseneck design provides easy handling and precise positioning
- economical halogen bulb which lasts at least 4000 hours
- increased safety during examination due to a UV-filter

Wall mounted model

611100

Rail mounted model

611110

Mobile stand model, heavy

611120



EXAMINATION LIGHT MACH 120 / 120F

Lamp for practice and hospital with superior colour rendering

- high quality, easy-to-use universal examination lamp
- housing diameter: D = 150mm
- MACH 120: 26.000 Lux at 80cm
- illumination field: D = 14cm at 100cm
- light system: R86
- MACH 120F: 30.000 Lux at 80cm
- focusable illumination field: D = 10 to 23cm at 100cm
- light system: R96

MACH 120, stand model, short arm

611250

MACH 120F, stand model, short arm

611251

MACH 120, wall mounted model

611253

MACH 120F, wall mounted model

611254

MACH 120, ceiling mounted model, up to 3m ceiling height

611255

MACH 120F, ceiling mounted model, up to 3m ceiling height

611252

MACH 120, stand model "Swing"

611256

MACH 120F, stand model "Swing"

611257



Surgery Light



SURGERY LIGHT TRIAFLEX / TRIAFLEX R96

Operating lamp for minor and middle surgery with superior colour rendering

- 3 halogen bulbs, 40 Watt each, for high illumination
- brightness adjustable with a 2-step-switch
- housing diameter: D = 40cm
- economical long-lasting halogen bulbs
- working distance: 70 to 140cm
- also available as duo-light
- TRIAFLEX: 50.000 Lux at 100cm
- illumination field: D = 20cm at 100cm
- light quality: R86
- TRIAFLEX R96: 60.000 Lux at 100cm
- focusable illumination field: 15 to 23cm at 100cm
- light quality: R96

TRIAFLEX, stand model with swivel arm, range = 80cm

612020

TRIAFLEX, wall mounted model with swivel arm, range = 175cm

612120

TRIAFLEX, ceiling mounted model, up to 2.5m ceiling height, range = 165cm

612220

TRIAFLEX, ceiling mounted model, up to 3m ceiling height, range = 165cm

612221

TRIAFLEX, ceiling mounted model, up to 3.5m ceiling height, range = 165cm

612222

TRIAFLEX, ceiling mounted model, up to 4m ceiling height, range = 165cm

612223

TRIAFLEX R96, stand model with swivel arm, range = 80cm

612021

TRIAFLEX R96, wall mounted model with swivel arm, range = 175cm

612121

TRIAFLEX R96, ceiling mounted model, up to 2.5m ceiling height, range = 165cm

612228

TRIAFLEX R96, ceiling mounted model, up to 3m ceiling height, range = 165cm

612227

Replacement handle for TRIAFLEX / TRIAFLEX R96 as from 1999 model, sterilisable

612229

SURGERY LIGHT MACH M2 / M2F

Examination and small surgery light with superior colour rendering, similar to daylight

- maintenance free
- smooth running
- state of the art
- working distance: 70 to 140cm
- MACH M2: 60.000 Lux at 100cm
- illumination field: D = 18cm at 100cm
- light system: R96
- MACH M2F: 90.000 Lux at 100cm
- focusable illumination field: 14 to 24cm at 100cm
- light system: R96

MACH M2, ceiling mounted model, up to 3m ceiling height

612300

MACH M2F, ceiling mounted model, up to 3m ceiling height

612305

MACH M2, wall mounted model

612301

MACH M2F, wall mounted model

612306

**SURGERY LIGHT TRIGENFLEX / TRIGENFLEX R96**

Operating lamp for major surgery with superior colour rendering

- 3 halogen bulbs, 50 Watt each, for high illumination
- minimal heat accumulation in head area
- minimal temperature increase on the surgical area
- economical long-lasting halogen bulbs
- working distance: 70 to 140cm
- also available as duo-light
- focusable illumination field: 15 to 26cm at 100cm
- TRIGENFLEX: 100.000 Lux at 100cm
- light system: R86
- TRIGENFLEX R96: 125.000 Lux at 100cm
- light system: R96

TRIGENFLEX, ceiling mounted model, up to 2.7m ceiling height, range = 165cm

612626

TRIGENFLEX, ceiling mounted model, up to 3m ceiling height, range = 165cm

612625

TRIGENFLEX R96, wall mounted model, with swivel arm, range = 175cm

612526

TRIGENFLEX R96, ceiling mounted model, up to 2.7m ceiling height, range = 165cm

612628

TRIGENFLEX R96, ceiling mounted model, up to 3m ceiling height, range = 165cm

612627



Surgery Light



SURGERY LIGHT MACH M3 F / M3 DF

Operating lamp for minor and middle surgery with superior colour rendering

- illuminate specific points in the deepest wound channels with high-intensity light from 3 halogen bulbs, 50 Watt each
- precise adjustment of the illumination field
- single handed adjustment of the merging of luminous fields and focusing as well as the activation of the Auto-Focus function (only M3 DF) with sterilisable handle
- light system: R96
- integrated video system option available
- MACH M3 F: 100.000 Lux at 100cm
- focusable illumination field: 17 to 28cm at 100cm
- working distance: 70 to 140cm MACH M3 DF: 130.000 Lux at 100cm
- focusable illumination field: 12 to 30cm at 100cm
- working distance: 60 to 150cm

MACH M3 F, ceiling mounted model, for 2.71m up to 3m ceiling height

612801

MACH M3 DF, ceiling mounted model, from 2.71m up to 3m ceiling height

612802

612805

On/Off switch, integrated arm mount, for MACH 380/400/500 and M3

612808



SURGERY LIGHT WITH LED-TECHNOLOGY

MACH M3 LED

- Light intensity (lux): 130.000
- Colour rendering index R(a) general: 95
- Colour rendering index R(9) red: ≥ 90
- Focusable light-field size (mm): 170-280
- Colour temperature (Kelvin): 3750, 4000, 4250, 4500, 4750
- Electronic light intensity control at lamp head: standard
- Temperature increase in head area: 0,5°C
- Number of LEDs: 112
- Power consumption: 120 VA
- Working distance (mm): 700-1400
- Height adjustment (mm): 1180

612900

SURGERY LIGHT WITH LED-TECHNOLOGY

MACH M5 LED

- Light intensity (lux): 160.000
- Colour rendering index R(a) general: 95
- Colour rendering index R(9) red: ≥ 90
- Focusable light-field size (mm): 200-320
- Colour temperature (Kelvin): 3750, 4000, 4250, 4500, 4750
- Electronic light intensity control at lamp head: standard
- Temperature increase in head area: 0,5°C
- Number of LEDs: 160
- Power consumption: 160 VA
- Working distance (mm): 700-1400, 600-1500
- Height adjustment (mm): 1180

612950



CEILING MOUNT RING

- necessary for all ceiling mount lights
- for secure mounting of lights on the ceiling
- easy installation

D = 300mm, for single lights

612730

D = 400mm, for dual lights

612731

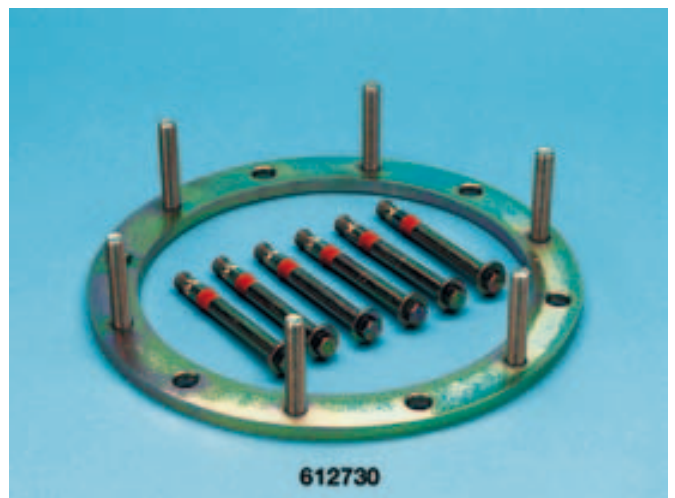

MEDICAL CABINET WITH NARCOTIC SAFE

White powder coated steel

Dimensions: H: 56cm × W: 46cm × D: 18cm

- complete with double door protection for narcotics
- individual key for each door
- economical price

620510



Instrument Cabinet, Syringe and Cannula Dispenser, Instrument Tables



INSTRUMENT CABINET

With two folding doors

Dimensions:

H = 175cm × W = 100cm × D = 45cm

- metal cabinet with two glass doors
- 3 adjustable glass trays
- surface easy to clean and to disinfect

621200



SYRINGE AND CANNULA DISPENSER

- for storage of syringes and needles
- stackable
- swivelling containers
- white

Syringe and cannula dispenser, one each

62400001

Canula dispenser, 5 boxes

W = 60×D = 10×H = 16cm

62400101

Syringe dispenser, 3 boxes

W = 60×D = 16×H = 24cm

62400201



INSTRUMENT TABLE

Stainless steel

- height: 80cm
- 4 swivelling castors
- easy to clean and disinfect
- safe stand
- Dimensions = 65×45 cm

625050

VARIOCAR ALL-PURPOSE SIDE TABLE

With one drawer, white, H 83×W 60×D 45cm

- options of up to 4 drawers available

625083

Side Table ECONOMY with one drawer

625084



MEDICAR – FOR MORE SPACE AND ORGANISATION

- with 2 pivoting drawers

- dimensions: H = 74 × W = 43 × D = 41cm

- 5 swivelling castors

625095



MAJO INSTRUMENT TABLE

Stainless steel

- top: 40×60cm

- height adjustable from 90 to 132cm

- with 4 lockable castors

- easy to clean and disinfect

625160











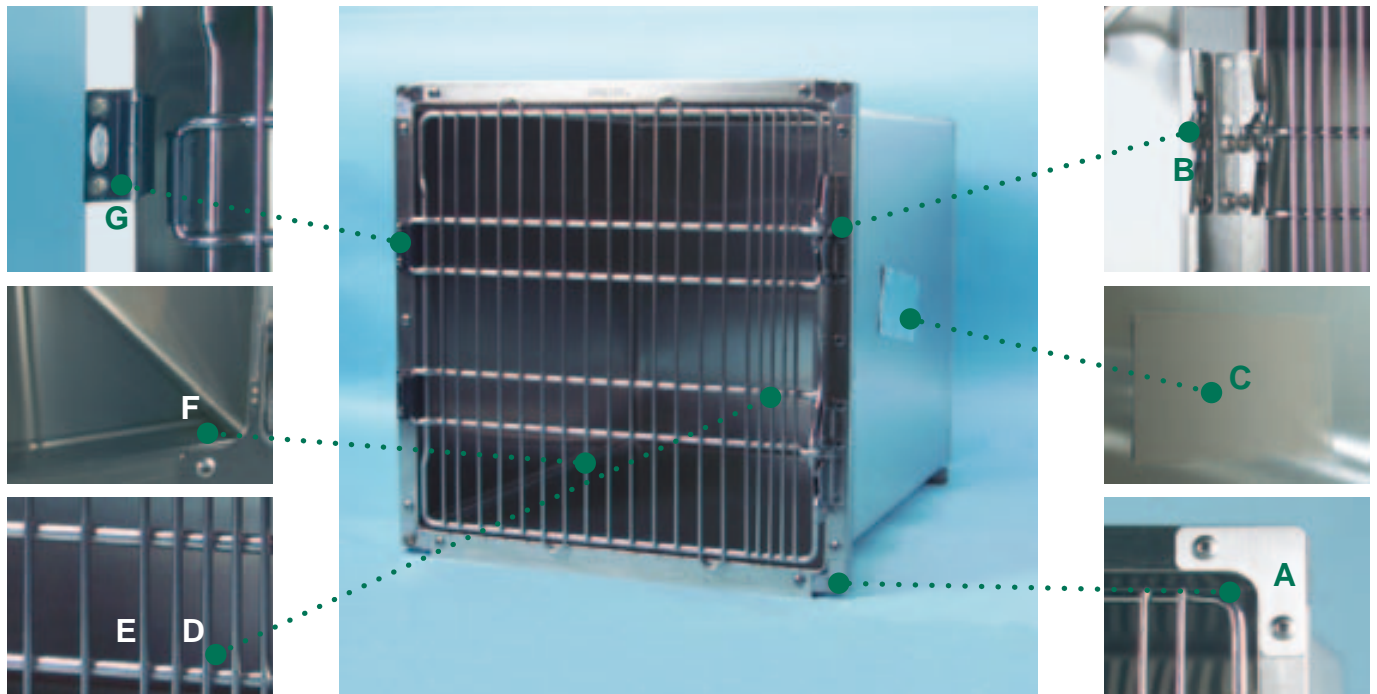

Built to last a lifetime

SHOR-LINE kennels are fabricated in an exclusive 2-piece unitized construction process, minimizing the number of welded seams. Less seams mean stronger kennels that are built to last. Only finest stainless steel material being used to provide you with a lifetime of service.





Kennel Sizes

Art.No.		Width in mm	Height in mm	Depth in mm	
631545 631645		457 457	457 610	718 718	
631761 631861		610 610	457 610	718 718	
631961 632076		610 762	762 610	718 718	
632176 632276		762 762	762 914	718 718	
632491 632591		914 914	762 914	718 718	
632612 632712		1219 double 1219 door	762 762	718 718	
632812 632912		1219 double 1219 door	914 914	718 718	
633015 633118		1224 double 1224 door	914 914	718 718	

(A) Trim Hardware

All trim plates and trim strips are solid stainless steel with rounded corners-no sharp edges or points. Patents pending.

(B) Patented Latch

Our latch is designed to be durable, secure and quiet. Acetal bushings provide smooth operation and sound dampening qualities. Concave latch bar allows cage door to be opened with your forearm when handling a sedated or fractious pet with both hands. Shor-Line has been granted U.S. Patent #5,097,796 for this unique latch design.

(C) Sound Dampening

New sound and vibration absorbing technology. Standard equipment on all Shor-Line cages.

(D) World's Mightiest Cage Door

The one piece frame and wrap around hinge/latch bars are formed from 3/8" diameter solid stainless steel rods. All additional horizontal rods are 1/4" in diameter and all vertical rods are 3/16" in diameter. Every intersection of horizontal and vertical rods are welded, providing incredible strength. Electro polishing is the final process resulting in a smooth and bright finish that looks great and is easy to clean...and practical too! Loops on the door prevent paper, pads or towels from sliding out the front of the cage.

(E) Fully Rounded Corners and Fluid Retaining Lip

No 90° corners to trap germs and debris. A smooth rounded cove transitions the back and all internal sides of the cage. A slightly raised, fluid retaining lip prevents drainage out the front of the cage.

(F) Stainless Steel Frame

All frame members are heavy duty stainless steel channel to provide you many years of solid structural support for your cage assemblies. All edges and corners on our frames have been radiused and de-burred.

(G) New, Patent Pending Hinge Design

The hinge is constructed of 14 gauge austenitic stainless steel that is encapsulated by an injection molded, fiberglass reinforced 6/6 thermoplastic polymer. The snap together bushing on the door frame is also molded from 6/6 thermoplastic polymer with permanent, self-lubricating properties resulting in a silky smooth and silent swing...truly "cutting edge" technology.

SHOR-LINE Kennel Accessories



SHOR-LINE STATIONARY PLATFORMS

Designed as a part of the modular system, these stainless steel stationary platforms are equipped with adjustable feet in each leg, to easily facilitate levelling. For planning purposes, allow for a 23.5 height increase when adjustable feet are fully extended

To fit 457mm wide Kennels

634204

To fit 610mm wide Kennels

634206

To fit 762mm wide Kennels

634207

To fit 914mm wide Kennels

634209

To fit 1219mm wide Kennels

634212

To fit 1524mm wide Kennels

634215

To fit 1829mm wide Kennels

634218



MOBILE PLATFORMS

If you want to move your Kennel banks for cleaning or rearranging, these stainless steel mobile platforms with 4 heavy duty 360° swivelling castors (2 lockable castors) will make it easy

To fit 457mm wide Kennels

634004

To fit 610mm wide Kennels

634006

To fit 762mm wide Kennels

634007

To fit 914mm wide Kennels

634009

To fit 1219mm wide Kennels

634012

To fit 1524mm wide Kennels

634015

To fit 1829mm wide Kennels

634018



REMOVABLE KENNEL DIVIDERS

Converts your double door kennels into two smaller units. The solid stainless steel divider connects to a bracket at the back of each kennel for secure separation between compartments

To fit 762mm high Kennels

635776

To fit 914mm high Kennels

635891

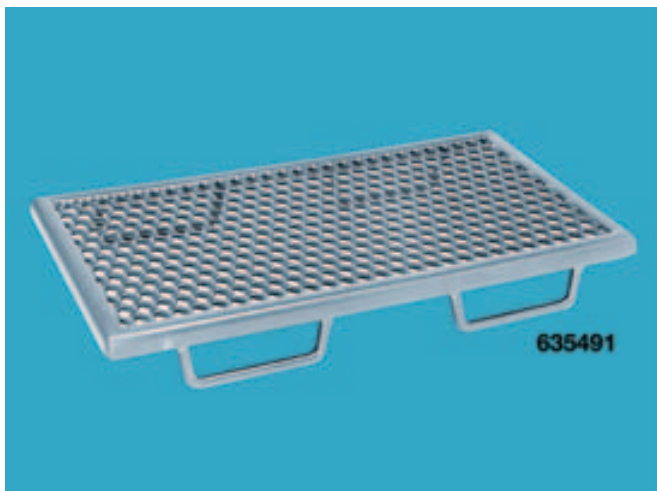

GRILL FLOOR

PVC coated

- ensures that the patient is kept dry and off the kennel floor
- clean the kennel floor w/o disturbing or removing the patient
- coated with non-porous, autoclavable PVC
- approved for food and animal use
- floors for double-door kennels are 2-piece

To fit 457mm wide Kennels

635145

To fit 610mm wide Kennels

635261

To fit 762mm wide Kennels

635376

To fit 914mm wide Kennels

635491

To fit 1219mm wide double door Kennels

635612

HEATING LAMP WITH MOUNTING

Fits on SHOR-LINE Kennel doors and keeps the animal warm e.g. after surgery

Infrared Heating Lamp

645000

Mounting for Infrared Heating Lamp

645002

Spare Bulb for Infrared Heating Lamp

645001



CARD HOLDERS

Simply attach to the bar of any SHOR-LINE Kennel door

Small, 76×127mm

636507

Large, 127×203mm

636512

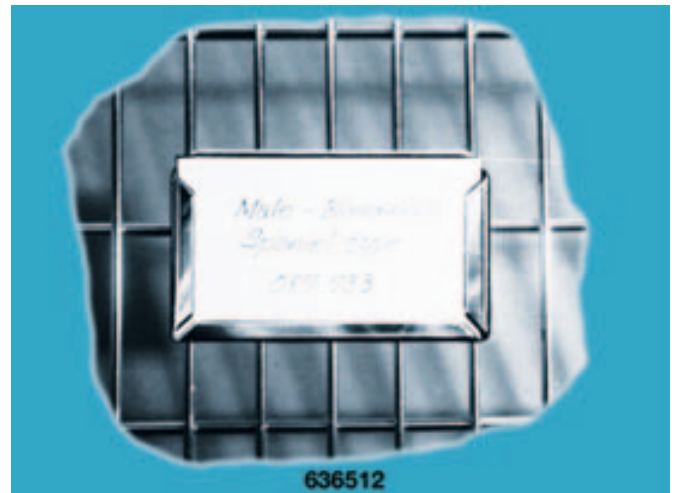

RECORD HOLDERS

Keep records ready at a glance. These Record Holders with clip keep patient records securely attached to any SHOR-LINE kennel door

Small, 140×190mm

636519

Large, 229×305mm

636530



DRUG BOX

- to put on a kennel
- drugs are ready to hand

Small, 140×266mm

639226

Large, 228×380mm

639238



SHOR-LINE Kennel Accessories



IV HOLDER

Easily attached to kennel door and holds standard infusion bags. A special spring loaded locking device allows convenient, single handed height adjustment

Small, length = 483mm

637000

Large, length = 889mm

637005



DELUXE WATER & FEED BOWLS

These heavy-duty polished stainless steel bowls are easy to clean. They are designed with a slight taper to be nested for maximum storing convenience.

Including mounting brackets for SHOR-LINE Kennel doors.

636018



CAT PERCHING SHELF

Adjustable to fit 457mm, 610mm & 762mm Kennels, depth = 178mm

636645



OXYGEN THERAPY DOORS

Can easily be hung on the existing door
- for intensive care and oxygen therapy
- with humidity and temperature display
- to connect to oxygen cylinders or oxygen concentrators

610×760mm, for SHOR-LINE Kennels 632712 and 631961 (2×)

636695

610×610mm, for SHOR-LINE Kennel 631861

636696

VETARIO INTENSIVE CARE UNITS

The VETARIO Intensive Care Unit provides the ideal environment to give your patients the best possible chance of a successful recovery

- infinite variable temperature adjustment from 20 to 45°C
- heating is held constant by an advanced proportional band controller
- temperature is digitally displayed
- air is gently fan circulated through a dust filter to ensure sufficient filtered fresh air and even temperature
- observation of patients is aided by a low power internal light
- easy to clean, durable and quick to set up
- lightweight, assures high flexibility

VETARIO S10, Floor = 370mm dia,
minimum height = 345mm

219020

VETARIO S20, Floor = 680×430mm,
minimum height = 450mm

219025



219020

DISINFECTING AND CLEANING AGENT

For stainless steel kennels, 5 litre bottle

637500



637500

SHOR-LINE Polykennel, Tub/Tables



SHOR-LINE "QUICK CLEAN" PLASTIC KENNELS

Precisely engineered to meet your requests for an alternative approach to animal cages. Using technically advanced materials for durability and sanitation, the corrosion-resistant Shor-Line plastic cages are the perfect alternative for your animal holding areas. These cages are ideal for animal holding after bathing or grooming, or to add to your existing holding cage system

- good value alternative
- rounded edges
- sturdy plastic
- zinc plated doors
- one-hand lock Including:
- 2 kennels 616×717mm
- 1 kennel 1232×875mm with double door
- 1 divider
- 1 mobile platform

634803



TUB/TABLE SHOR-LINE

Many procedures in your practice require extensive clean-up like dentistry, surgery prep, minor surgery, necropsy, hydro-therapy and grooming, just to name a few.

All of these procedures become easier, cleaner and more efficient when performed on a SHOR-LINE Multi-purpose Tub/Table.

- special "knee-space design" improves comfort during procedures
- stainless steel tub, depth = 152mm
- wooden corpus
- lower cabinet provides you with roomy storage
- optional table top No. 639060

639053



TUB/TABLE SHOR-LINE

- special "knee-space design" improves comfort during procedures
- all components made of stainless steel
- lower cabinet provides you with roomy storage (3 drawers, 1 cupboard)
- removable grid allows use as a bath tub for dogs
- easy to clean and disinfect
- shapely design
- w/o lavatory taps

639054

KENNEL RUNS – THE SOLUTION FOR YOUR KENNEL PROBLEMS

You can select from our broad range of standard sized gates, side panels, back panels and accessories. And, we've got designs to fit your every need. Raised floor systems and block wall systems are available, or order 'A la Carte' modular components.

Whatever your situation, you can be assured we'll work with you to provide the most effective set-up for your facility. And, all our run components are guaranteed to provide you the highest quality product available in the industry.

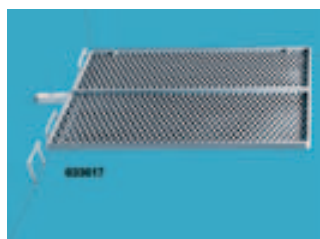

FOLD FLAT CAGES

With tray, zinc plated for a long life

L = 64 × W = 48 × H = 55cm

641053

L = 79 × W = 56 × H = 63cm

641276

L = 94 × W = 64 × H = 71cm

641290



PET CARRIER

Excellent carrier for cats, small dogs, puppies, hamsters, rodents etc.

- white plastic coated wire for extra durability

- with handle for easy carriage.

- easy to clean L = 45 × W = 30 × H = 30cm

- w/o plastic tray

642000

Cat Restraint

- helps to restrain cats in the pet carrier

- ideal for immunisation of uncooperative patients

404385



Trays for Pet Carrier, Mobile Stand for Pet Carriers, Pet Carriers, Cats Cradle

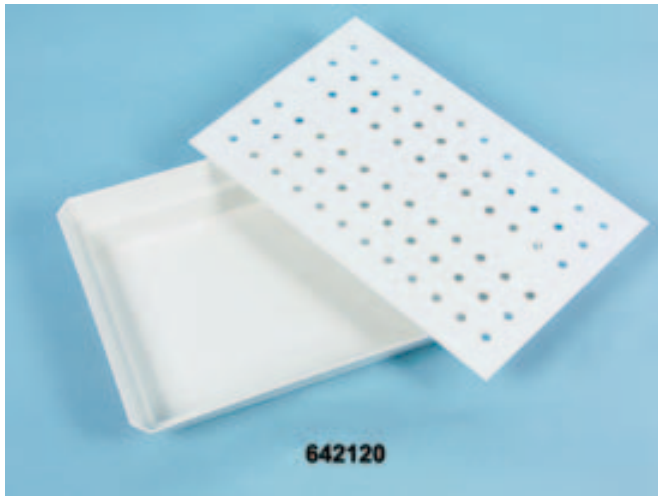

TRAYS FOR PET CARRIER

Fits perfectly into the pet carrier and collects litter

High Plastic insert with perforated, removable bottom
642120



MOBILE STAND FOR PET CARRIERS

For 4 Pet Carriers

- stainless steel
- 4 lockable castors
- easy removal of each kennel

643050



PET CARRIERS

Ideal for the transport by car, aeroplane, bus or train

- lock mechanism
- 2 removable spacious storage possibilities
- the door can be opened from both sides
- colour: beige
- accepted by nearly all airlines

Size 4, for dogs up to 25kg, 71×50×51cm
642564

Size 5, for dogs up to 40kg, 82×57×60cm
642565

Size 6, for dogs up to 50kg, 93×65×68cm,
642566

Size 7, for dogs more than 50kg, 105×75×79cm
642567



CATS CRADLE

To hang on the radiator

- soft padding
- easy to clean
- cats love it!

644560

HEATING PAD

- For small animals, 40×35cm
- maintains animal temperature
 - max. temperature equals the skin temperature of the animal
 - water resistant
 - long term usage
- 648040**



VET BED

- Ideal padding for your patients in kennels
- machine washable
 - absorbs fluids
 - keeps your patients dry
 - white

60×70cm

648201

70×100cm

648202

Sold by the meter, width = 140cm

648203

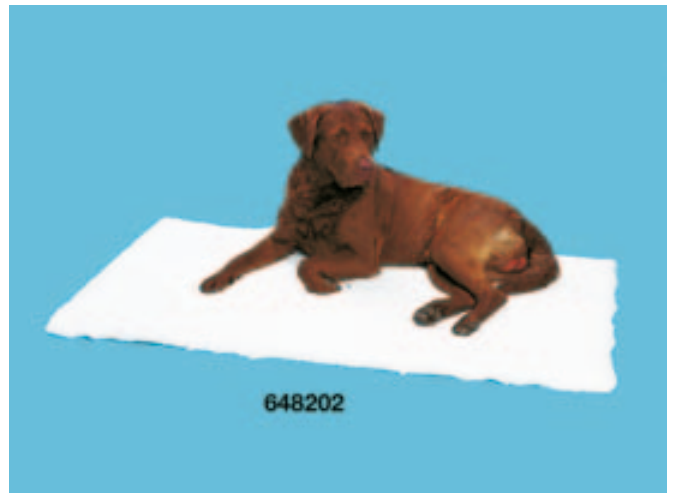

VET Eickemeyer®
Medizintechnik für Tierärzte





701115

HIGH FREQUENCY X-RAY UNIT HIRAY PLUS

One of the smallest and most powerful portable High Frequency X-Ray Units in the world!

- high output: max 100kV, max 30mA, 2kW inverter system
- compact and lightweight: 28×16.3×16cm / only 7.8kg
- easy and quick kV and mAs selection with rotary switches
- kV settings from 40–100kV (2kV steps) with illuminated LCD-Display
- 32 mAs settings, 0.3–20mAs, with illuminated LCD-Display
- anatomical programming of 8kV/mAs combinations
- focus = 1.2×1.2mm
- extra bright collimator light (100 lux at 1m) with automatic timer
- integrated laserpointer for distance measuring
- with 2-step manual control switch with curled cable, length = max 2.5m
- CE-Certificated
- supplied in a sturdy aluminium case

701115

Foot switch for HiRay Plus

not illustrated

701121



701100

HIGH FREQUENCY X-RAY UNIT HIRAY HIPOWER

Portable high power for brilliant X-Rays

- high output: max 100kV, max 32mA, 3.5kW inverter system
- easy and quick kV and mAs selection with rotary switches
- large display to adjust kV and mAs
- kV settings from 40–100kV (1kV steps) automatic mAs control
- 24 anatomical programmes, easy to control with one button each
- focus: 2×2mm
- two integrated laserpointer for precise distance measuring
- extra bright collimator halogen light with automatic timer
- compact and lightweight: L = 35 × W = 22 × H = 22cm / 18kg
- CE-Certificated
- supplied in a sturdy aluminium case

701100



HIGH FREQUENCY X-RAY UNIT HIRAY LIGHT

Ultra compact and lightweight portable X-Ray Unit – ideal for equine practitioners

- output: 16mAs / 40–60kV, 15mAs / 40–80kV
- ultra compact and lightweight: 27×14×15cm / only 5kg
- easy and quick kV and mAs selection with slide switches
- display to adjust kV and mAs
- mAs settings, 0.32–30 mAs
- anatomical programming of 8kV/mAs combinations
- focus: 1mm
- bright collimator light with automatic timer
- integrated laserpointer for distance measuring
- with 2-step manual control switch with curled cable
- CE-Certificated
- supplied in a sturdy aluminium case

701110

X-RAY STAND FOR PORTABLE X-RAY MACHINES

- height adjustable
- safe stand
- 4 locking castors
- complete stainless steel

X-ray Stand, large

701118

Short rod for X-Ray Stand, 120cm, for horses

701411



X-RAY STAND WITH LIFTING SUPPORT

- for portable X-Ray machines
- lifts up your X-Ray machine easily
- with long and short rod
- will dismantle for easy transportation
- stainless steel
- 4 lockable castors
- easy to clean
- lightweight

X-Ray Stand, 195cm

701400



X-Ray Stands, X-Ray Tables



X-RAY STAND

- X-Ray Stand with short rod, 120cm, for horses
- for portable X-Ray machines
- height adjustable
- will dismantle for easy transportation
- stainless steel
- 4 lockable castors

701410

Long rod for X-Ray Stand, 180cm, for small animals

701412



WALL MOUNTED X-RAY STAND WITH X-RAY TABLE

Wall Mounted Stand

- for portable X-Ray machines
- height adjustable
- self centred cassette tray for perfect alignment

701450

X-Ray Table for 701450

- radiolucent table top
- stainless steel frame
- 4 lockable castors
- L = 120 × W = 60 × H = 86cm
- colour: white

701455



X-RAY TABLE WITH STAND

For all major portable X-Ray machines

- radiolucent table top, 160×76cm, height: 67cm
- stainless steel frame
- self-centering cassette tray
- stand and cassette tray on runners cover more than 80% of the length of the table

701470



STATIONARY HIGH FREQUENCY X-RAY UNIT EICKEMEYER

- High-capacity stationary X-Ray Unit with touch-screen control
- very powerful 32kW, 100kHz, 425 mAs
- kV selection 40–99kV (1kV steps)
- mAs selection 0.2–100 mAs
- standard Pre-Sets for different animals (automatic anatomical programming)
- standard power supply 220V / 16 A, condensor backed
- includes grid 8:1, aluminium
- large focus: (1.3×1.3mm) 40–80kV / 400 mA 81–100kV / 320 mA
- small focus: (0.6×0.6mm) 40–50kV / 200 mA 51–60kV / 160 mA
- 4 way floating table top, 75×150cm

701030

X-Ray Film



EICKEMEYER X-RAY FILM, GREEN

- increased speed results in lower mA settings and reduces radiation exposure
- unparalleled detail
- best quality
- 100/box

13×18cm

701913

18×24cm

701918

20×40cm

701920

24×30cm

701924

30×40cm

701930



EUROMED X-RAY FILM, GREEN

- highest quality
- unparalleled detail and information
- 100/box
- best price performance

13×18cm

702313

18×24cm

702318

20×40cm

702320

24×30cm

702324

30×40cm

702330

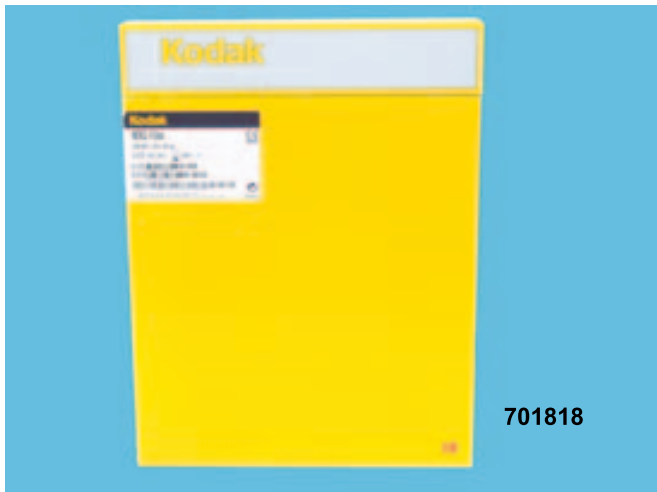

KODAK MXG X-RAY FILM

- highest quality
- unparalleled detail
- 100/box

18×24cm

701818

24×30cm

701824

30×40cm

701830



FERRANIA XDA PLUS X-RAY FILM

- highest quality
- unparalleled detail
- 100/box

18×24cm

702018

24×30cm

702024

30×40cm

702030

Intensifying Screens, Screen Cleaner, X-Ray Cassette

EICKEMEYER INTENSIFYING SCREENS, GREEN

- high diagnostic clarity
- high contrast
- excellent image quality

EICKEMEYER 200, 13×18cm

703413

EICKEMEYER 200, 18×24cm

703418

EICKEMEYER 200, 20×40cm

703420

EICKEMEYER 200, 24×30cm

703424

EICKEMEYER 200, 30×40cm

703430

EICKEMEYER 400, 13×18cm

703113

EICKEMEYER 400, 18×24cm

703118

EICKEMEYER 400, 20×40cm

703120

EICKEMEYER 400, 24×30cm

703124

EICKEMEYER 400, 30×40cm

703130

SCREEN CLEANER

250ml, fluid

- extend the life of your intensifying screens
- antistatic

703110

EICKEMEYER X-RAY CASSETTE

- light weight
- easy to open and close
- protective back coating
- highest quality

13×18cm

702413

18×24cm

702418

20×40cm

702420

24×30cm

702424

30×40cm

702430

35×43cm

702435



703113



703110



702424

Grid, Lead Divider, X-Ray Positioners

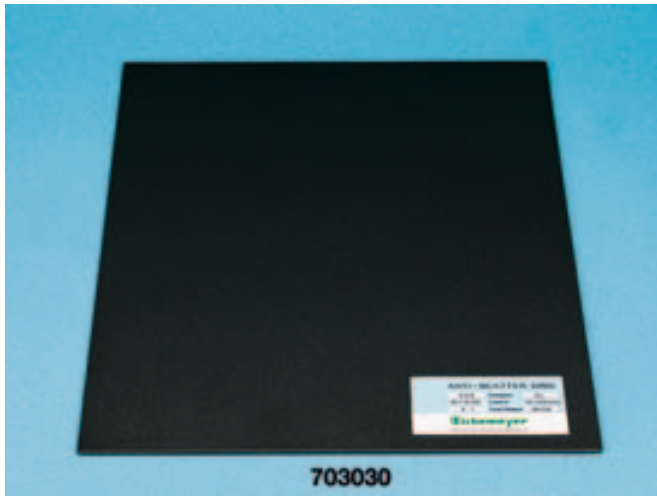

GRID

- reduces scattered radiation
- 40 lines/cm, parallel
- focus ratio 8:1
- protective back coating
- aluminium lamellae
- film-focus distance: 80 to 100cm

18×24cm

703018

24×30cm

703024

30×40cm

703030

43.5×47.5cm

703043



LEAD DIVIDER

To cover 50% of the cassette

For 24×30cm cassettes

703224

For 30×40cm cassettes

703230

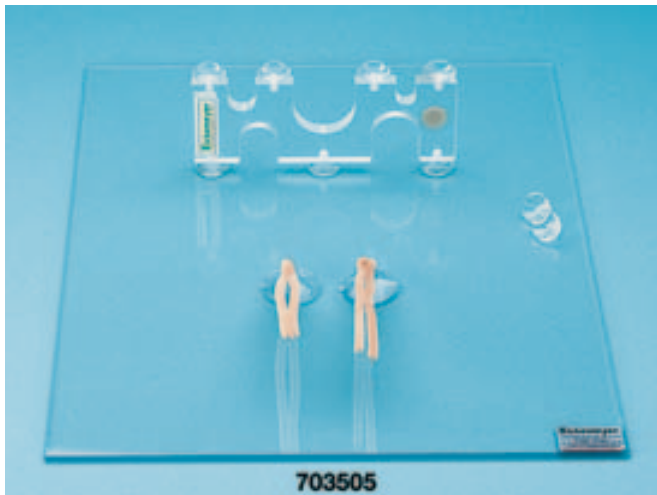

AVIAN X-RAY POSITIONER

Convenient for all bird sizes

- made of durable Plexiglas
- also a safe restraint for surgery

703505



WOODEN X-RAY POSITIONER

- ideal for positioning
- adjustable to all sizes required

703510

X-Ray Positioners, Navicular Stand, Equine Cassette Holder

PLEXIGLAS X-RAY POSITIONER

MODEL BERLIN

- ideal for positioning
- V-shaped
- durable, transparent Plexiglas
- also as thoracic positioner for surgery

Set of all 5 sizes

703550

Size 1, W = 160mm, D = 90mm

703551

Size 2, W = 210mm, D = 150mm

703552

Size 3, W = 260mm, D = 160mm

703553

Size 4, W = 320mm, D = 200mm

703554

Size 5, W = 340mm, D = 230mm

703555

Wall mounting storage, stainless steel

703556



NAVICULAR STAND

Plastic, with Plexiglas foot rest

- outstanding evaluation of navicular bone is possible through a 60° oblique view
- with bracket for cassettes / plexiboxes

703540

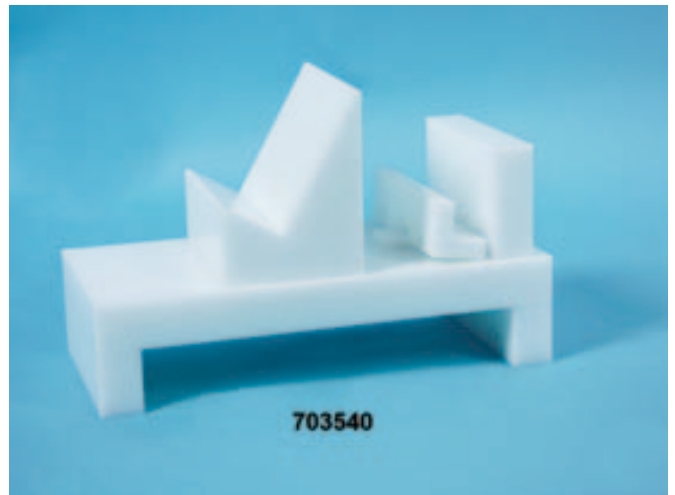

EQUINE X-RAY CASSETTE HOLDER

- adjustable for all cassette sizes
- stainless steel
- very durable

703800



Plexiglass Cassette Tunnel, X-Ray Accessories



PLEXIGLASS CASSETTE TUNNEL

With "L" + "R" -letter for X-Ray cassettes and grids 18×24cm, transparent
713118



EQUINE X-RAY HOOF TALLOW

To take shadow-free x-rays of the hoof
- 750g
703850



X-RAY MARKERS

- fast, convenient X-Ray marking

X-Ray Marker, L and R

704002

X-Ray Marker Clip, L and R

Slips on over the cassette frame, plastic

704022



X-RAY MEASURING CALLIPER

Aluminium calliper calibrated incm

- smoothly moving sliding portion

- for proper mA settings

704200

X-Ray Accessories, X-Ray Positioning Aids

X-RAY HD-RULER

For measurement of the NORBERG angle

704300

New generation of calliper for fast and easy measurement of the NORBERG angle, SASSNAU pattern

704500

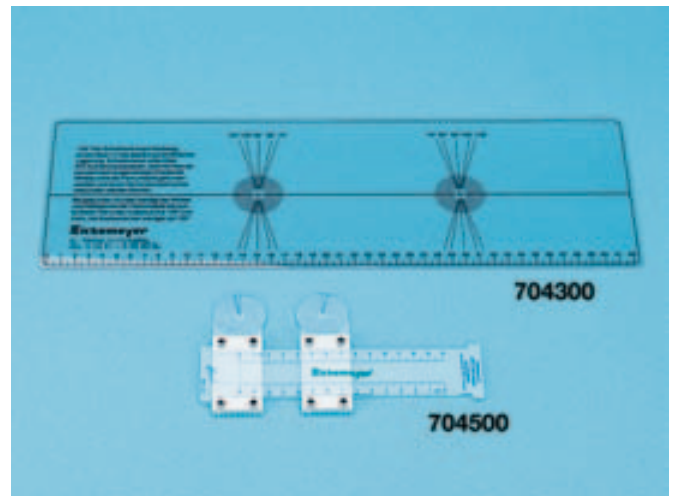

SAND BAGS

Proper immobilisation of the animal during X-Ray and surgery

- red, durable vinyl cover
- moulds easily
- easy to clean and to disinfect

Small, 15×25cm, 1.2kg

704515

Medium, 18×27cm, 2.0kg

704518

Large, 24×30cm, 3.5kg

704524



SAND BAG

Tube form, L = 75cm, D = 15cm, weight = 5kg

704550



X-Ray Positioning Aids, X-Ray Accessories

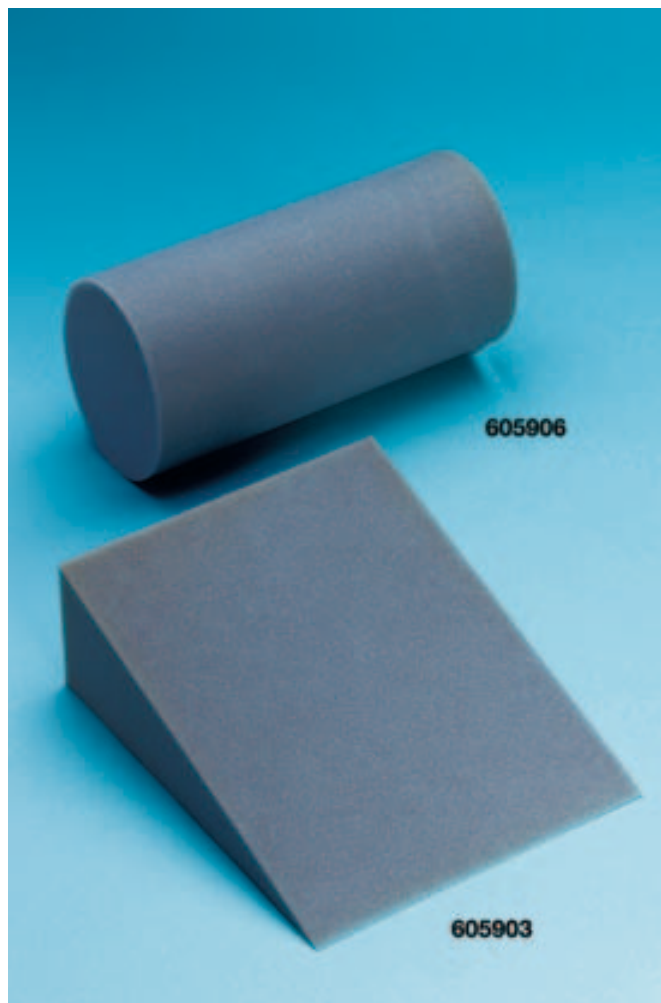

X-RAY POSITIONING AIDS

Proper positioning of the animal during X-Ray and surgery

- soft foamed plastic

Flat wedge, L = 26 × W = 20 × H = 7cm

605901

Small wedge, L = 11.5 × W = 20 × H = 6cm

605902

Large wedge, L = 25 × W = 20 × H = 11cm

605903

Rectangular pad, L = 25 × W = 20 × H = 7cm

605904

Circular pad with hole, OD = 20cm, ID = 7.5cm

605905

Roll, D = 11cm, H = 25cm

605906

Circular pad, D = 20cm, H = 5cm

605907



X-RAY PROTECTIVE APRON

- 0.5mm lead thickness

- lightweight

- water repellent and stain resistant nylon exterior, blue

- easy and quick on and off with Velcro strap closure

- protects perfectly

- comfortable and modern design

Length = 110cm, shoulder/hip-size = 41/60cm, height = 170–180cm, weight = 5.5kg

704935

Length = 120cm, shoulder/hip-size: 43/60cm, height = more than 180cm, weight = 6kg

704945

THYROID PROTECTION SHIELD

- 0.5mm lead protection
 - with Velcro closures
 - one size fits all
- 705001**



X-RAY HAND SHIELDS

- total touch control of small animals
- 0.5mm lead protection
- with Velcro closures

Small, width = 14cm, length = 20cm, pair
705501

Large, width 18cm, length 30cm, pair
705502

- X-Ray protective lead gloves, pair
 - with finger slits for complete finger/hand movement
 - ideal to restrain very small animals
 - one size fits all
- 705750**



X-RAY PROTECTIVE LEAD GLOVES

- flexible
 - comfortable to wear
 - 0.5mm lead protection
 - one size fits all
 - pair
- 705553**



X-RAY GAWN HANGER

- For two Aprons and one pair of Lead Gloves
 - rugged construction
 - rounded corner and edges protects aprons
- 705703**

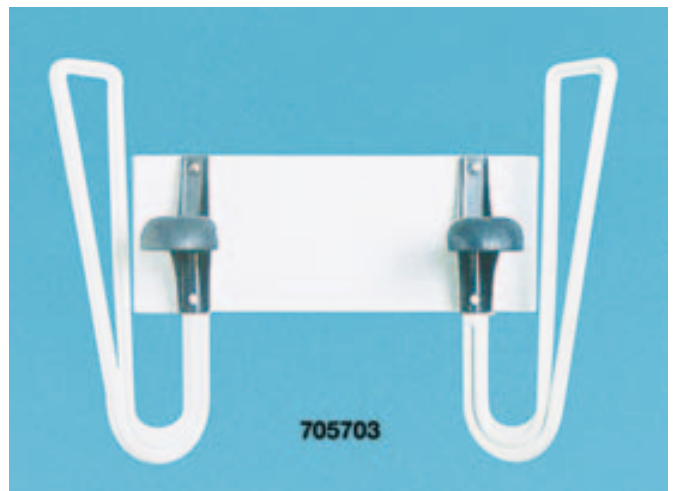

Dosimeter

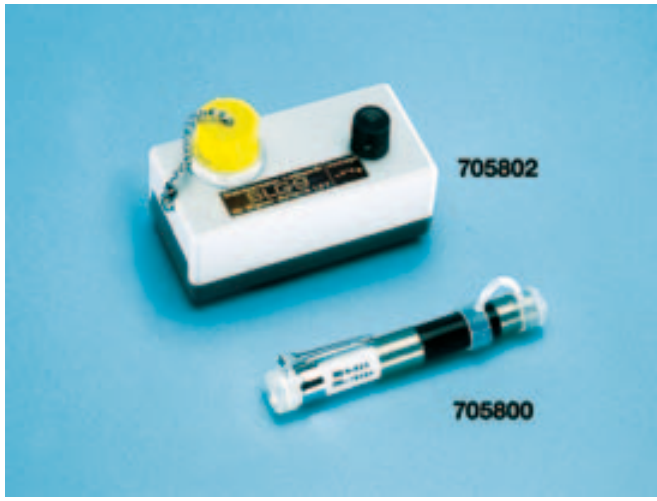

DOSIMETER

Dosimeter, energy range 40keV–3 MeV

0–2 mSv

- shows the personal radiation
- capable for gamma- and x-ray environment
- with a fixing clip
- with an ocular- and anti dust cover

705800

Gauging for dosimeter

(requested only in Germany)

705801

Charge and reset unit for dosimeter

705802

Digital dosimeter

Person-Dosimeter RAD 60 SE, energy range 60keV–3 MeV

705803



➔ **Eickemeyer Online**
– **www.eickemeyer.de**

Our website is dedicated to giving your clinic the services it demands:
Product information, stock availability, special offers and online ordering are just some of them.

You can access our online ordering service 24/7 – to log in all you need is your customer number and your postcode.



EICKEMEYER X-RAY PROCESSOR

All parameters of the EICKEMEYER x-ray film processor influencing image quality are factory set to optimal values. This makes the operation easier and reduces operator error

Just plug in the new processor and fill it with chemicals and the ECOMAX is ready for operation.

- perfect processing machine for the veterinary practice
- pre-sets assure easy handling and operation
- guarantees optimal image quality
- permanent chemicals recirculation
- regeneration adjusts automatically on the flow rate
- economical
- low maintenance level
- dimensions: L = 88 × W = 66 × H = 42cm

706100

Table for x-ray developing machine ECOMAX

706110

Transport system cleaner

706084

X-Ray Chemicals, Developing Hanger



DEVELOPING AND FIXING CHEMICALS

For X-Ray Processors

Developing Fluid, 2× 10 litre

706081

Fixing Fluid, 2× 10 litre

706082



CHEMICAL MIXING STICK

- Especially for mixing the “bath” for the X-ray developing unit
- X-ray chemicals work only with the perfect mixture

Red (fixing)

707500

Grey (developer)

707501



DEVELOPING AND FIXING CHEMICALS

For X-Ray Processors

- high quality concentrate
- easy to mix with water

Developing fluid, 5 litre concentrate, 25 litre outcome

707705

Fixing fluid, 5 litre concentrate, 25 litre outcome

707805



DEVELOPING HANGER

- fixes the X-Ray film w/o damage
- 4 special interlocking clips
- stainless steel

13×18cm

707913

18×24cm

707918

24×30cm

707924

30×40cm

707930

DEVELOPING HANGER PRO

- easy film developing
- just slide film into hanger

18×24cm

707818

24×30cm

707824

30×40cm

707830

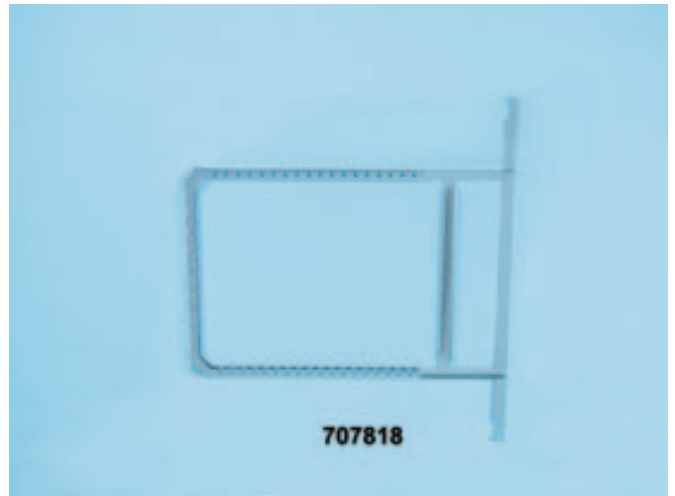

WALL MOUNT DEVELOPING HANGER

For 6 Developing Hangers, plastic

708006

With hook, 10mm

no illustration

708110

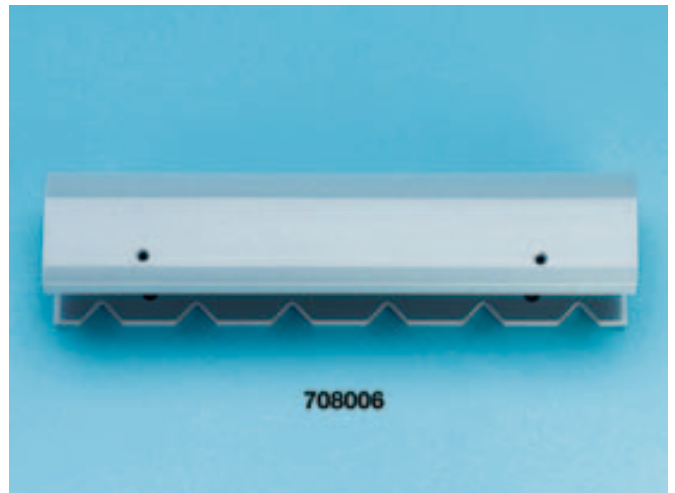

EICKEMEYER DARK ROOM LIGHT

For green and blue x-ray films

- large illumination field (16×21 cm)

- wall mount

708501

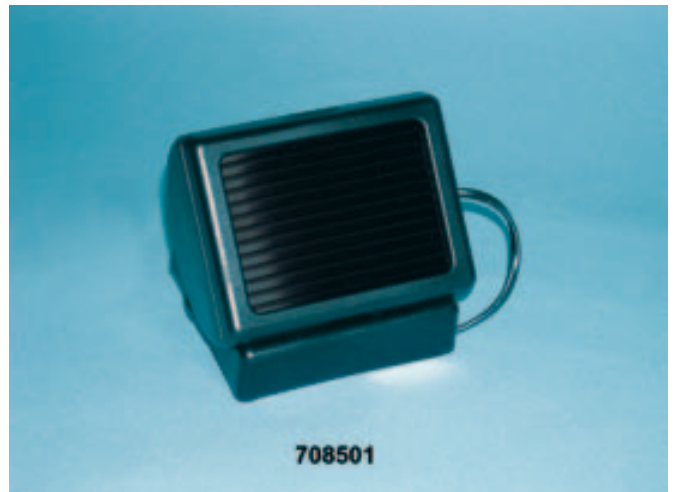

X-Ray Marking, Filmscribor



X-RITE X-RAY TAPE

- simple and fast inscribe with type writer or ball pen
- all important informations become a permanent image on X-ray film
- cost effective

X-ray identification tape, length = 7.6m
708825

Holder Blocker, pair, 1 green / 1 white
- 2 lines (24 figures per line)
- imprint your address on each radiograph
not illustrated
708900

X-Ray marking tape X-Rite with 2 Holder Blockers
not illustrated
708902

FILMSCRIBOR X-RAY FILM ID PRINTER

- X-ray film marking machine Filmscribor
- automatically controlled exposure line
 - easy marking of your radiographs
 - with exposure window 16.5×0.95cm
- 709000**

SCRIBOR-Stripes with text, not rubberised,
2000pcs/pkg.
- max. 3 lines with 30 figures per line
709008

Software to create your individual SCRIBOR-Stripes
- simple installation and easy handling
709015

Lead Tape for cassettes
709030

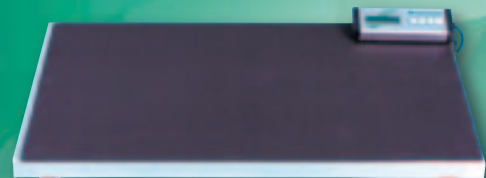

VET Eickemeyer®
Medizintechnik für Tierärzte





708070

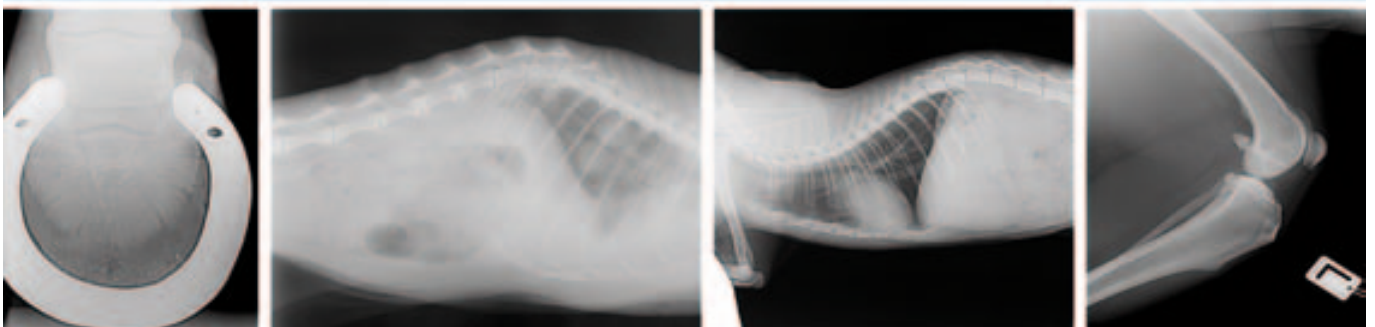

DIGITAL X-RAY SYSTEM PROSCAN

X-Ray developing – a thing for the past. PROSCAN is a modern, high resolution scanner for imaging plates (IP). It transfers X-ray information saved on the IP into a digital signal

Simple application:

- exposure of the IP (with existing unit and familiar settings)
- removal of the IP from the cassette
- placement of the IP on the PROSCAN, scanning starts automatically
- image data is automatically erased, IP can be used again right away
- data transferred to PC/Notebook for immediate diagnosis and image editing The image editing and managing software operates the CR-Scanner and routes the images automatically to a PACS-Software

Cleaning solution kit for imaging plates

708081

Direct Digital X-Ray DIGIVET



708200



DIRECT DIGITAL X-RAY DIGIVET

The DIGIVET combines excellent spacial resolution with an unmatched dynamic range, making it the perfect choice for all your critical radiographic imaging applications

- saves money: no developing, no chemicals
- saves time: after only 4 seconds you can see the X-Ray on the monitor
- improved diagnostic possibilities due to image editing (brightness, contrast, size, zoom, measuring etc.)
- comfortable: automatic archiving with image managing software
- modern: X-Ray can be discussed directly with the pet owner
- telemedicine: transmit your images via email
- compatible: fit all well-established X-Ray units

Standard delivery includes:

- powerful high end PC
- large diagnostic X-Ray monitor
- picture editing, managing and archiving software (PACS), DICOM 3.0 compliant

708200



708080

X-RAY FILM SCANNER RDC

The Radiograph Digital Converter (RDC) is an exciting innovation for veterinary radiology! This state of the art system allows you to capture high quality digital images of your X-Rays

- digitise X-Rays in less than 5 seconds
- capture high quality images of your X-Rays
- state of the art image editing software (brightness, contrast, size, zoom, measuring etc.)
- save your digitised X-Rays directly to your client file or send them by e-mail
- supports DICOM format
- easy USB connection
- for digital picture editing of X-Ray films up to 35×42cm

708080

Digital X-Ray



176600

DIGITAL DENTAL X-RAY SYSTEM EVA-VET

EV-Vet is a film-less, digital dental imaging radiology system that produces highest resolution, diagnostic quality images. Utilising patented "Active Column" CMOS technology, EVA produces high efficiency, low noise images which are digitalised and transmitted to your computer via a standard USB port and is compatible with laptop or desktop systems

EVA-VET with sensor No. 2 (3x4cm), USB connection and Software

- high resolution, diagnostic quality images
- easy to connect via USB
- convenient to use, state of the art software package (included)
- easy installation and operation
- supports DICOM format

176600

AFP X-Ray Book

no illustration

250001



176500

DIGITAL DENTAL X-RAX SYSTEM

precise dental photographs

- high capacity: 70kV, 8 mA
- small focal spot: 0.7mm
- TOSHIBA quality tube
- infinite adjustable exposition time from 0.08–3.2 seconds
- mobile stand model
- wall model on request

Wall mounted with 80cm overhang

176500

X-RAY FILM VIEWER PLANILUX

- High quality X-Ray film viewers for film reading
- 4 individually movable shutters for glare-free film reading
 - flicker-free, energy-saving high-frequency light (3 lamps)
 - variable electronic brightness control, control range approx. 90%

Viewing area: 400×430mm
 Housing: W = 600×H = 625×D = 105mm
709441

Viewing area: 800×430mm
 Housing: W = 1000 × H = 625 × D = 105mm
709481

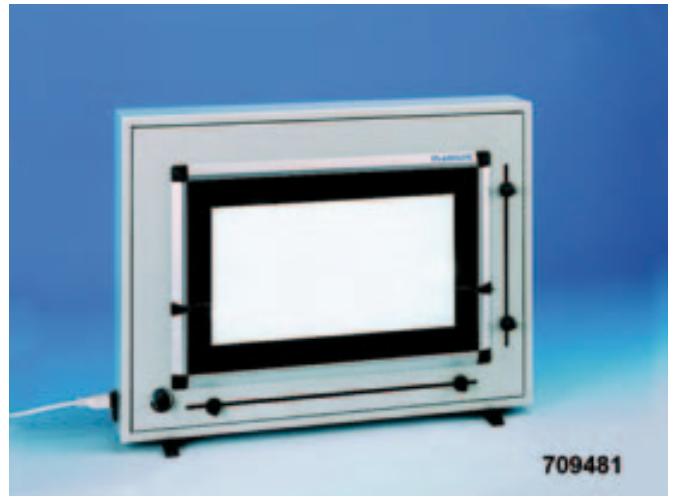

X-RAY FILM VIEWER SLIMLINE

- TFT-LCD Backlight Technology distributes the light evenly
- the uniformity of light distribution is more than 90% which guaranties an accurate film reading
- blue type light (CCFL-Technology) which is suitable for reading x-ray films
- economical, efficient and convenient
- long lamp lifetime

498 x 482 x 28 mm, viewing area:
 356 X 423 mm
709840

854 x 482 x 28 mm, viewing area:
 711 x 443 mm
709880



X-RAY FILM VIEWER EICKEMEYER

- film grip retainer
- table or wall mount
- bright light
- best price performance

Viewing area: 350×450mm
 Housing: W = 400 × H = 510 × D = 110mm
709571

Two viewing areas: 350×450mm each
 Housing: W = 800 × H = 510 × D = 110mm
709570



IRIS LAMP 100

- with flange and swivel arm, to fix to the wall or on the X-Ray Film Viewer
- indispensable accessory for the safe detection of small contrasts in the higher density ranges ($D > 2.2$) for a better evaluation of overexposed X-Rays
- extremely high luminous density of max. 70.000 cd/m².
- luminous density can be stepped down continuously to near extinction
- precision-type iris lamps smoothly adjust from 5–70mm and 5–100 diameter
- collimation of very small image areas with neatly contoured edges

709310



Microscopes



710060

MICROSCOPE EICKEMEYER

- binocular tubus
- wide field oculars WF 10x (18mm)
- Achromat objective 4x/0.1, 10x/0.25, 40x/0.65, 100x/1.25 oil
- Köhler illumination, halogen 6V/20W
- blue filter
- Abbe condensator 1.25 N.A.

710060



710002

MICROSCOPE MOTIC B1 VET

High quality combined with attractive pricing!

Microscope MOTIC B1 VET

Features:

- binocular head with wide field WF10x (18mm) eyepiece
- full range of achromatic (and semi-plan) objectives, PL4x/0.1, A10x/0.25, A40x/0.65, A100x/1.25, oil spring
- movable ABBE condensor N.A. 1.25, iris diaphragm for resolution and contrast control
- built-in ball bearing mechanical stage provides a travel range of 76mm x 50mm in the X and Y direction respectively with graduations read up to 0.1mm for accurate positioning of specimen
- standard halogen illumination (12V/20W)
- trinocular head available

710002

Heating table (warm stage) for MOTIC-Microscope

- 30 to 60°C, with digital display
- fixed with a knurled screw

not illustrated

710004

Phase Objective (plan) 40x/PH

not illustrated

710006

Phase Ring 40x

not illustrated

710007

Darkfield Lens for MOTIC Microscope

not illustrated

710008

MICROSCOPE MOTIC B3 VET

Top quality for a top price!

- Siedentopf binocular tube 30° inclined
- special 5-holes turret type condenser
- widefield eyepiece AWF10x (FN 20)
- plan objective: PL4x/0.10, PL10x/0.25, PL100x/1.25, oil spring
- phase contrast plan objective PL40xPH/0.65
- darkfield lens
- 1.25 ABBE condenser with rack and pinion focusing
- KOEHLER illumination, 12V/20W halogen
- standard blue, green, yellow and frosted filter for brightfield and phase application

710000

**DIGITAL MICROSCOPE MOTIC DMBA 200,**

with integrated, high resolution CCD camera, software, USB- and TV- connection

- simultaneous connection to PC or monitor possible
- possibility to send pictures via internet
- easy handling due to the "plug and play"
- software with extensive application
- binocular tubus, selectively 30° and 45° angle of view adjustable
- wide field oculars 10x (18)
- Plan Achromat objective 4x/0.1, 10x/0.25, 40x/0.65.100x/1
- cross table
- Abbe condenser with iris diaphragm
- halogen illumination 12V/20W, stageless adjustable

710005





MICROSCOPE ZEISS "PRIMO STAR"

- High end CARL ZEISS quality
 - 4x objective nosepiece
 - halogen illumination 6V/30W
 - cross table 75x30 cm
 - binocular tubus 30°/20
 - Plan-Achromat objectives A4x, A10x, A40x and A100x1.25 oil
 - height adjustable and possibility to center the condenser 0.9 / 1.25
 - Oculars 10x/19
 - easy handling
 - absolutely reliable
- 712060**



ACCESSORIES FOR MICROSCOPES

Cleaning Set for microscopes
not illustrated
710011

Immersion oil, 10ml, free of PCB
not illustrated
710010

Microscope slides, 26×75mm, 50/box
712026

Slide dispenser, for 50 microscope slides
712150

Cover slides 18×18mm, 1000/box
712518



STAINING RACK

Glass, 15×22cm
712715

SHAKER FOR BLOOD PIPETTES

Simultaneous and proportionate pipette mixing
713420



COUNTING PIECE

THOMA, separation in 400 squares with 0.05mm
- fast and easy counting of leukocytes and erythrocytes

713510

NEUBAUER, separated in 9 large squares
713520

TUERK
713540

Cover glasses for counting piece 0.4mm,
20×26mm, 10/box
not illustrated
713620



TEST TUBES / RACK

- with round bottom

Test Tubes with round bottom, 16mm×16cm,
100/box
714016

Test Tube Rack for 12 Tubes,
white epoxy-coated wire
714112



Centrifuges



718200

EICKEMEYER STANDARD CENTRIFUGE

For 6 × 15ml

- true running steel angle rotor
- infinite variable speed from 0–4500 rpm
- built-in timer, running time up to 60 minutes
- safe and easy to operate
- safety latch stops motor when lid is open
- best price performance

718200

Reduction Piece to 2ml

not illustrated

718322



718320

HETTICH EBA 20 TABLE-TOP CENTRIFUGE

Practical and handy, the EBA 20 is the ideal centrifuge for small sample volume.

- complete with an 8-place angle rotor
- microprocessor-controlled
- input of rotation speed in increments of 100, max. 6000 rpm
- ergonomically designed display elements
- built-in timer, running up to 99 min
- impulse key for very short centrifugal operations
- during centrifuging the actual values of the parameters are displayed
- variable: it accommodates various tubes as well as glass tubes w/o adapters

718320

HETTICH EBA 21 TABLE-TOP CENTRIFUGE

Maximum performance in microlitre centrifugation coupled with reliability in daily laboratory routine

- powerful, versatile and reliable
- maintenance free, stepless adjustable motor
- RCF of 23.907 at a speed of 18.000 rpm
- metal case, rotor-detection, cover-locking assures a high level of safety
- with timer
- multi-programming (3×)
- the rotor-detection limits the rotor to its maximum rotation speed
- precise and easy parameter entry via water resistant keypad
- w/o rotor

718321

Angel Rotor 45°, 12-part with cover

718326

Haematocrit Rotor with cover and evaluation disc

For 24 haematocrit-capillaries

718327

Angel Rotor 35°, 6-part with cover

718328



718321

HETTICH HAEMATOCRIT 210 CENTRIFUGE

HAEMATOCRIT 210 w/o rotor

- easy parameter entry via foil keypad
- during centrifuging the actual values of the parameters are displayed
- impulse key for very short centrifugal operations
- input of the rotation speed in increments of 100
- built-in-timer, running up to 99 min
- easy to read digital display
- fitted to latest safety requirements

718430

Haematocrit Rotor with cover and evaluation disc

24 haematocrit-capillars

718431



718430

MOBILE MINI HAEMATOCRIT CENTRIDUGE

EICKEMEYER Mini Haematocrit centrifuge

- for mobile use
- including rotor for 6 capillars
- fully automatic operation
- self-sealing mechanism
- silent
- small dimensions (L×W×H = 13×13×8cm)

718400



718400

Accessories for Centrifuges, Ampoules Rack



CAPILLARY TUBES

- capillary to take up blood and sealing material to close

Haematocrit Capillary Tubes 1.4×75mm,
1000/box

718375

Capillary Tube Sealant for Microhaematocrit
Tubes

714907

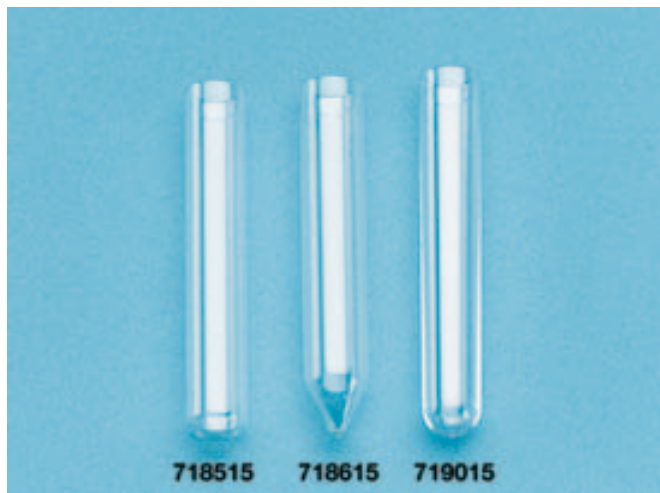

CENTRIFUGE TUBES

Glas Tube with circular bottom, 15ml
For plasma and serum

718515

Glas Tube with conical bottom, 15ml
For urine sediment

718615

Disposable Centrifuge Tubes, 15ml,
16×100mm, 100/box

719015

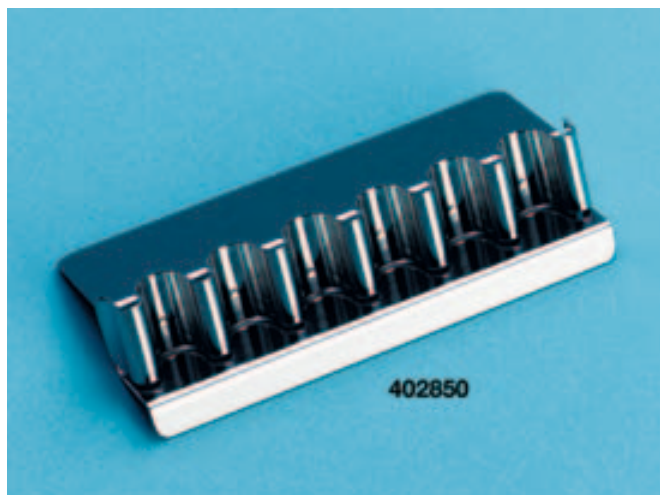

AMPOULE RACK

For 6 open ampoules

402850

CLINICAL REFRACTOMETER EICKEMEYER

For quick serum total protein concentration and accurate urinary specific gravity measurements
- a single drop is sufficient
- direct reading
- focusing eyepiece with eyecup
- simple calibration with distilled water
726000



KIDNEY BOWLS

Small, stainless steel, length = 17cm
728815

Large, stainless steel, length = 25cm
728825

Large, plastic, white, length = 25cm
728925



ELECTRONIC TIMER

Up to 60min, with signal
729510



Spray Bottle, Incubator



SPRAY BOTTLE

- transparent plastic
- flexible tip
- virtually unbreakable

250ml, plastic
729825

500ml, plastic
729850



FLOTATION EVALUATION IN FECAL SAMPLES

- to evaluate fecal samples
- to detect worm eggs
- pack with 50 pcs

50175

Flotation kit

050175

Flotation detection of worm eggs in fecal samples

not illustrated

50176

Flotation solution, 2 litres

050176



MELAG INCUBAT 80 INCUBATOR

- designed for all veterinary labs which require reliable and inexpensive methods of incubating cultures
- large capacity
- temperature range: 10°–60°C
- excellent temperature stability
- large glass door
- internal dimensions: W = 15cm, H = 30cm, D = 12cm
- external dimension: W = 27cm, H = 42cm, D = 14cm
- wall mounting

INCUBAT 80

732580

INCUBAT 80 ACCESSORIES

- Insert tray
732581
- Urine diagnosis rack for 9 micro slides
732582
- Rack for 30 test tubes
732583
- Rack for 6 Petri Dishes
732584

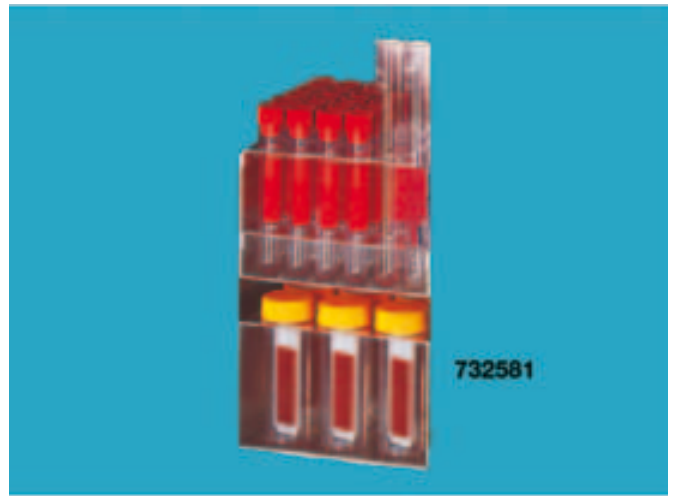

THERMOCULT INCUBATOR

- Approved and inexpensive Incubator
- temperature stability: 35 +/- 2°C (adjustable up to approx. 42°C)
- easy-to-read thermometer column
- 2 control lamps, mains and heating
- lightweight and handy
- OD: 30×17×17cm
- ID: 21×14.5×11 cm

- Thermocult Incubator
732590
- Insert tray
732591



BLOOD GAS ANALYSER I-STAT

The i-STAT is portable, easy to use, and performs a complete panel of tests from a single platform enabling you to quickly and effectively monitor and manage your patients

- fast and accurate
- precise and reliable with the most recent technology
- stores 50 test results
- no daily maintenance procedures
- only 65–100 microlitres of fresh whole blood sample
- automatic calibration
- equivalent to lab based systems
- optional printer available

- 733000**
- HP-printer
733010
- Printer paper for HP-printer I-STAT, pack of 3 rolls
733012
- Attachment for printer I-STAT
733011
- Software Update, 24hr replacement
- free software updates
- replacement in case of problems
- for 12 month
733017



Tests for Blood Gas Analyser, Forceps, Emasculators



TESTS FOR BLOOD GAS ANALYSER I-STAT

Self-contained i-STAT cartridges allow you to perform a number of critical care assays

- 25 test/box
- store between 6–8°C
- max. 3 months shelf life

Test G3+

For ph, PCO₂, PO₂, Bicarbonate, Total Carbon Dioxide, BE, O₂-Saturation

733003

WHELPING FORCEPS FOR DOGS

DANISH MODEL, 20cm

811720

NIEMAND, 28cm

811728



EMASCULATORS FOR HORSES

HAUSMANN, 30cm

850330



EMASCULATORS FOR HORSES

SERRA modified Emasculator, 35cm,
w/o ratchet
- for single hand use on a standing horse
not illustrated

851136

SAND, 31cm
- crushing only

850831



SPAY INSTRUMENTS FOR CATS

Spay Clip MORY
- clever spaying
- no assistance needed

851300

Spay Hook, D = 3mm, length = 16cm

851317

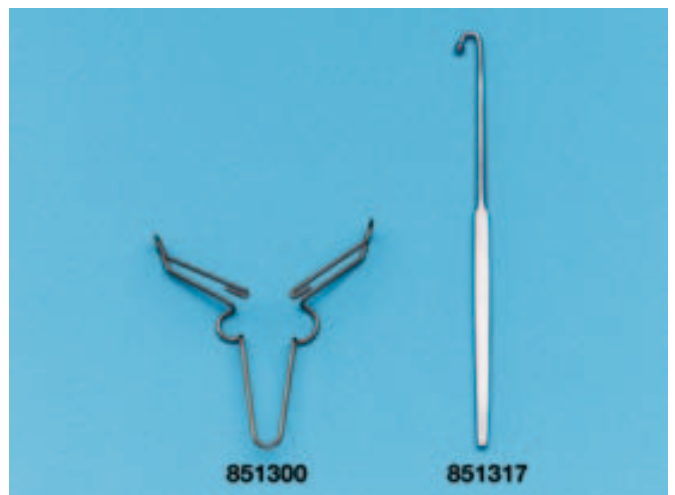

NEUTER INSTRUMENTS FOR TOM CATS

Nuter Clamp BOLBECHER, 16cm
- keeps hair away

851416

Nuter Sheet SENN, 10×10cm

851510

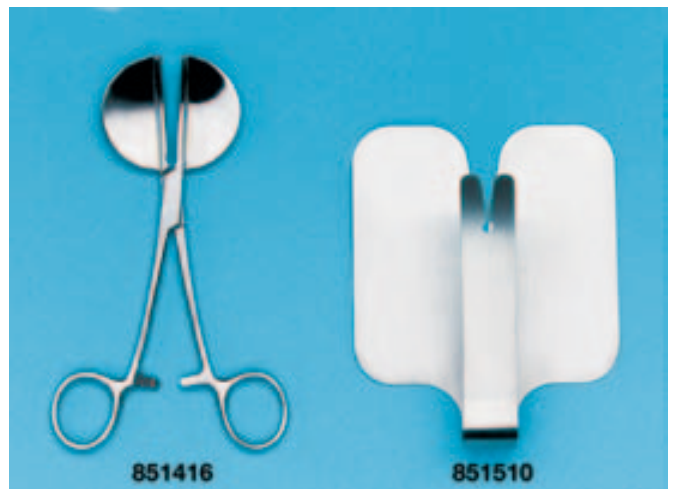

Hoof Knives, Hoof Instruments



HOOF KNIVES WITH WOODEN HANDLE

- high quality steel
- top price

Right hand, wide blade with small curl

860020

Left hand, wide blade with small curl

860120

Double edge, with small curl

860220



HOOF KNIVES WITH EBONY HANDLE

- top quality
- extremely durable steel
- excellent cutting edge that remains sharp even during prolonged periods of use

Right hand, narrow blade with small curl

860619

Left hand, narrow blade with small curl

860719

Hoof knife sharpening stone

- to sharpen hoof knives also inside the curl

861700



HOOF TESTERS

Light model, 30cm, stainless steel

862030

Heavy-duty model, 34cm, stainless steel

862034

VIENNA model, 36cm, stainless steel

862036

BOENING-HERTSCH, 44.5cm, stainless steel

- variable adjustable with strong grip for more even diagnostic pressure

- one hand control

- asymmetric mouth

862040

APPENDIX TROCAR FOR HORSES

Equine trocar, 15.5cm, D = 2.8mm,
871203



VISITS CASE

Blue, W = 47 × H = 35 × D = 18cm, with 8 trays
- easy drug storage
- one-hand opening
- lightweight
- durable plastic
- also available in grey
910910



VISITS CASE VET-CASE

W = 360 × H = 240 × D = 215mm
- rugged, sturdy case, weight = 3.8kg
- compact storage of instruments and medicine
- ready for immediate use
- easy to clean
910950



FOREIGN BODY FORCEPS

HARTMANN, 8cm
872008

HARTMANN, 14cm
872014

HARTMANN, 16cm
872016



Forceps, Electric Tattoo Kit, Tattoo Forceps

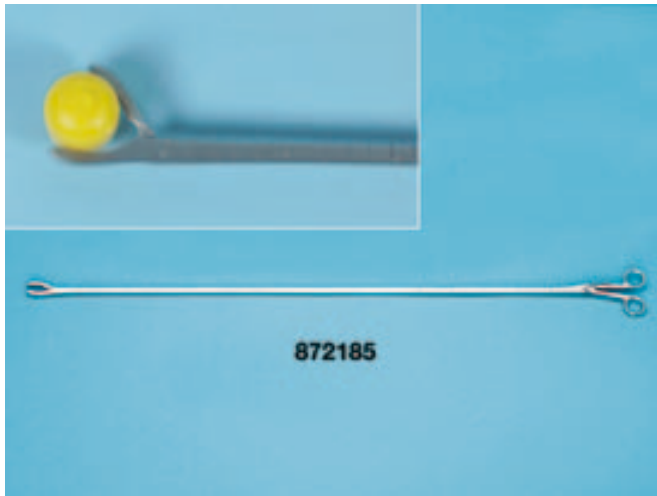

FOREIGN BODY FORCEPS

- specially designed for grasping large foreign bodies in dogs

Rigid, long model, 85cm
872185



ELECTRIC TATTOO KIT

The whispering tattoo needle

- gentle
- easy to clean
- silent operation
- for accurate tattooing on small animals

Electronic Tattooing Kit

900000

Spare needle

900005



TATTOO FORCEPS

- heavy-duty construction
- marker jaws holds 7 letters or digits
- easy and professional tattooing
- letter/digit-height = 5mm

Tattoo Forceps

900050

Set of letters A-Z in wooden case

900055

Single spare Letters

900060

2 sets of digits 0–9, wooden case, with Forceps and 6 spacing plates

900065

Single Spare Digits

900070

Set of digits 0–9, w/o spacing plates

900075

TATTOO INK

- easy handling
- excellent for permanent tattoos

Black, fluid, 100ml

900020

Green, fluid, 100ml

900025

Black, tube with 60g

902014

Green, tube with 60g

902015

AESCULAP FAVORITA II CLIPPER

German engineering at it's best!

The FAVORITA offers smooth, silent operation with precise cutting. The clipper that meets all your clinical needs

- powerful
- light weight
- large range of clipper blades
- easy maintenance
- reliable
- push button blade release
- quiet operation
- very durable

902102



Clipper Blades, Blade Sharpening

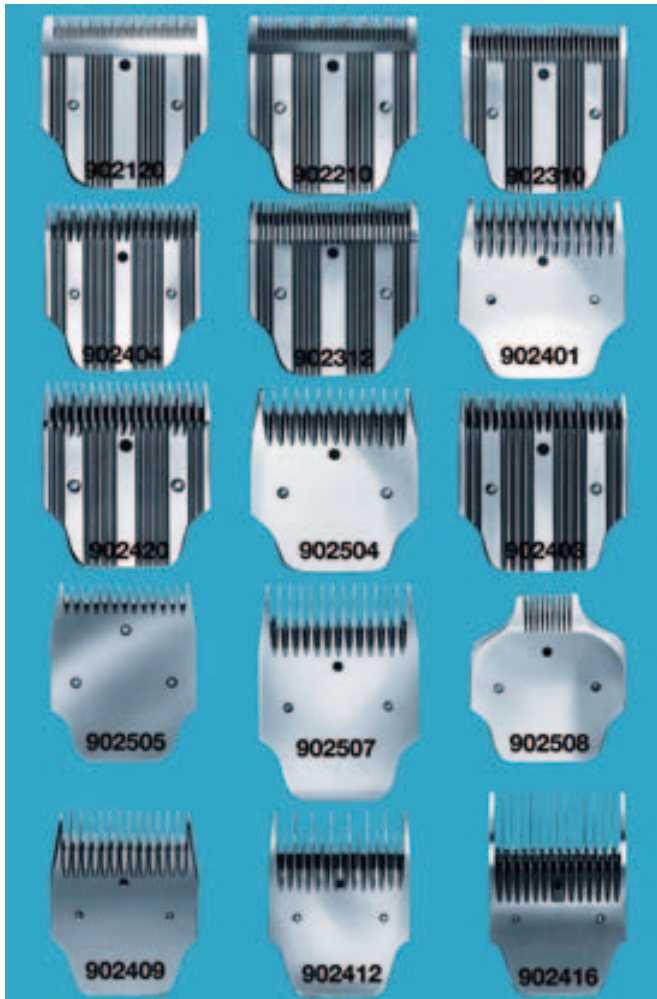

CLIPPER BLADES FOR FAVORITA II

- fast cutting
- specially hardened steel
- easily detachable
- long life

1/20mm (surgical shave)

902120

1/10mm (surgical shave, cats)

902210

1/2mm (all-round blade)

902312

1mm, fine

902404

1mm, coarse

902401

3mm (for matted hair, Angora)

902503

2mm

902402

2mm, long teeth

902420

3mm

902403

3mm, coarse

902504

5mm

902505

7mm

902507

9mm

902409

12mm

902412

16mm

902416

Especially for paws

902508

VET Eickemeyer®

Our service – Your benefit

We sharpen your clipper blades.
Within 5–7 days our skilled craftsmen
will service and sharpen your clipper
blades

ACCESSORIES FOR FAVORITA II

Cable roller, wall and ceiling mountable, 3m

- cable always ready at hand

902509

Wall Mount for clipper

- safe and practical storage

902510

Rack for clipper blades

- for optimal storage of clipper blades

902511

Vacuum device

- for a clean working field

- fits on almost every vacuum cleaner

902512

Special oil for clipper blades

- lubrication after cleaning

902514



CLIPPER SPRAY

400ml

- cleans blade while clipping

- lubricates

- disinfects

- cools

- extends the working life of your blades

902513



CLIPPER PANASONIC

Ideal for small areas

- battery powered

- including clipper head

- variable cutting length

- small and silent

- modern design

903068

Clipper blade for 903068

903069



Clipper Blades, Clippers

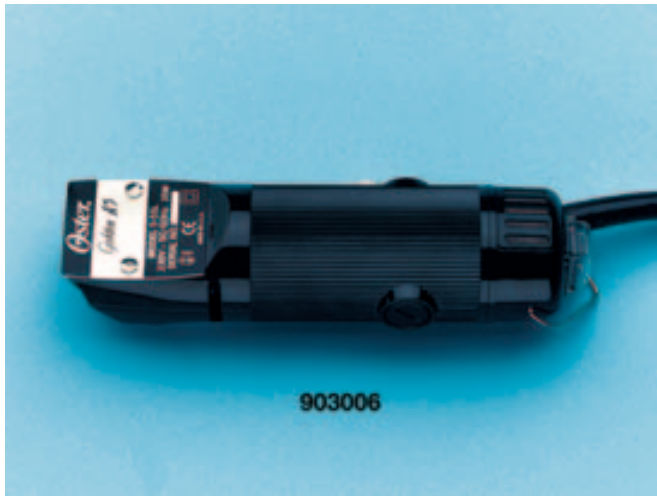

OSTER GOLDEN A5 CLIPPER

- reliable
- quiet
- easily detachable clipper blades
- attractive price

OSTER A5 Clipper 1-Speed w/o blade
903006

OSTER A5 Clipper 2-Speed w/o blade
- normal speed for precise clipping
- high-speed (30% more speed) for faster body clipping
903007

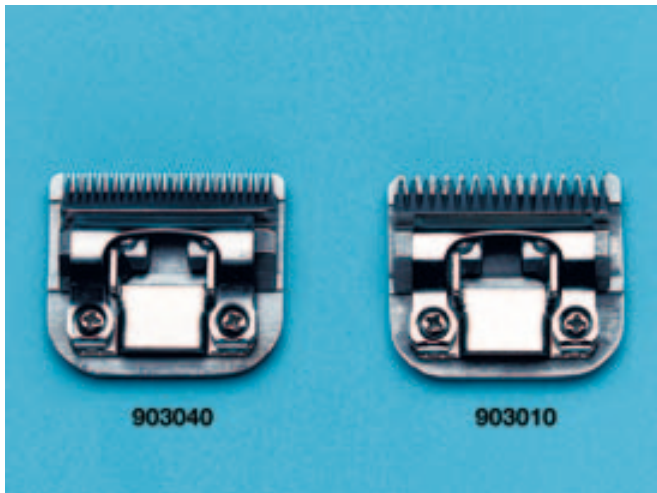

OSTER BLADES

Size 40, 1/10mm

903040

Size 10 / 1.6mm

903010

Size 7/8, especially for paws, width = 10mm

903041

Size 15 / 0.5mm

903015

Size 8.5 / 2mm

903016

Size 7 / 3mm

903017

Size 5 / 6mm

903018

Clipper blade No. 5 (7mm)

903019

Size 4 / 9mm

903020

Size 5/8, especially for Paws

903022

Clipper blade 7/8" (7mm)

903023

Size 50 / 1/20mm

903025



THRIVE 8000 AD CLIPPER

With two clipper blades (1mm and 1/10mm)

- high capacity rechargeable battery
- long working time
- fast recharging
- powerful
- quiet

903050

TICK REMOVING FORCEPS

- fast and safe removal of ticks
- easy to sell in your practice
- lightweight and robust

FARK pattern, 12cm

- easy to use
- complete removal of the intact tick
- autoclavable

907212

Aluminium, 16cm

907216

Plastic, 7cm

907320



NAIL CLIPPERS

CATCLAW Clipper, 12cm

908007

MILLER, 13cm, with spacer

- spacer protects from injury

908113

GUILLOTINE CLIPPER, 12cm, for cats and small dogs

908212

Nail Clipper with spring, 13cm, for dogs

908213



NAIL CLIPPERS

Heavy duty Nail Clipper, 16cm, stainless steel blades, plastic handles

908216



CANINE SKELETON

Natural bones

- informative
- decorative in your practice
- mounted on a black wooden base
- perfect client education tool
- ideal to study anatomy before or during orthopaedic surgery

909000



Canine Skeleton, Feline Skeleton, Horse Foot



FELINE SKELETON

- Natural bones
- informative
 - decorative in your practice
 - mounted on a black wooden base
 - perfect client education tool
 - ideal to study anatomy before or during orthopaedic surgery

909005



ARTIFICIAL DOG SKELETON

- Detailed copy, made of plastic,
L = 60cm, H = 30cm

909008



ARTIFICIAL CAT SKELETON

- Detailed Copy, made of plastic, L = 60cm,
H = 30cm

909009



HORSE FOOT

- Natural bones
- informative
 - decorative
 - mounted on a wooden base

909010

LONG SAGITTAL SEC. (FRONTLIMB)

Exceptional value and quality represented in this instructional specimen. Meticulously prepared and preserved. The internal structures of the hoof, limb and knee are undistorted and easily identifiable. Whether teaching or talking to clients in the field, the veterinarian will appreciate the detail of this sagittal selection.
178385



ULTRA LIMB

An invaluable tool for teaching or a handy reference for ultra-sound study. Equine lower limb is cross-sectioned from the Coronary Band to the proximal end of the Cannon Bone. The hoof is divided sagittally and hinged. Everything is connected with a tough flexible strap.
178380



CANINE STIFLE

Shows
- patella
- meniscus
- cross bars
909033



SPINAL COLUMN

- Shows intervertebral discs and normal vertebrae
909035



Osteo Models, Ear Model (Dog), Small Animal Scales



ELBOW

- avulsed anconeal process (painted red)
 - fractured coronoid process (painted red)
 - osteochondritis dissecans (painted red)
 - articulated with elastic cord
 - demonstrates: flexion, extension and rotation
- 909036**



HIP-MODEL

- right cox of femoral joint – normal
 - left cox of femoral joint – arthritis/hip dysplasia
 - lumbar sacral (L/S) joint – ventral spondylosis
 - intervertebral disc (L6/L7) – normal
 - intervertebral disc (L/S joint) – dorso-laterally herniated
 - yellow flexible spinal cord and nerves
 - all joints fully articulated with elastic cord
 - demonstrates: full range of motion for hip joints, lumbar sacral joint and vertebra
- 909034**



EAR MODEL (DOG)

- cutaway shows canine ear canal, tympanic membrane
 - ear canal shows wax, inflammation, infection, tox tail and polyp
- 173935**



SMALL ANIMAL SCALES

- Up to 20kg
- large, easy-to-read LCD-Display
 - easy to handle with one key
 - push button zero/tare-function
 - battery operated and auto-off automatic
- 909050**

WALK-ON PLATFORM SCALE SLIM-LINE

- flat walk-on scale, extremely space-saving
- large easy-to-read LCD-display with wall mounting
- HOLD button (precise weight even if the animal shakes)
- 0–150kg scale (100g steps)
- dimensions: 90×55×4.5cm
- stainless steel cover
- battery or mains operated
- including anti-slip mat, grey
- best price performance

909100

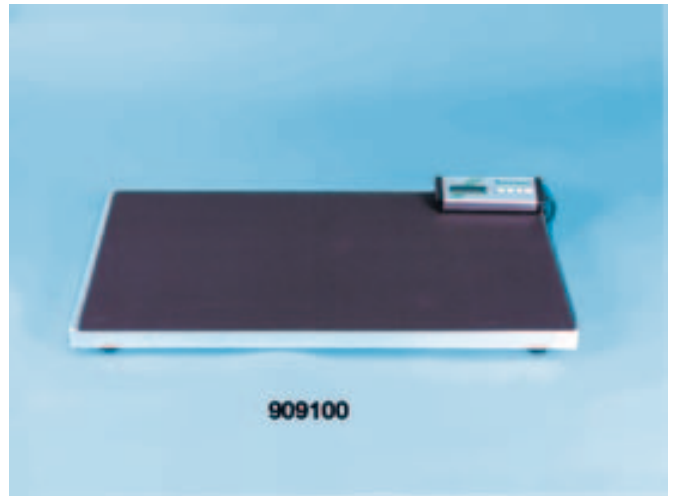

MOBILITY CARTS FOR DOGS

- ideal help for paralysed dogs
- easy to apply
- easy to handle – no special training required

1.5–5kg, Badger-dog

909500

1.5–2.5kg, Poodles

909502

2.7–5.5kg, Poodles

909503

5–11.5kg, Badger-dogs & Cocker

909501

5.5–9kg, Poodles and Cats

909504

9–12kg, Beagles and mixtures

909505

12–18kg, Beagles and mixtures

909506

18–27kg, Shepherds and mixtures

909507

27–34kg, Shepherds

909508

45kg and more, Shepherds and Rottweiler

909509



DISPOSABLE PLASTIC SURGERY DRAPE

- ideal to cover the complete surgery table
- wall mounting bracket

Length: 200m, width = 120cm, double folded, strength = 0.025mm

920060

Wall mounting bracket for plastic surgery drape

920061

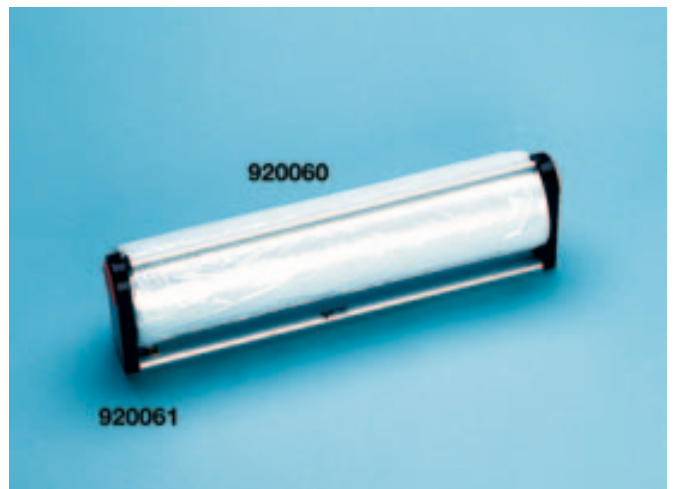

Surgery Drapes, Adhesive Spray

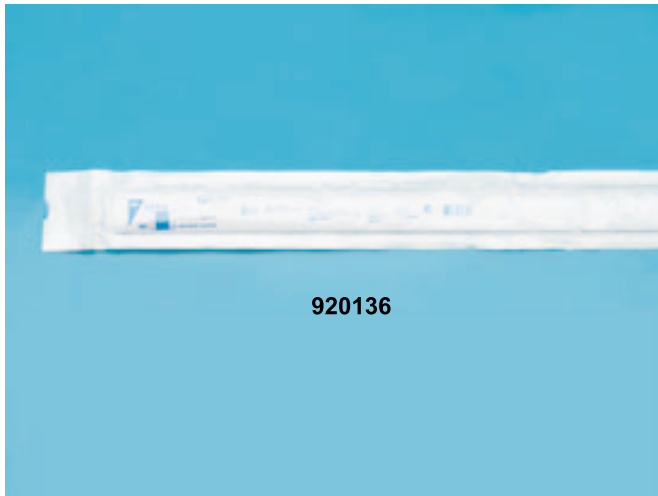

ADHESIVE DRAPES

- self adhesive
- sterile wound cover

86×91cm, single
920136



DISPOSABLE SURGERY DRAPES, BLUE

- soft and strong PVC, individually packed (sterile)
- adhesive spray for application, 25/box

30×45cm
920145
60×90cm
920190
90×120cm
920212
120×120cm
921212
120×180cm
921218
120×250cm
921225



DISPOSABLE SURGERY DRAPES WITH ABSORBANT COATING

- PE-coated drape
- individually packed, steril
- 25 pcs per pack

35 x50 cm
921500
50 x50 cm
921501
50 x75 cm
921502
75 x90 cm
921503
150 x200 cm
921504



ADHESIVE SPRAY

240ml, spray bottle
For rapid fixation of disposable drapes
952600

CLOTH SURGICAL DRAPE

- green, high absorbent and durable cotton (surgical-grade)
- washable
- autoclavable

40×60cm

921260

70×70cm

921270

90×90cm

921290

Surgical drape, width 160cm,

- green, high absorbent and durable cotton
- sold by the meter

921400

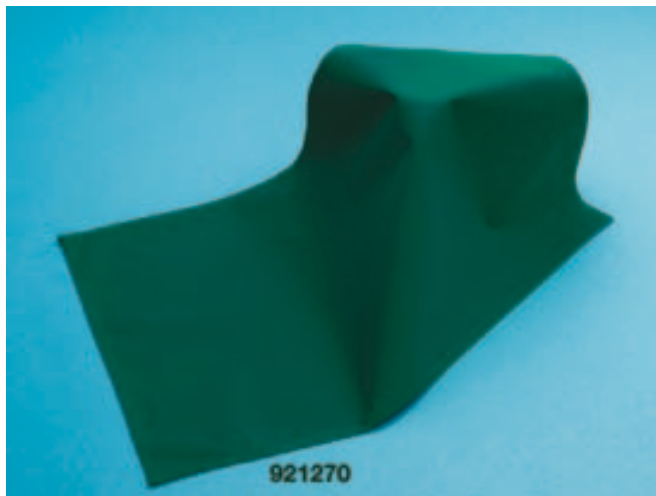

CLOTH SURGERY DRAPE

- fenestrated

40×60cm, opening length = 15cm

921360

70×70cm, opening length = 20cm

921370

90×90cm, opening length = 35cm

921390

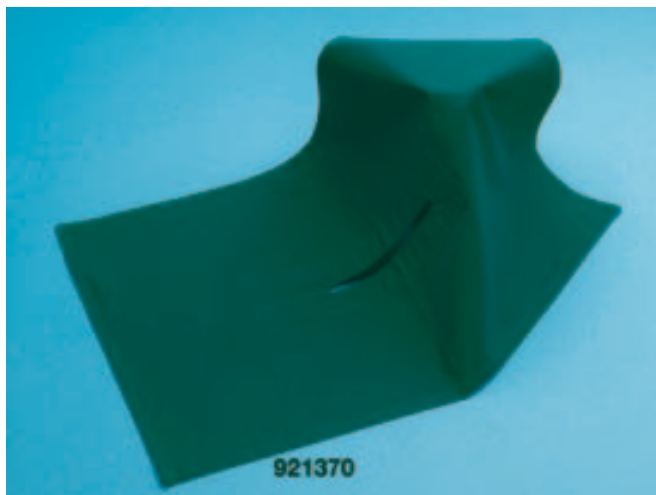

CLOTH SURGERY DRAPE FOR NUTERING

- 51×40cm, fenestrated
- cut length = 24cm
- 100% cotton
- washable

851520



SURGERY GLOVES SEMPERMED

Sterile surgical glove, lightly powdered

- surgical glove with a high resistance to tearing and a reliable impermeability
- Natural rubber latex, hypoallergenic
- micro-rough surface – excellent sensitivity
- each pair packed sterile, 50 pairs/box

Size 6

930760

Size 6 1/2

930765

Size 7

930770

Size 7 1/2

930775

Size 8

930780

Size 8 1/2

930785



Disposable Aprons, Disposable Gowns, Surgeons Clothing



DISPOSABLE APRONS

- Disposable aprons, 150/box
 - white durable plastic
 - in dispenser box
- 940320**



DISPOSABLE OPERATING GOWNS

- Isolation gown, universal size
 - knit fabric wrist cuffs
- 940740**
 - Isolation gown, light model, universal size, white
 - with buttons

940752
 - Disposable gown, sterile, plastic, universal size

940275



SURGEONS CLOTHING ,KASACK'

- 100% cotton
- comfortable to wear
- green

Size 1, small

940601

Size 2, medium

940602

Size 3, large

940603

Size 4, x-large

940604

OPERATING GOWNS

- HANNOVER model, 100% cotton
- green
- centre tie back belt
- extra wide raglan sleeves

Size 0, x-small

940700

Size 1, small

940701

Size 2, medium

940702

Size 3, large

940703

Size 4, x-large

940704



SURGEONS CAPS

Universal size, 100% cotton, green with rear ties

940760



Abdominal Bandage

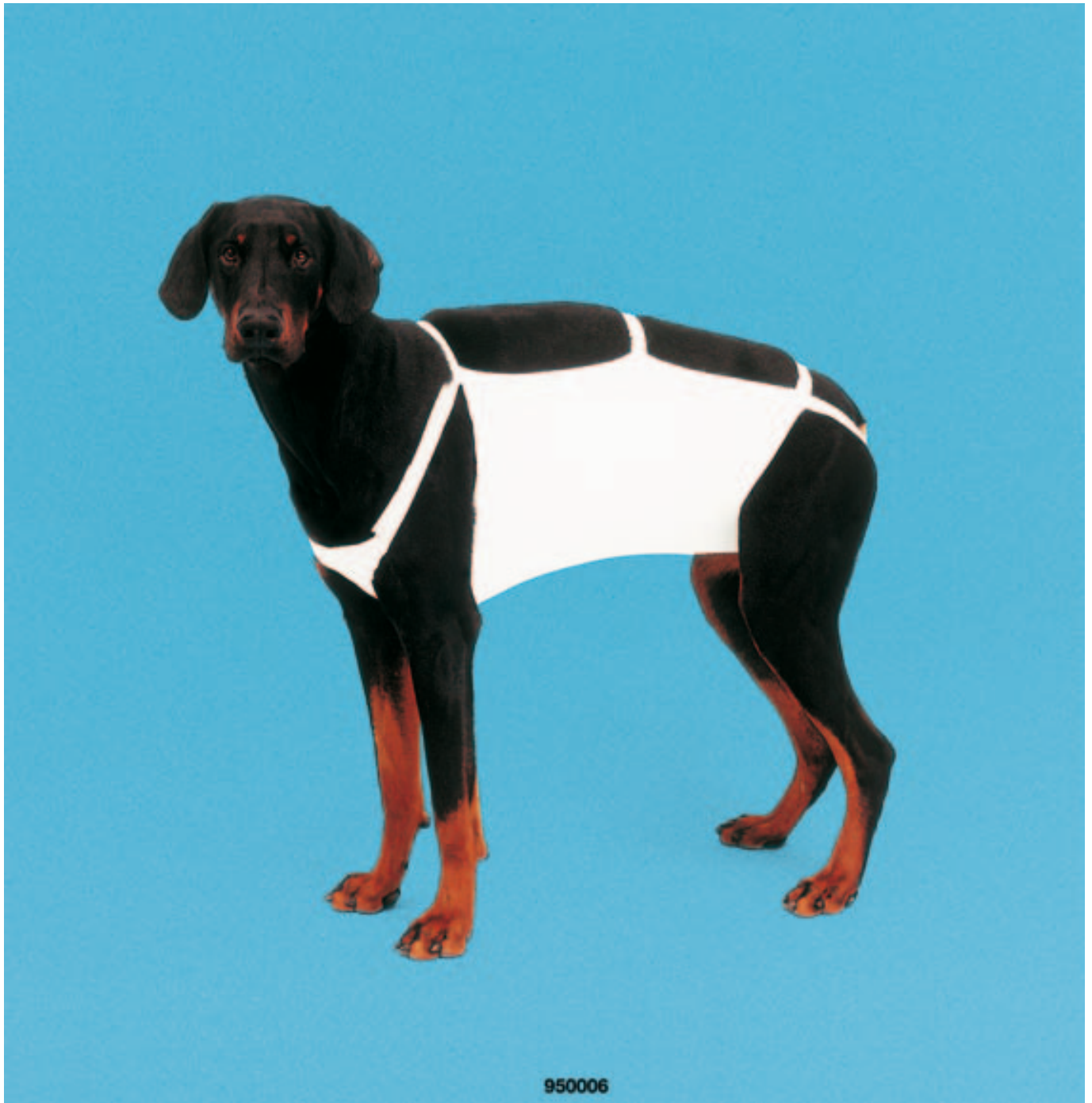

ABDOMINAL BANDAGE LAUSCHNER

Especially designed for the comfort of your patients. The abdominal bandage covers and protects wounds in the abdominal area and offers an excellent healing environment

- comfortable to wear
- 100% cotton
- washable up to 95°C
- adjustable Velcro closures for a perfect fit
- 7 different sizes available

Size 1, Cats, length: 32cm

950001

Size 2, Poodles, length: 38cm

950002

Size 3, Cockers, Setters, length: 47cm

950003

Size 4, small German Shepherds, length: 51cm

950004

Size 5, St. Bernard's, big German Shepherds, length: 60cm

950005

Size 6, Great Dane, length: 67cm

950006

Size 7, big St. Bernhard, Great Danes, length: 67cm

950007

Nylon Muzzles, Padded Plastic Splints, Hoof Bandage, Pet Pill Gun

EICKEMEYER NYLON MUZZLE

- highest quality nylon
- easy to wear, with quick release snap
- washable

Size 0
951200
Size 1
951201
Size 2
951202
Size 3
951203
Size 4
951204
Size 5
951205

PADDED PLASTIC SPLINTS

Providing excellent support for distal limb injuries.

- easy to cut
- strong, lightweight plastic
- with non-irritating foam padding
- fully radiolucent

20×3cm
951720
30×4cm
951730
40×5cm
951740

HOOF BANDAGE, RIEGER PATTERN

- minimum one week bandage application
- safe, time-easy application with Velcro closure
- saves money, can be used for about 6 weeks

Size 3, for Arabian horses
951703
Size 4, medium for warmblood horses
951704
Size 5, large for warmblood horses
951705

PET PILL GUN

- For cats and dogs
- easy way of administering tablets
 - water is added to facilitate swallowing
 - 10/box
- 951802**

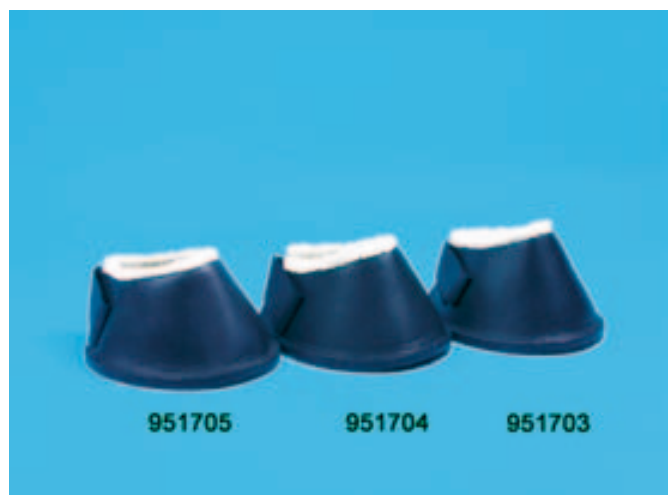
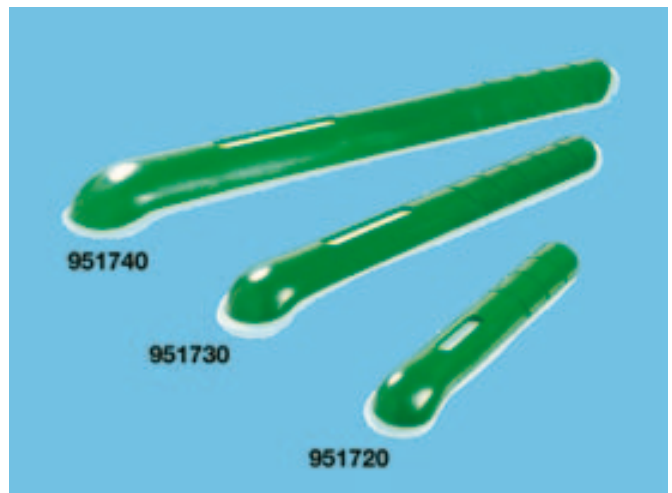

Post Mortem Bags



POST MORTEM BAGS

110×75×100cm, 20/box
- heavy-duty black plastic
951825

	Page		Page
A			
Abdominal Bandage	312	Cats Cradle.....	258
Accessories for Centrifuges.....	290	Cat Surgery Table.....	235
Accessories for Clippers.....	301	Cat Trap.....	124
Accessories for ELAN-VET-LINE and MINILAN.....	120	CCD-Cameras	168-169
Accessories for HEINE OMEGA 500.....	28	CCL Staple Instrument	86
Accessories for Radiosurgery.....	199	Ceiling Mount Ring	247
Accessories for Tracheal Tubes	142	Cellulose Spears	42
Acetabular Plates	100	Central Gas Supplying System.....	130
Adaptors	54, 167	Centrifuge	288-289
Adhesive Spray	308	Cerclage Wire Forceps.....	84
Alcohol- and Cotton Dispenser.....	227	Cerclage Wire Passer.....	85
Ampoules Rack	290	Cheek Dilators	55
Anaesthesia Machine	126-128, 133	Chucks.....	80-81
Anaesthesia Masks	142-143	Clamps	15, 73, 79
Anaesthesia Monitoring.....	152	Cleaning and Maintenance.....	47
Anaesthetic Accessories.....	135, 144	Clipper	299, 301-302
Anaesthetic Machines for Large Animals	131-133	Clipper Blades	300, 302
Anaesthetic Machines for Small Animals.....	125, 128	Clips.....	12
Anaesthetic Set	144	CO ₂ -Insufflator	166
Anaesthetic System NarkoPet.....	145	CO ₂ Laser.....	194
Anal Sac Cannulas.....	206	Collars	156
Anatomical Models	305	Combined Monitors	148-150
Animal Stretcher.....	240	Compression Plates	95-98
Apple Core Tooth Rasp	67	Compressor.....	44
Aprons.....	272	Connectors	138, 140
Artery Clips.....	12	Containers for Sterilisation	81-82, 219-220
Arthroscopy Instruments.....	162-164	Counting Piece	287
Aspheric Lenses.....	28	Covers for Camera	175
Aspiration Biopsy.....	204	Cranial Crucial Ligament System	87
Aspiration System.....	183	Cryo Surgery	42
Autoclaves.....	214-215, 218	Curettes.....	25-26
B			
Bandage Scissors.....	9	Curved Bulb Holder.....	141
Battery Handles.....	157-158	Cuttable Plates	99
BAYHA Scalpel Handle.....	3	Cutting Disc.....	46
Binocular Loupes.....	34	D	
Biopsy Needles.....	204-205	Dental Care Unit.....	43
Bipolar Forceps	197	Dental Elevators	49
Bird Collars.....	157	Dental Forceps	50
Bird Ring Cutter.....	10	Dental Halter.....	65
Blades.....	121	Dental Hand Instruments.....	50-51
Blood Gas Analyser.....	293	Dental Instruments for Horses.....	61-62
Blowtube Systems.....	154-155	Dental Micromotor	45
Bone Biopsy	93	Dental Models.....	49
Bone Cement.....	116	Dental Root Set	48
Bone Holding Forceps.....	91	Dental Scalers	51-54
Bone Laminectomy Forceps.....	92	Dental Tray	54
Bone Plate Benders.....	104	Depilation Forceps.....	37
Bone Plates	95-99, 102-103	Depilatory Needles	196
Bone Rasps	88	Depth Gauges	104
Bone Retractors.....	90	Dermatoscopes	73
Bone Rongeurs.....	92	Developing Fluid.....	276
Bone Saws	89	Developing Hanger.....	276-277
Bone Scoops	25-26	Diagnostic Lamp.....	141
Broad Compression Plates.....	98-99	Diagnostic Instruments.....	158-160
Broad Extension Plates	99	Diamond Cutting Disc.....	68
Brush Dispenser.....	227	Digital X-Ray.....	279-280, 282
Buckets.....	233	Display Rack for Endotracheal Tubes	139
Bulb Syringes	72	Disposable Aprons.....	310
Bur Guard.....	46	Disposable Culture Swabs	210
Bur Kits	45-46	Disposable Drape	307
C			
Canine and Feline Mouth Gags.....	57, 122	Disposable Gowns.....	310
Canine Skeleton	303-304	Dissecting Scissors	7
Cannulas	206	Distillator.....	217
Capnometer.....	148	Dog Catheters	208
Carbide Burs.....	68	Doppler.....	154
Cart for Ultrasound Machine.....	188	Drainage System	210
Cat Catcher	123	Drapes	307, 309
Cat Catheters	208	Dressing Scissors.....	5-6
Catching Net.....	122	Drill Guide.....	105, 113
Catheters.....	207-209, 212-213	Drill Insert Sleeves.....	113
		Dry Heat Sterilisers.....	221, 222
		E	
		Ear Cleaning Instruments.....	71

Index

	Page		Page
Ear Forceps	71	Handles	105
Ear Irrigation	72	Headlamp	35-36
Ear Model (Dog)	306	Heating Pads	239, 259
Ear Specula	158	Heat Sealing Unit	220
ECG-Paper	193	Heimlich Valve	211
ECG Accessories	193	High Frequency X-Ray Machines	265
Eickfil Suture	18	Hoof Bandage	313
ELAN-VET-LINE	119	Hoof Instruments	296
Electric Cautery	199-200	Hoof Knives	296
Electric Equine Tooth Rasps	65-66	Hoof Tallow	270
Electric Tattoo Kit	298	Horse Foot	304
Electrosurgery Set	118	Hydraulic Surgery Tables	231, 234
Electrosurgery Unit	195, 198	Hypomochlion	69
Electrodes	196	I	
Electronic Timer	291	Image Capture System	170
Emasculators	294-295	Implant Cutters	82
Endoscope Adapters	169	Incubator	292-293
Endoscope Cart	176-177	Indicator Tape	221-222
Endoscope Cleaning	177	Inflatable Support	242
Endoscopes	161	Inflow Cannula	165
Endoscope Sheaths	161-162	Infusion Kit for Horses	201
Endotracheal Tubes	136-137, 139	Infusion Pump	202
Endotracheal Tubes for Horses	140	Inhalation Mask	155
Enterotomy Scissors	8	Inhalation System for Horses	155
Equine Anaesthesia	131-133	Instrument Boxes	219
Equine Cassette Holder	269	Instrument Brush	226
Equine Catheters	209	Instrument Cabinet	248
Equine Dental Equipment	58-62	Instrument Cleaning Agents	225
Equine Dental Forceps	58	Instrument Containers	223
Equine Head Protection	242	Instrument Marking Tape	221
Equine Mouth Gags	140	Instrument Oil	225
Equine Mouth Speculum	69-70	Instrument Tables	248-249
Equine Mouth Wedges	70	Instrument Washer	226
Equine Neck Cradle	157	Intensifying Screens	267
Equine Stomach Tubes	213	Intensive Care Units	255
Equine Surgery Table	241	Interlocking Nail System	80
Equine Tooth Rasps	62-64	Iris Lamp	283
ERG-System	32	Iris Scissors	4
Examination Light	243	Irrigating Cannula	206
Examination Table	227-229	IV Stand	203
Expansion Screw	48	K	
Exposure Indicator Tape Strips	223	K-Wire Bender	83
Extension Plates	96	K-Wire Cutter	82-83
External Fixation Bars	73-75, 79	K-Wire Pins	77-78
Eye Implants	41	Kennel	255
Eye Surgery Kit	38	Kennel Runs	257
F		Kidney Bowls	291
Feeding Needles	203	KIRSCHNER-ELLIS Pins	74
Feline Skeleton	304	KIRSCHNER Trocar Pins	74
Femur-Condylar Plates	103	Knee Retractors	87-88
Fibre Optic Cable	167	L	
Filmscribor	278	Lacrimal Needles	205
Fixing Arm	88	Laminectomy Rongeurs	92
Fixing Fluid	276	Lamps	244-246
Flexible Endoscopes	173	Laparoscopes	161
Fold Flat Cages	257	Laparoscopy Instruments	166
FOLEY Catheters	212	Laryngoscopes	141-142
Forceps	10-13, 16, 25, 90, 174, 201, 294, 297-298, 303	Larynx Retractors	23
Fundus Camera	29	Lead Divider	268
G		Lead Gloves/Protective Gloves	273
Gags	55, 57, 122	Ligature Needle	21
Gas Ampoules	223	Light Source	167-168
Gas Steriliser	223	Lights	244-246
GAYMAR T/Pump	238	Lightsource with CCD-Camera	170
Gonioscopy Lenses	31	Lubra-Plates	116
Graft Passers	85-86	M	
Grasping Forceps	25	Magnifying Glasses	33-35
Grids	268	Maintenance and Repair of Equine Dental Equipment	67
Guttapercha Points	48	MAYO Scissors	7-8
H		Medical Cabinet	247
Haematoma Compress	71	MELISEPTOL	226
Hand Switch	183	Meniscal Instruments	92
Handpieces	44, 120,	METZENBAUM Scissors	7-8

	Page		Page
MICRO Scalpel Handles.....	4	Practitioner Stools	236-237
Microscopes	33, 284-286	Pressure Infusor	164-165
Microscope-Accessories.....	286-287	Printer	187
Mini Bone Plates.....	93	Probe-pointed Scissors	5
Mini Compression Plates.....	94	Probes	22
Mini Fragment Plates.....	95	Prophy Paste.....	55
Mobile Stand for Pet Carriers	258	Protection Shield	49
Mobility Carts.....	307	Protective Gloves	123, 273
Molar Cutters	56	Pulsoxymeter.....	146-147
Monitor.....	171	Puncture Adapters	187
Monitoring.....	147-154	PVC Endotracheal Tubes	137
Mouth Gags.....	55, 57, 122	R	
Multi-Parameter-Monitor.....	151	Rack for Collars	156
Multifunction Videosystem.....	168	Radisurgery Scissors.....	199
Myelography Needles.....	205	Radisurgery Accessories.....	196-197
N		Radisurgery Unit.....	195, 198
Nail Clippers	303	Rail Systems.....	232
Navicular Stand	269	Rebreathing Bags.....	143, 145
NCP-Cortical Screws.....	115	Rechargeable Handle.....	157
Needle Boxes	19	Reconstruction Plates.....	100
Needle Holders.....	19-20	REDON-DRAINS.....	210
Needles	17, 205	Reduction Valves.....	130
Negative Threaded Pins	76	Reflex Hammers.....	191
Neuter Instruments.....	295	Refractometer.....	291
Non-Contact Plates (NCP)	115	Respiratory Monitor	153
Nylon Muzzles	313	Restraining Equipment.....	124
O		Restraint Gloves.....	123
Oesophagus Flushing Catheter.....	213	Retinal Camera.....	29
Oesophagus Monitor	153	Retractors.....	22-24, 90
Offset for Probes	183	Rigid Endoscopes.....	164
Operating Gowns.....	311	Rodent Cheek Dilators	55
Operating Table Frame.....	233	Rodent Molar Rasp.....	57
Ophthalmic Instruments.....	37-41	Rodent Mouth Gags	55
Ophthalmoscopes.....	26-27	Rongeurs	92, 164
Orthopaedic Drill.....	81	Rubber Mat.....	233
Orthopaedic Mallets.....	80	S	
Orthopaedic Washers	117	Safety Shield	47
Orthopaedic Wire Twister	85	Sample Retrieval Tube	175
Orthopaedic Kits	108-109	Saw Blades.....	121
Oscillating Saw	9, 120	Scales.....	306-307
Osteo Models	305-306	Scalpel Blades.....	3-4
Osteotomes	89-90	Schirmer Tear Test.....	31
Osteotomy Gauge Set.....	101	Scissors	4-9
Otoscope	171	Screen Cleaner.....	267
Otoscope Head.....	160	Screw racks	113
Otoscope Set.....	159	Scrub Brushes	227
Otoscope Sheath.....	162	Self Retaining Retractors.....	23-24
Oxygen Concentrator	128-129	Self Retaining Rib Spreaders	25
Oxygen Emergency Kit.....	130	Sensors for Pulseoxymeters.....	152
P		Sharpen scissors	8
Padded Plastic Splints.....	313	Sheath	165
Pancarpal Arthrodesis Plates	102	Sheaths and Trocars	165-166, 297
Pantarsal Plates	102	SHOR-LINE Kennels	250-251, 256
Paper for Video Printer	188	SHOR-LINE Kennel Accessories.....	252-254
PC-Based Electrocardiogram.....	192	SHOR-LINE Polykennel	256
PENROSE-DRAIN.....	211	Side Tables	249
Periosteal Elevators.....	26	Skeleton.....	303-304
Pet Carrier	257-258	Skin Stapler	21
Pet Pill Gun.....	313	Slit Illumination Head.....	158
PEZZER Catheters.....	209	Small Animal Scales	306
Pin Cutter.....	85	Small fragment T-Plate	97
Pins.....	75-78	Snares	123
Pin Dispenser	78	Soda Lime	145
Plaster Scissors.....	9	Spay Instruments.....	295
Plate Bending Forceps	104	Specula.....	158-159, 201
Plexiglas Collars	156	Spinal Instruments.....	116
Plexiglass Cassette Tunnel	270	Spinal Needles	205
Pleximeters.....	191	Spray Bottle.....	292
Pneumatic Surgical Motor System	119	Spreadable Specula	159
Positive Threaded Pins.....	75	Stainless Steel Box.....	233
Post Mortem Bags	314	Stainless Steel Bucket.....	64
Practitioner Chairs	236-238	STANDARD Scalpel Handles	3
Practitioner Standing Aid	238	STEINMANN Pins	75-76

Index

	Page		Page
Sterilisation Containers.....	81-82, 219-220	Uterine Flushing Catheters.....	209
Sterilisation Pouches.....	220	Uterine Forceps.....	201
Sterilising Film.....	222	UV-Lamps.....	72
STERISOL UV Light.....	224	V	
Stethoscopes.....	190-191	Vacuclave.....	215
STEVENS Scissors.....	5	Vacuum Support Pump.....	240
Stitch Scissors.....	9	Vacuum Supports.....	239-240
Stitch Cutters.....	9	Vaginal Specula.....	159, 201
Stomach Tubes.....	212	Vaginoscopes.....	160
Suction- and Irrigation Pump.....	163	Vakuum Autoclave.....	216
Suction Pump.....	175	Vaporisers.....	134
Suction Tips.....	122	Ventilator.....	129-130
Surgeons Caps.....	311	Vet Bed.....	259
Surgeons Clothing.....	310	Veterinary Diagnostic Set.....	160
Surgery Drapes.....	308	Videoendoscope.....	172
Surgery Gloves.....	309	Video Otoscope.....	171
Surgery Lights.....	244-246	Video Printer.....	187
Surgery Tables.....	230-231, 234-235, 241	Visits Case.....	297
Surgery Table Tops.....	231	V-Top Surgery Tables.....	231
Surgical Burs.....	121	W	
Surgical Drape.....	309	Walk-on Platform Scales.....	307
Surgical Microscope.....	33	Wall Mount Surgery Table.....	235
Surgical Suction Devices.....	121-122	Water-Treatment Systems.....	216-217
Suture Clips.....	21	Water Container.....	54
Suture Needles.....	17	Wire Cutters.....	85
Syringe and Cannula Dispenser.....	248	Wire Extraction.....	83
Syringe Holder.....	204	Wire Saws.....	89
Syringe Pump.....	203	Wolf Tooth Elevator Kit.....	62
T		WOODS Lamps.....	72
Tables.....	227-231, 234-235, 248-249, 256	Wound Clips.....	21
Tap Handles.....	105	X	
Tattoo Forceps.....	298	X-Ray Accessories.....	266-274, 276-278, 282-283
Tattoo Ink.....	299	X-Ray Cassette.....	267
Tear Test.....	31	X-Ray Chemicals.....	276
Teething Ring.....	140	X-Ray Film.....	266
Tenaculum Forceps.....	25	X-Ray Film Scanner.....	281
Tests for Blood Gas Analyser.....	294	X-Ray Film Viewers.....	283
Test Tubes.....	287	X-Ray Marking.....	278
Thermometers.....	191	X-Ray Positioners.....	268-269
Thoracic Drains.....	211	X-Ray Positioning Aids.....	271-272
Tick Forceps.....	303	X-Ray Processors.....	275
Tie Down Attachments.....	232	X-Ray Stands.....	263-264
Thyroid Protection Shield.....	273	X-Ray Units.....	260-262 279-280, 282
Toggle Pin Instrumentation.....	116	Y	
Tongue Spatula.....	56	Y-Plates.....	103
Tonometer.....	30-31		
Tooth Rasp.....	57		
Tooth Rasps Blades.....	64		
Tourniquets.....	206-207		
Towel Clips.....	12		
TPLO Plates.....	102		
TPLO Saw Blades.....	101		
Tracheal Tubes.....	139		
Transducers.....	180, 182, 186		
Trans Ilias Nut.....	113		
Transport Slings.....	242		
Tray and IV Stand.....	232		
Trays for Autoclaves.....	216		
Trays for Pet Carrier.....	258		
Trephine.....	62		
Trocar Pins.....	77-78		
Tub/Tables.....	256		
U			
ULMER Fixator.....	144		
Ultrasonic Cleaner.....	224-225		
Ultrasonic Doppler.....	154		
Ultrasonic Scalers.....	51-54		
Ultrasound Gel.....	187		
Ultrasound Machines.....	178-179, 181-182, 184-185		
Ultrasound Positioner.....	189		
Ultrasound Table.....	189		
Urinary Catheters.....	207		
Uterine Culture Swabs.....	209-210		

Please copy



Order Form

Fax: +49 7461/96580-91

Phone: +49 7461/96580-55

Name _____
 Clinic Name _____
 Street _____
 Address _____
 Phone _____
 Fax _____
 E-mail _____

Date, Signature _____

We herewith order under the general EICKEMEYER order terms:			
Qty.	Art.No.	Description	Price



EICKEMEYER Medizintechnik für Tierärzte KG
 Eltastraße 8 · D-78532 Tuttlingen · Germany
 Tel: +49 7461/96580-55 · Fax: +49 7461/96580-91
 E-mail: export@eickemeyer.de · Internet: www.eickemeyer.de

Please copy



Order Form

Fax: +49 7461/96580-91

Phone: +49 7461/96580-55

Name _____
 Clinic Name _____
 Street _____
 Address _____
 Phone _____
 Fax _____
 E-mail _____

Date, Signature _____

We herewith order under the general EICKEMEYER order terms:			
Qty.	Art.No.	Description	Price



EICKEMEYER Medizintechnik für Tierärzte KG
 Eltastraße 8 · D-78532 Tuttlingen · Germany
 Tel: +49 7461/96580-55 · Fax: +49 7461/96580-91
 E-mail: export@eickemeyer.de · Internet: www.eickemeyer.de

Order Form

Fax: +49 7461/96580-91

Phone: +49 7461/96580-55

Name _____
 Clinic Name _____
 Street _____
 Address _____
 Phone _____
 Fax _____
 E-mail _____

 Date, Signature

We herewith order under the general EICKEMEYER order terms:

Qty.	Art.No.	Description	Price



EICKEMEYER Medizintechnik für Tierärzte KG
 Eltstraße 8 · D-78532 Tuttlingen · Germany
 Tel: +49 7461/96580-55 · Fax: +49 7461/96580-91
 E-mail: export@eickemeyer.de · Internet: www.eickemeyer.de

Please copy



Order Form

Fax: +49 7461/96580-91

Phone: +49 7461/96580-55

Name _____
 Clinic Name _____
 Street _____
 Address _____
 Phone _____
 Fax _____
 E-mail _____

 Date, Signature

We herewith order under the general EICKEMEYER order terms:

Qty.	Art.No.	Description	Price



EICKEMEYER Medizintechnik für Tierärzte KG
 Eltstraße 8 · D-78532 Tuttlingen · Germany
 Tel: +49 7461/96580-55 · Fax: +49 7461/96580-91
 E-mail: export@eickemeyer.de · Internet: www.eickemeyer.de

Please copy

